

# 2017

## LEVEL OF DEVELOPMENT SPECIFICATION PART I

# BIMFORUM

November 2017

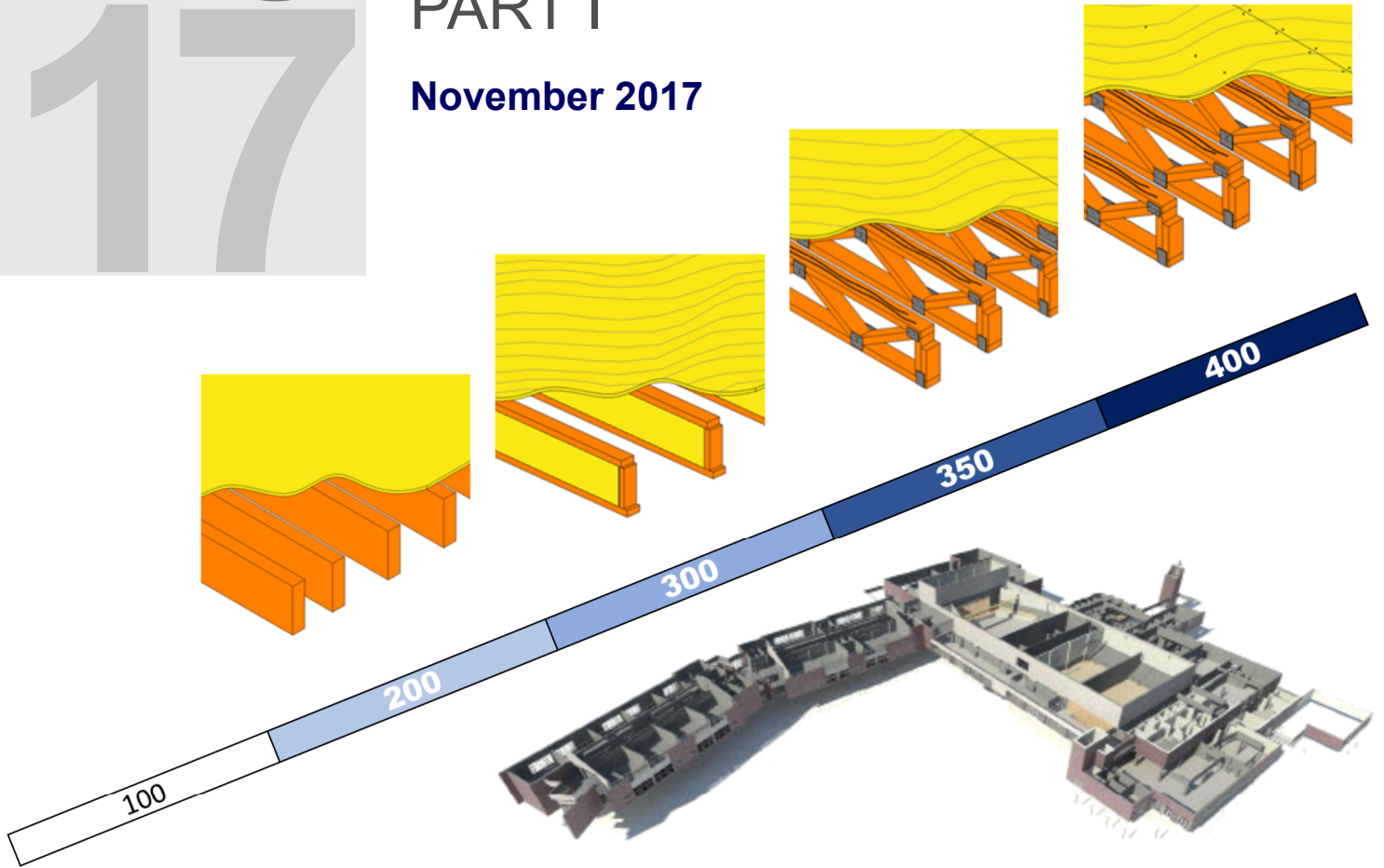

Milestones/Deliverables

	Model Elements	SD	DD	CD	Constr. Coord.	Fabrication
Building Systems	■	■	■	■	■	■
	■	■	■	■	■	■
	■	■	■	■	■	■
	■	■	■	■	■	■
	■	■	■	■	■	■
	■	■	■	■	■	■
	■	■	■	■	■	■
	■	■	■	■	■	■

### PARTICIPATING ORGANIZATIONS

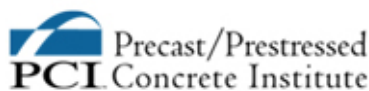

# LOD Spec 2017 Part I

Version: 2017

November 2017

## For Building Information Models

*Nothing contained in this work shall be considered the rendering of legal advice. Readers are responsible for obtaining such advice from their own legal counsel. This work and any forms herein are intended solely for educational and informational purposes.*

*All images are intended to illustrate building conditions in compliance with common building codes. However, the images do not take into account site specific conditions, regional building codes and other important information that may require a material change for specific projects. These illustrations do not make representation for fitness for a particular project nor for code or design compliance.*

**Copyright © 2017 by BIMForum. All rights reserved**

*The LOD Specification Part I and Part II as well as the LOD Specification Guide are made available to the public without charge. In order to maintain the integrity and usefulness of these documents as a reference standard, certain restrictions apply to their use. These documents are licensed to the public under Creative Commons licenses as follows:*

*Part I of this work is licensed under the Creative Commons Attribution-NonCommercial-NoDerivatives 4.0 International License (<http://creativecommons.org/licenses/by-nc-nd/4.0/>).*

*Part II of this work is licensed under the Creative Commons Attribution-NonCommercial 4.0 International License (<http://creativecommons.org/licenses/by-nc/4.0/>).*

*The LOD Spec Guide is licensed under the Creative Commons Attribution-NonCommercial-NoDerivatives 4.0 International License (<http://creativecommons.org/licenses/by-nc-nd/4.0/>).*

*Licensing questions should be directed to [LOD@BIMForum.org](mailto:LOD@BIMForum.org).*

## ACKNOWLEDGEMENTS

Many thanks to all the individuals and organizations who reviewed and contributed to this work, and to the following industry association representatives and co-chairs of the major discipline subgroups who made this document possible:

### Overall Co-Chairs

Jan Reinhardt, Adept Project Delivery

Jim Bedrick, FAIA, AEC Process Engineering

### Domain Co-Chairs

	Design	Construction
<b>Structures</b>	Will Ikerd, PE, LEED AP IKERD Consulting, LLC	David Merrifield Steel Fab, Inc.
<b>Exterior Skin</b>	James Vandezande, AIA HOK	Jon McFarland Wheaton Sprague
<b>Interior Construction</b>	Ron Dellaria, AIA, CSI Collaborative Construction Consultants	Brian Filkins The Beck Group
<b>Conveying</b>	Brian Skripac, Assoc. AIA, LEED AP BD+C Cannon Design	Ken Flannigan, LEED AP KONE
<b>Building Services</b>	Birgitta Foster VDCO Tech	David Francis Murray Company
<b>Civil</b>	Will Ikerd, PE, LEED AP IKERD Consulting, LLC	Gregg Madsen, RPLS Wier & Associates, Inc.
<b>Bridge: Highway &amp; Rail</b>	Will Ikerd, PE, LEED AP IKERD Consulting, LLC	David Merrifield Steel Fab, Inc.
<b>Legal</b>	Carl G. Roberts, Law Offices of Carl G. Roberts LLC	

### Industry Association Representatives

Dmitri Alferieff, Associated General Contractors

Michael Bomba, Esq., American Institute of Architects

## Overall Editing and Graphics Creation

IKERD Consulting, LLC (IKERD.com) & BIMxD Solutions, LLC (BIMxD.com)

## Additional Contributors

In addition, we'd like to thank the many contributors from all sectors of the industry who helped make this specification possible, including:

Andy Jizba, US CAD

Benjamin Crosby, Yates Construction

Bill Klorman, Klorman Construction & ACI 131 BIM Committee Member (Concrete)

Brenda Ikerd, Ikerd Consulting, IKERD.com (Structures, Civil)

Chuck Eastman, Ph.D, Georgia Institute of Technology

David Merrifield, Steel Fab, Inc.

Eloisa Amaya, Ikerd Consulting, IKERD.com (Graphics Editing, Structures, and Cover)

Jamie L. Davis, PE, LEED AP, Ryan Biggs | Clark Davis Engineering & Surveying (Masonry)

Jason P. Lien, PE, Precast Concrete Institute (PCI) BIM Committee, EnCon United (Precast)

Jessica Butcher, Ikerd Consulting, IKERD.com (Graphics Editing, Structures, and Anchors)

Joe Cipra, Vulcraft/Verco Group (Structural Steel Open Web Joists and Metal Deck)

Joe Powell, EIT, Ikerd Consulting, IKERD.com (MEP)

John Russo, AIA, President, US Institute of Building Documentation (Laser Scanning & Level Of Accuracy)

Kirk Capristo, Astorino (Cover)

Lee Garduno, Southland Industries (MEP)

Luke Faulkner, LEED AP, AISC (Structural Steel)

Matthew J. Gomez PE, SE, Gerdau (Structural Steel)

Michael Bolduc, PE (MA), Simpson Gumpertz & Heger (Structural)

Michael Gustafason, PE, Autodesk (Structural)

Michael Mulder, Southland Industries (MEP)

Murat Karakas, Arup (MEP)

Natasha Wright, Ikerd Consulting, IKERD.com (Graphics Editing, Structures, and Anchors)

Paul J. Hause, PE, Structural Consultants Inc. (Structural)

Peter J. Carrato, Ph.D., PE, SE, Bechtel & ACI 131 BIM Committee Chair (Concrete)

R. Wayne Muir, P.E., Structural Consultants Inc. & SEI-CASE BIM Committee Co-Chair (Structures)

Rebecca Stanford, Ikerd Consulting, IKERD.com (Structures)

Roger Becker, PE, SE, Precast Concrete Institute (PCI) Managing Director of Research and Development (Precast)

Scott Babin, ITW Building Components Group (Wood)

Soheil Seiqali, Klorman Construction (Concrete)

Steven Bumbalough, ITW Building Components Group (Wood)

## EXECUTIVE SUMMARY

For a detailed guide on the use of this Specification see [LOD Spec Guide](#).

*The Level of Development (LOD) Specification* is a reference tool intended to improve the quality of communication among users of Building Information Models (BIMs) about the characteristics of elements in models. The *LOD Specification* expands upon the LOD schema developed by the American Institute of Architects (AIA) for its *E202-2009 BIM and Digital Data Exhibit* and updated for the AIA's *G202-2013 Project BIM Protocol Form*<sup>1</sup> by providing definitions and illustrations of BIM elements of different building systems at different stages of their development and use in the design and construction process.

Building Information Modeling presents information about a construction project or structure in the form of three-dimensional graphical representations of elements (e.g., doors, beams, etc.), which can be further associated with information about other characteristics of those elements. It is possible for the graphical representation of an element, taken alone, to suggest that greater accuracy or intention can be attributed to the element than is in fact the case. The AIA's LOD Schema was developed to provide a more systematic way of conveying the extent of reliance that may be placed on an element. Many participants in the design and construction process felt, however, that the industry would benefit from a more detailed treatment of the AIA's brief narrative definitions.

Discussions within the BIMForum led to the creation of a multi-disciplinary task force to develop and maintain the *LOD Specification*. The *LOD Specification* is an organized collection of interpretations of the AIA's LOD definitions describing input and information requirements and providing graphical examples of the different levels of development of a broad variety of building element classes.

Users of the *LOD Specification* are cautioned that it does not prescribe the necessary levels of development for different steps in the construction process. That determination is left to each project team. It is believed, however, that the availability of more precise definitions will reduce the risks of miscommunication among members of project teams when the expectations for different stages in the design and construction process are established, through easier identification of what each member of the team is expected to deliver and greater predictability of the level of effort that is required to create each member's deliverables.

The *LOD Specification* is organized by CSI Unifomat 2010<sup>2</sup>, with the subclasses expanded to Level 4 (and in a few cases to Level 5) to provide detail and clarity to the element definitions. The *LOD Specification* addresses only LOD 100 through LOD 400 of the AIA's LOD Schema, along with a new level – LOD 350 – which was added between LOD 300 and LOD 400 to better address the information levels required for effective trade coordination. The *LOD Specification* does not address LOD 500 since that LOD relates to field verification and is not an indication of progression to a higher level of geometry or information. See below for the Fundamental LOD Definitions.

The *LOD Specification* does not prescribe who the author of a particular component at a given LOD should be, as that will vary from one project to another. However, the document does provide a concise schematic means through the spreadsheet in Part II for a project team to identify model element authors, again in the interest of improving communication among model users. In addition, the *LOD Specification* task force has been working with software developers to provide a means within the software of tagging individual elements within a model with their current LOD level.

The *LOD Specification* is intended as a reference standard, but is also intended to evolve as the use of BIM develops. The Specification is updated annually, and previous versions are maintained on the BIMForum website ([www.bimforum.org/lo](http://www.bimforum.org/lo)). Users are invited to provide comments and recommendations for consideration in future editions. These should be sent by email to [LOD@BIMForum.org](mailto:LOD@BIMForum.org).

---

<sup>1</sup> AIA Contract Document *G202-2013, Building Information Modeling Protocol Form* is part of a series of digital practice documents the AIA published in June 2013. This series consists of *AIA E203™–2013, Building Information Modeling and Digital Data Exhibit*, *AIA G201™–2013, Project Digital Data Protocol Form*, and *AIA G202™–2013, Project Building Information Modeling Protocol Form*. For general information on the documents and downloadable samples see [www.aia.org/digitaldocs](http://www.aia.org/digitaldocs). For executable versions of the documents see <http://www.aia.org/contractdocs>.

<sup>2</sup> UniFormat™ Numbers and Titles used in this publication are from UniFormat™, published by CSI and Construction Specifications Canada (CSC), and are used with permission from CSI. For a more in-depth explanation of UniFormat™ and its use in the construction industry visit <http://www.csinet.org> or contact CSI, 110 South Union Street, Suite 100, Alexandria, VA 22314. (800) 689-2900.

# CONTENTS

EXECUTIVE SUMMARY .....	4
CHANGES FROM 2016 VERSION .....	10
UPDATES OF THIS DOCUMENT .....	12
FUNDAMENTAL LOD DEFINITIONS .....	13
PART I – ELEMENT GEOMETRY .....	15
N/A 36-51 OFFICE RESOURCES .....	15
N/A 36-51 73 11 13 11 19 SPACES .....	15
N/A 36-51 73 11 13 17 11 Horizontal Grids .....	16
N/A 36-51 73 11 13 17 13 Vertical Levels.....	16
A 21-01 SUBSTRUCTURE .....	18
A10 21-01 10 Foundations .....	18
A1010 21-01 10 10 Standard Foundations .....	18
A1020 21-01 10 20 Special Foundations.....	24
A20 21-01 20 Subgrade Enclosures.....	28
A2010 21-01 20 10 Walls for Subgrade Enclosures .....	29
A40 21-01 40 Slabs-on-Grade .....	30
A4010 21-01 40 10 Standard Slabs-on-Grade .....	30
A4020 21-01 40 20 Structural Slabs-on-Grade .....	31
A4030 21-01-40-30 Slab Trenches TBD .....	32
A4040 21-01-40-40 Pits and Bases TBD.....	32
A4090 21-01-40-90 Slab-On-Grade Supplementary Components TBD .....	32
A60 21-01-60 Water and Gas Mitigation TBD .....	33
A6010 21-01-60-10 Building Subdrainage TBD.....	33
A6020 21-01-60-20 Off-Gassing Mitigation TBD .....	33
A90 21-01-90 Substructure Related Activities TBD.....	33
A9010 21-01-90-10 Substructure Excavation TBD.....	33
A9020 21-01-90-20 Construction Dewatering TBD .....	33
A9030 21-01-90-30 Excavation Support TBD .....	33
A9040 21-01-90-40 Soil Treatment TBD .....	33
B 21-02 00 00 SHELL .....	34
B10 21-02 10 Superstructure .....	34
B1010 21-02 10 10 Floor Construction.....	34
B1020 21-02 10 20 Roof Construction .....	56
B1080 21-02 10 80 Stairs .....	57
B20 21-02 20 Exterior Vertical Enclosures.....	64
B2010 21-02 20 10 Exterior Walls .....	65
B2020 21-02 20 20 Exterior Windows .....	78
B2050 21-02 20 50 Exterior Doors and Grilles .....	83
B2070 Exterior Louvers and Vents .....	85
B30 21-02 30 Exterior Horizontal Enclosures.....	87

B3010	21-02 30 10 Roofing.....	87
B3020	21-02 30 20 Roof Appurtenances .....	88
B3040	21-02 30 40 Traffic Bearing Horizontal Enclosures .....	89
B3060	21-02 30 60 Horizontal Openings.....	91
B3080	21-02 30 80 Overhead Exterior Enclosures .....	91
<b>C</b>	<b>21-03 INTERIORS.....</b>	<b>93</b>
C10	21-03 10 Interior Construction.....	93
C1010	21-03 10 10 Interior Partitions .....	93
C1020	21-03 10 20 Interior Windows .....	104
C1030	21-03 10 30 Interior Doors .....	105
C1040	21-03 10 40 Interior Grilles and Gates .....	108
C1060	21-03 10 60 Raised Floor Construction.....	108
C1070	21-03 10 70 Suspended Ceiling Construction .....	109
C1090	21-03 10 90 Interior Specialties.....	111
C20	21-03 20 Interior Finishes .....	113
C2010	21-03 20 10 Wall Finishes.....	113
C2020	21-03 20 20 Interior Fabrications .....	115
C2030	21-03 20 30 Flooring.....	115
C2040	21-03 20 40 Stair Finishes .....	116
C2050	21-03 20 50 Ceiling Finishes.....	117
<b>D</b>	<b>21-04 00 00 SERVICES .....</b>	<b>118</b>
D10	21-04 10 Conveying.....	118
D1010	21-04 10 10 Vertical Conveying Systems.....	118
D1030	21-04 10 30 Horizontal Conveying .....	122
D1050	21-04 10 50 Material Handling .....	122
D1080	21-04 10 80 Operable Access Systems .....	126
D20	21-04 20 Plumbing.....	126
D2010	21-04 20 10 Domestic Water Distribution.....	126
D2020	21-04 20 20 Sanitary Drainage .....	132
D2030	21-04 20 30 Building Support Plumbing Systems .....	134
D2050	21-04 20 50 General Service Compressed-Air.....	139
D2060	21-04 20 60 Process Support Plumbing Systems .....	139
D30	21-04 30 Heating, Ventilation, and Air Conditioning (HVAC) .....	141
D3010	21-04 30 10 Facility Fuel Systems .....	141
D3020	21-04 30 20 Heating Systems .....	144
D3030	21-04 30 30 Cooling Systems .....	146
D3050	21-04 30 50 Facility HVAC Distribution Systems .....	150
D3060	21-04 30 60 Ventilation .....	153
D3070	21-04 30 70 Special Purpose HVAC Systems .....	156
D40	21-04 40 Fire Protection .....	157
D4010	21-04 40 10 Fire Suppression .....	157
D4030	21-04 40 30 Fire Protection Specialties.....	159

D50	21-04 50 Electrical .....	160
D5010	21-04 50 10 Facility Power Generation .....	160
D5020	21-04 50 20 Electrical Service and Distribution .....	162
D5030	21-04 50 30 General Purpose Electrical Power .....	165
D5040	21-04 50 40 Lighting .....	167
D5080	21-04 50 80 Miscellaneous Electrical Systems .....	169
D60	21-04 60 Communications .....	170
D6010	21-04 60 10 Data Communications .....	170
D6020	21-04 60 20 Voice Communications .....	170
D6030	21-04 60 30 Audio-Video Communication .....	171
D6060	21-04 60 60 Distributed Communications and Monitoring .....	171
D6090	21-04 60 90 Communications Supplementary Components .....	171
D70	21-04 70 Electronic Safety and Security .....	171
D7010	21-04 70 10 Access Control and Intrusion Detection .....	171
D7030	21-04 70 30 Electronic Surveillance .....	171
D7050	21-04 70 50 Detection and Alarm .....	171
D7070	21-04 70 70 Electronic Monitoring and Control .....	171
D7090	21-04 70 90 Electronic Safety and Security Supplementary Components .....	172
D80	21-04 80 Integrated Automation .....	172
D8010	21-04 80 10 Integrated Automation Facility Controls .....	172
E	21-05 00 00 EQUIPMENT & FURNISHINGS .....	173
E10	21-05 10 Equipment .....	173
E1010	21-05 10 10 Vehicle and Pedestrian Equipment .....	173
E1030	21-05 10 30 Commercial Equipment .....	174
E1040	21-05 10 40 Institutional Equipment .....	176
E1060	21-05 10 60 Residential Equipment .....	177
E1070	21-05 10 70 Entertainment and Recreational Equipment .....	177
E1090	21-05 10 90 Other Equipment Associated Masterformat Sections: 11 90 00 .....	178
E20	21-05 20 Furnishings .....	178
E2010	21-05 20 10 Fixed Furnishings .....	179
E2050	21-05 20 50 Movable Furnishings .....	180
F	21-06 00 00 SPECIAL CONSTRUCTION & DEMOLITION .....	182
F10	21-06 10 Special Construction .....	182
F1010	21-06 10 10 Integrated Construction .....	182
F1020	21-06 10 20 Special Structures Associated Masterformat Sections: 13 30 00 / 01 88 13 .....	182
F1030	21-06 10 30 Special Function Construction Associated Masterformat Sections: .....	190
F1050	21-06 10 50 Special Facility Components Associated Masterformat Sections: .....	190
F1060	21-06 10 60 Athletic and Recreational Special Construction .....	190
F1080	21-06 10 80 Special Instrumentation .....	191
F20	21-06 20 Facility Remediation Associated Masterformat Sections: .....	191
F2010	21-06 20 10 Hazardous Materials Remediation .....	191
F30	21-06 30 Demolition .....	191



F3010	21-06 30 10	Structure Demolition.....	191
F3030	21-06 30 30	Selective Demolition.....	191
F3050	21-06 30 50	Structure Moving.....	191
G10	21-07 10	Site Preparation.....	191
G1010	21-07 10 10	Site Clearing.....	192
G1020	21-07 10 20	Site Elements Demolition.....	192
G1030	21-07 10 30	Site Element Relocations.....	192
G1050	21-07 10 50	Site Remediation.....	192
G1070	21-07 10 70	Site Earthwork.....	192
G20	21-07 20	Site Improvements.....	193
G2010	21-07 20 10	Roadways.....	194
G2020	21-07 20 20	Parking Lots.....	194
G2030	21-07 20 30	Pedestrian Plazas and Walkways.....	195
G2040	21-07 20 40	Airfields.....	195
G2050	21-07 20 50	Athletic, Recreational, and Playfield Areas.....	195
G2060	21-07 20 60	Site Development.....	195
G2080	21-07 20 80	Landscaping.....	195
G30	21-07 30	Liquid and Gas Site Utilities.....	195
G3010	21-07 30 10	Water Utilities.....	196
G3020	21-07 30 20	Sanitary Sewerage Utilities.....	196
G3030	21-07 30 30	Storm Drainage Utilities.....	197
G3050	21-07 30 50	Site Energy Distribution.....	197
G3060	21-07 30 60	Site Fuel Distribution.....	197
G3090	21-07 30 90	Liquid and Gas Site Utilities Supplementary Components.....	197
G40	21-07 40	Electrical Site Improvements.....	197
G4050	21-07 40 50	Site Lighting.....	199
G50	21-07 50	Site Communications.....	199
G5010		– Site Communications Systems.....	200
G90	21-07 90	Miscellaneous Site Construction.....	200
G9010	21-07 90 10	Tunnels.....	200
N/A	23-13	STRUCTURAL AND EXTERIOR ENCLOSURE PRODUCTS.....	202
N/A	23-13-23	Mechanical Fasteners, Adhesives, and Sealants.....	202
N/A	23-13 23 11	Mechanical Fasteners – L-Bolt.....	202
N/A	23-13 23 11	Mechanical Fasteners – J-Bolt.....	204
N/A	23-13 23 11	Mechanical Fasteners – Hex Head Bolt with Washer.....	205
N/A	23-13 23 11	Mechanical Fasteners – Welded Headed Stud Bolt.....	207
N/A	23-13 23 11	Mechanical Fasteners – Adhesive Anchor.....	208
N/A	23-13 23 11	Mechanical Fasteners – Undercut Anchor.....	210
N/A	23-13 23 11	Mechanical Fasteners – Torque-controlled Expansion Anchor (Sleeve Type).....	212
N/A	23-13 23 11	Mechanical Fasteners – Torque-controlled Expansion Anchor (Stud Type).....	214
N/A	23-13 23 11	Mechanical Fasteners – Drop-in Type Displacement-Controlled Expansion Anchor.....	216
N/A	23-13 31	Structural Concrete Products.....	218

N/A	23-13 31 17 Formwork– Concrete Column.....	218
N/A	23-13 31 17 Formwork– Concrete Slab.....	220
CIVIL	.....	222
	Highway Bridges Precast Structural I Girder (Concrete) .....	222
	Highway Bridge Girder Steel .....	225
	Railroad Bridges Precast Structural I Girder (Concrete).....	226
	Railroad Bridge Girder Steel.....	228



## CHANGES FROM 2016 VERSION

Note – Changes in the Element Geometry section are indicated with a change bar in the left margin. Items such as grammar corrections, added Unifomat descriptions, added Masterformat references, added or upgraded graphics, minor corrections/additions, etc. are marked with a bar but not detailed in this section.

### General notes

#### Non-Graphic Information

All calls for non-graphic information have been deleted from Part I and addressed in Part II

#### “No-fly zones”

Where zones that are not to be penetrated by other elements are required by code, operational, or structural considerations (door swings, electrical panel access clearance, foundation element areas or bearing influence, etc.), an item has been added to LOD 300 definitions calling for the zones to be either modeled to facilitate clash detection or accommodated by model-checking software.

#### Opening Elements (doors, windows, etc.)

Existing LOD 350 calls for modeling of rough opening deleted, moved to definitions of walls, floors, and roofs.

#### Openings and Penetrations and Similar Elements

LOD 300 definitions have been adjusted to call for major openings such as windows, doors, and large mechanical elements to be modeled to nominal dimensions.

LOD 350 definitions have been adjusted to call for all penetrations to be modeled to rough opening dimensions.

Where elements such as MEP distribution components penetrate other elements such as walls, the existing LOD 350 calls for modeling of the penetration element itself (e.g. a sleeve) have been clarified.

### Specific Changes

Introduction		The Introduction has been removed and provided in a separate document – <i>LOD Spec 2017 Guide</i> . This Document also includes white papers on use of the spec.
Executive Summary		Added
Fundamental LOD Definitions – LOD 300		Call for element location added
<b>Unifomat</b>	<b>Omniclass</b>	
N/A	36-51 73 11 13 11 19	Spaces – Added
N/A	36-51 73 11 13 17 11	Horizontal Grids – Added
N/A	36-51 73 11 13 17 13	Vertical Levels - Added
A10	21-01 10	Foundations – LOD 200. Provision for location added
A1020.10.10	21-01 10 20 20	Helical Piles and Piers – Added
A4010	21-01 40 10	Standard Slabs-on-Grade <ul style="list-style-type: none"> <li>• LOD 300. Provision for openings added</li> <li>• LOD 400. Provision for fully modeled rebar added</li> </ul>

B1020	21-02 10 20	Roof Construction – logic clarification added: <ul style="list-style-type: none"> <li>• If modeling roof as a single composite element including structure use B1020</li> <li>• If modeling individual layers as separate elements use: <ul style="list-style-type: none"> <li>○ B1020.10 Roof Structural Frame</li> <li>○ B1020.20 Roof Decks, Slabs, and Sheathing</li> </ul> </li> </ul>
B1020.20	21-02 10 20 20	Roof Decks, Slabs, and Sheathing – Detail added
B1080.70	21-02 10 80 70	Metal Walkways – Detail added
B2010	21-02 20 10	Exterior Walls – logic clarification added: <ul style="list-style-type: none"> <li>• If modeling wall as a single composite element use B2010</li> <li>• If modeling individual layers as separate elements use: <ul style="list-style-type: none"> <li>○ B2010.10 Exterior Wall Veneer</li> <li>○ B2010.20 Exterior Wall Construction</li> <li>○ B2010.30 Exterior Wall Interior Skin</li> </ul> </li> </ul>
B2010	21-02 20 10	Exterior Walls – LOD 350. Requirement for hosted objects to be at LOD 350 deleted.
B2010.20.10	21-02 20 10 10	Exterior Wall Construction (Wood) – Previously B2010
B2010.20.20	21-02 20 10 20	Exterior Wall Construction (Cold-Form Metal Framoing) – Previously B2010
B2010.20.30	21-02 20 10 20 30	Exterior Wall Construction (Masonry) – Previously B2010
B2010.20.40	21-02 20 10 20 40	Exterior Wall Construction (Concrete) – Previously B2010
B2010.30	21-02 20 10 30	Exterior Wall Interior Skin <ul style="list-style-type: none"> <li>• LOD 100 – Changed to N/A</li> <li>• LOD 200 – Detail added</li> <li>• LOD 300 – Detail added</li> </ul>
B2020.30	21-02 20 20 30	Exterior Window Wall – LOD 300. “Structural support systems of wall to be modeled” deleted – addressed in wall element definitions
B3010	21-02 30 10	Roofing – Detail added
D1010.10	21-04 10 10 10	Elevators – Added detail
G1070.10	21-07 10 70 10	Grading – Added
N/A	23-13 23 11	Mechanical Fasteners – Added
N/A	23-13 31 17	Formwork - Added

## UPDATES OF THIS DOCUMENT

While this document is intended as a reference that can be cited in agreements such as contracts and BIM execution plans, it is recognized that the use of BIM in design and construction is evolving. To accommodate this evolution this document will be updated periodically in clearly identifiable versions. A project can adopt a specific version and then has the option to remain with that version or update if a new version is published. Initially the target update frequency is annually, but that may change in the future. In addition, interim updates may be issued if needed.

## Revision History

11/07/17	Level of Development Specification 2017	
08/25/17	Level of Development Specification 2017 DRAFT FOR PUBLIC COMMENT	
10/17/16	Level of Development Specification 2016	
08/25/16	Level of Development Specification 2016 DRAFT FOR PUBLIC COMMENT	Definitions have not been changed except for minor grammatical corrections and formatting. Engineered metal building structures, precast concrete, highway and rail road bridge content moved from Appendix to main body.
10/30/15	Level of Development Specification 2015	Definitions have not been changed except for minor grammatical corrections and formatting. New content released as an Appendix to Part A for engineered metal building structures, precast concrete, highway bridge content and rail road bridge content.
4/30/15	Level of Development Specification 2015 DRAFT FOR PUBLIC COMMENT	Definitions have not been changed except for minor grammatical corrections and formatting. Part B, Model Element Table, and Attribute Tables were added.
12/30/14	Level of Development Specification 2014	Definitions have not been changed except for minor grammatical corrections and formatting. Images and image notes have been added in <i>blue italics font</i> .
8/22/13	Level of Development Specification 2013	
4/24/13	Initial draft for public review	

## Revision Process

### Public Comment

Each new version is first released as a draft for public comment. Feedback is evaluated and resolved prior to the publishing of the official version.

### Appendix

An increasing number of professional organizations are adopting this Specification and providing additional content relating to their domains. To accommodate information that becomes available after the public-comment release but prior to the final release, content is developed in collaboration with industry organizations and leading expert practitioners, and then vetted by the LOD working group. This content is released as an Appendix to Part A and as additional identified Attribute Table tabs in Part B. The new content is then integrated into the next public comment draft.

## FUNDAMENTAL LOD DEFINITIONS<sup>3</sup>

### LOD 100

*The Model Element may be graphically represented in the Model with a symbol or other generic representation, but does not satisfy the requirements for LOD 200. Information related to the Model Element (i.e. cost per square foot, tonnage of HVAC, etc.) can be derived from other Model Elements.*

**BIMForum Interpretation:** LOD 100 elements are not geometric representations. Examples are information attached to other model elements or symbols showing the existence of a component but not its shape, size, or precise location. Any information derived from LOD 100 elements must be considered approximate.

### LOD 200

*The Model Element is graphically represented within the Model as a generic system, object, or assembly with approximate quantities, size, shape, location, and orientation. Non-graphic information may also be attached to the Model Element.*

**BIMForum interpretation:** At this LOD elements are generic placeholders. They may be recognizable as the components they represent, or they may be volumes for space reservation. Any information derived from LOD 200 elements must be considered approximate.

### LOD 300

*The Model Element is graphically represented within the Model as a specific system, object or assembly in terms of quantity, size, shape, location, and orientation. Non-graphic information may also be attached to the Model Element.*

**BIMForum interpretation:** The quantity, size, shape, location, and orientation of the element as designed can be measured directly from the model without referring to non-modeled information such as notes or dimension call-outs. The project origin is defined and the element is located accurately with respect to the project origin.

### LOD 350

*The Model Element is graphically represented within the Model as a specific system, object, or assembly in terms of quantity, size, shape, location, orientation, and interfaces with other building systems. Non-graphic information may also be attached to the Model Element.*

**BIMForum interpretation.** Parts necessary for coordination of the element with nearby or attached elements are modeled. These parts will include such items as supports and connections. The quantity, size, shape, location, and orientation of the element as designed can be measured directly from the model without referring to non-modeled information such as notes or dimension call-outs.

### LOD 400

*The Model Element is graphically represented within the Model as a specific system, object or assembly in terms of size, shape, location, quantity, and orientation with detailing, fabrication, assembly, and installation information. Non-graphic information may also be attached to the Model Element.*

**BIMForum interpretation.** An LOD 400 element is modeled at sufficient detail and accuracy for fabrication of the represented component. The quantity, size, shape, location, and orientation of the element as designed can be measured directly from the model without referring to non-modeled information such as notes or dimension call-outs.

---

<sup>3</sup> The definitions for LOD 100, 200, 300, 400, and 500 included in this Specification represent the updated language that appears in the AIA's most recent BIM protocol document, *G202-2013, Building Information Modeling Protocol Form*. The LOD 100, 200, 300, 400 and 500 definitions are produced by the AIA and have been used by permission. Copyright © 2013. The American Institute of Architects. All rights reserved. LOD 350 was developed by the BIMForum working group. Copyright © 2013. The BIMForum and the American Institute of Architects. All rights reserved.

## LOD 500

*The Model Element is a field verified representation in terms of size, shape, location, quantity, and orientation. Non-graphic information may also be attached to the Model Elements.*

BIMForum interpretation. Since LOD 500 relates to field verification and is not an indication of progression to a higher level of model element geometry or non-graphic information, this Specification does not define or illustrate it.

## Example – Light Fixture:

- 1) 100 cost/sf attached to floor slabs
- 2) 200 light fixture, generic/approximate size/shape/location
- 3) 300 Design specified 2x4 troffer, specific size/shape/location
- 4) 350 Actual model, Lightolier DPA2G12LS232, specific size/shape/location
- 5) 400 As 350, plus special mounting details, as in a decorative soffit

Uniformat Omniclass

# PART I – ELEMENT GEOMETRY

## N/A 36-51 OFFICE RESOURCES

### N/A 36-51 73 11 13 11 19 SPACES

Associated Masterformat Sections: N/A

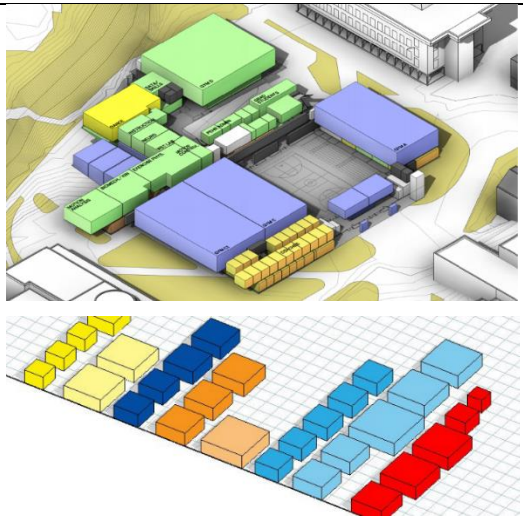
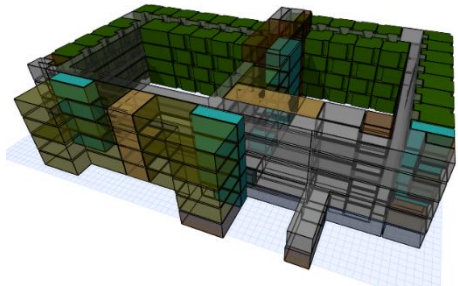
<p>100</p>	<p>Spaces are modeled as generic objects with approximate size, shape and location. This level is typically appropriate for design of spatial requirements where space objects are placed in a model either in a random manner for quantification or in a 'blocking and stacking' process.</p> <p>Bounding elements are not required, but may be needed if specific dimensions are desired.</p> <p>Element modeling to include:</p> <ul style="list-style-type: none"> <li>• Space object based on area required by program or brief.</li> <li>•</li> </ul>	 <p>From <a href="http://revitaddons.blogspot.com/2014/02/free-space-planning-massing-from-excel.html">http://revitaddons.blogspot.com/2014/02/free-space-planning-massing-from-excel.html</a></p>
<p>200</p>	<p>Spaces are modeled or placed with bounding elements such as walls and columns that are at a minimum of LOD200. Perimeter and area of spaces are calculated with respect to the bounding elements.</p> <p>LOD of spaces shall not exceed the LOD of the bounding elements. For example, if interior partitions are defined at LOD200, the space objects for the project cannot be delivered at LOD300.</p> <p>Element modeling to include:</p> <ul style="list-style-type: none"> <li>• Vertical bounding elements at LOD200</li> <li>• Space objects that automatically associate with vertical bounding elements</li> </ul>	 <p>From <a href="http://cad-3d.blogspot.com/2012/06/improve-usage-of-bim-during-early.html">http://cad-3d.blogspot.com/2012/06/improve-usage-of-bim-during-early.html</a></p>
<p>300</p>	<p>Spaces are modeled or placed with bounding elements that are at a minimum of LOD300. Perimeter and area of spaces are calculated with respect to the bounding elements.</p> <p>Element modeling to include:</p>	



# Unifomat Omniclass

	<ol style="list-style-type: none"> <li>1) Vertical bounding elements at LOD300</li> <li>2) Space objects that automatically associate with vertical bounding elements</li> </ol>	
350	<p><i>Comply with the LOD300 requirements.</i></p> <p>Volume of the space is accurately calculated to the nearest horizontal finish surface such as a ceiling or underside of slab above.</p> <p>Element modeling to include:</p> <ol style="list-style-type: none"> <li>1) Vertical bounding elements to minimum LOD300</li> <li>2) Horizontal bounding elements such as ceilings or slabs</li> <li>3) Space objects that automatically associate with vertical and horizontal bounding elements</li> </ol>	

N/A                      36-51 73 11 13 17 11  
 N/A                      36-51 73 11 13 17 13

Horizontal Grids  
Vertical Levels

*Includes: Grids and elevations used to coordinate and annotate models.*

100		
200	<p>Grids &amp; Elevations</p> <p>Equipment, Building, Campus, Civil, and GIS is approximate in its relation to the content in the given model.</p>	<p><i>LOD 200 Grids &amp; Elevations</i></p>

# Unifomat Omniclass

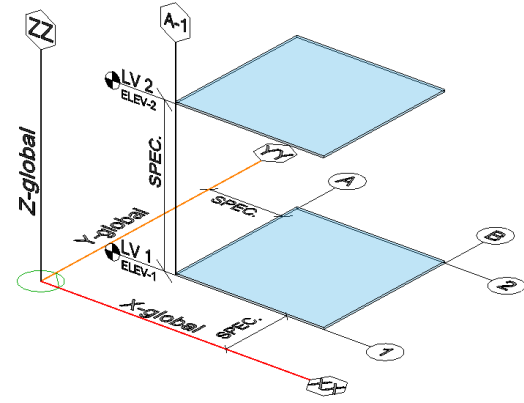
300	<p>Grids &amp; Elevations</p> <p>Equipment, Building, Campus, Civil, and GIS is <i>specific</i> in its relation to the content in the given model.</p>	 <p>The diagram illustrates the LOD 300 Grids &amp; Elevations. It shows two levels, LV 1 (ELEV-1) and LV 2 (ELEV-2), represented by blue planes. The vertical axis is labeled 'Z-global' with a 'ZZ' icon. The horizontal axes are 'Y-global' and 'X-global'. Grid lines are labeled 'A-1' through '10'. Specific grid lines are also labeled 'SPEC.'. The diagram shows the relationship between the levels and the grid lines.</p> <p>LOD 300 Grids &amp; Elevations</p>
-----	--	---

## Uniformat Omniclass

### A 21-01 SUBSTRUCTURE

Associated Masterformat Sections: 01 82 00

#### A10 21-01 10 Foundations

Associated Masterformat Sections: 01 82 13

100	Assumptions for foundations are included in other modeled elements such as an architectural floor element or volumetric mass that contains layer for assumed structural framing depth.  Or, schematic elements that are not distinguishable by type or material. Assembly depth/thickness and locations still flexible.	
200	Element modeling to include: <ul style="list-style-type: none"> <li>• Approximate size and shape of foundation element</li> <li>• Structural building grids for local project coordinate system are defined in model and approximately coordinated with civil coordinate .</li> </ul>	

#### A1010 21-01 10 10 Standard Foundations

*Includes: Formwork, concrete, masonry and reinforcement. Includes Standard Foundation Supplementary Components as appropriate. May Include: Related Activities: Excavation, dewatering, excavation support systems, backfill and compaction, and soil treatment.*

Note – for formwork see [Structural Concrete Products](#)

Associated Masterformat Sections: 01 82 13

100	See <a href="#">A10</a>	
200	See <a href="#">A10</a>	
300	Elements are modeled to the design-specified size and shape of the foundation.  Element modeling to include: <ul style="list-style-type: none"> <li>• Overall size and geometry of the foundation element</li> <li>• Sloping surfaces or floor depressions</li> <li>• External dimensions of the members</li> <li>• Main openings such as elevators and other shafts</li> </ul>	

# Unifomat Omniclass

## A1010.10 21-01 10 10 10 Wall Foundations (Shallow Foundations)

Associated Masterformat Sections: 03 30 00 / 03 40 00 / 04 20 00 / 06 14 00

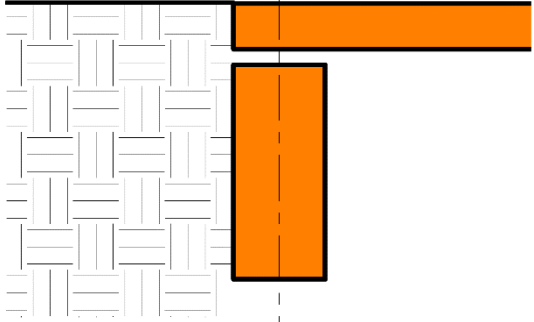
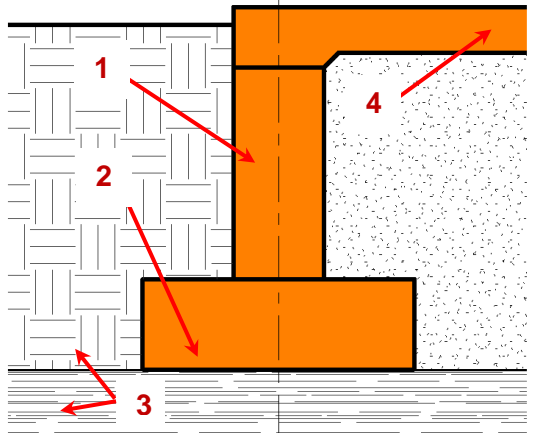
100	See <a href="#">A10</a>	
200	<p>See <a href="#">A10</a></p> <p><i>Image Notes:</i></p> <ul style="list-style-type: none"> <li>• <i>Generic wall foundation is modeled.</i></li> <li>• <i>Site is generically modeled from geotechnical information in geotechnical report.</i></li> </ul>	 <p>1 A1010.10-LOD-200 Wall Foundation</p>
300	<p>Element modeling to include:</p> <ol style="list-style-type: none"> <li>1) Overall size and geometry of the foundation element</li> <li>2) Sloping surfaces.</li> <li>3) External dimensions of the members</li> <li>4) Geotechnical bearing strata elevation is modeled from geotechnical report.</li> <li>5) Area of bearing influence – modeled or accommodated by model checking software</li> </ol> <p><i>Image Notes:</i></p> <ol style="list-style-type: none"> <li>6) <i>Wall foundation sizes are accurately modeled with footings where applicable.</i></li> <li>7) <i>Bearing elevation is modeled from the geotechnical report.</i></li> <li>8) <i>Geotechnical regions are shown for context and not required to be modeled as part of this element at this LOD.</i></li> <li>9) <i>See slab on grade for related conditions at this LOD.</i></li> </ol>	 <p>2 A1010.10-LOD-300 Wall Foundation</p>

# Unifomat Omniclass

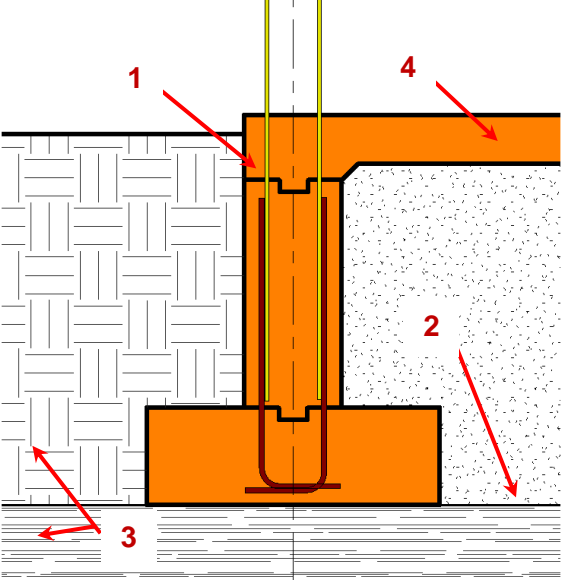
<p>350</p>	<p>Element modeling to include:</p> <ol style="list-style-type: none"> <li>1) Location of sleeve penetrations</li> <li>2) Pour joints</li> <li>3) Chamfer</li> <li>4) Moisture retarder</li> <li>5) Dowels</li> <li>6) All exposed embeds or reinforcement such as lintels</li> <li>7) Expansion joints</li> <li>8) Geotechnical Bearing Strata is modeled from geotechnical report estimates.</li> </ol> <p><i>Image Notes:</i></p> <p>9) <i>Grade beam sizes are modeled with interfaces to other systems such as but not limited to slab turn downs, key-ways between concrete pours, construction joints and reinforcing dowels into adjacent pours.</i></p> <p>10) <i>Bearing elevation is modeled from the geotechnical report with the addition on interface elements such as void boxes where applicable.</i></p> <p>11) <i>Geotechnical regions are shown for context and not required to be modeled as part of this element at this LOD.</i></p> <p>12) <i>See slab on grade for related conditions at this LOD.</i></p>	 <p>3 A1010.10-LOD-350 Wall Foundations (Shallow Foundations)</p>
<p>400</p>	<p>Element modeling to include:</p> <ul style="list-style-type: none"> <li>• Rebar including hooks and lap splices</li> <li>• Dowels</li> <li>• Coursing for unit masonry defined</li> <li>• Waterproofing</li> </ul>	



## A1010.30 21-01 10 10 30 Column Foundations (Deep Foundations)

Associated Masterformat Sections: 03 30 00

<p>100</p>	<p>See <a href="#">A10</a></p>	
<p>200</p>	<p>See <a href="#">A10</a></p>	

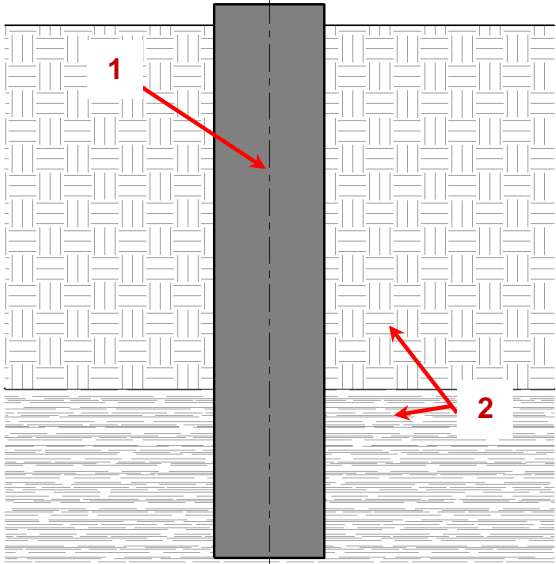

# Uniformat Omniclass

<p>300</p>	<p>Element modeling to include:</p> <ol style="list-style-type: none"><li>1) Assumed bearing depth per geotechnical report with designed penetration geometry modeled.</li><li>2) Top of Pier</li><li>3) Size of Pier</li><li>4) Area of bearing influence - modeled or accommodated by model checking software</li></ol> <p><i>Image Notes:</i></p> <ol style="list-style-type: none"><li>5) Pier sizes are accurately modeled with top of pier elevation, estimated depth to bearing and specified depth of penetration into bearing strata.</li><li>6) Geotechnical regions are shown for context and not required to be modeled as part of this element at this LOD.</li></ol>	 <p>4 A1010.30-LOD-300 Column Foundations (Deep Foundations)</p> 
------------	--	---

# Uniformat Omniclass

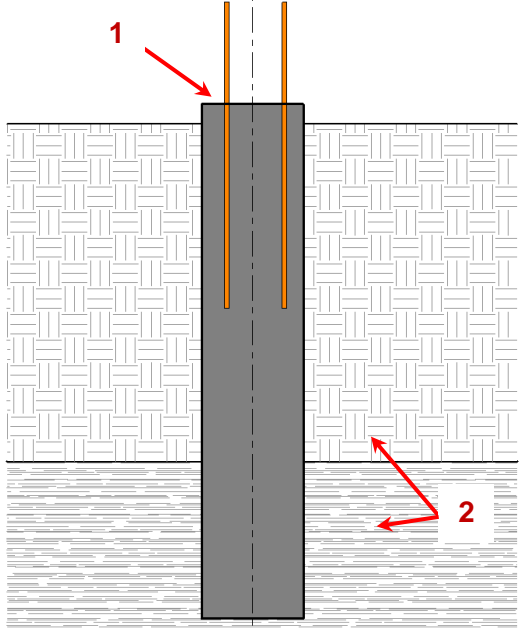
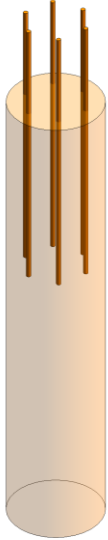
<p>350</p>	<p>Element modeling to include:</p> <ul style="list-style-type: none"><li>• Actual Top of Pier (TOP) and expected Bottom of Pier (BOT) modeled per engineer's review of site conditions</li><li>• Foundation dowel locations and anchor rods if applicable.</li></ul> <p><i>Image Notes:</i></p> <ul style="list-style-type: none"><li>• <i>Pier sizes are accurately modeled with interfaces to other systems such as but not limited to slab turn downs, key-ways between concrete pours, construction joints and reinforcing dowels into adjacent pours.</i></li><li>• <i>Geotechnical regions are shown for context and not required to be modeled as part of this element at this LOD.</i></li></ul>	 <p>5 A1010.30-LOD-350 Column Foundations</p> 
------------	---	--

# Unifomat Omniclass

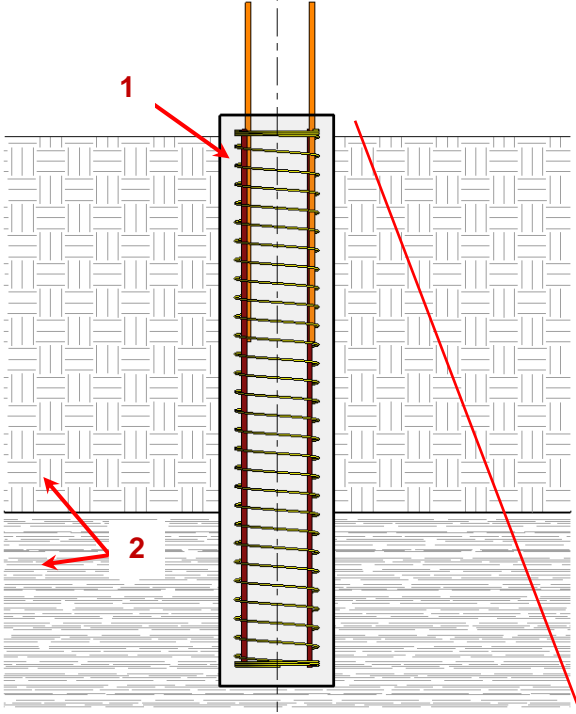
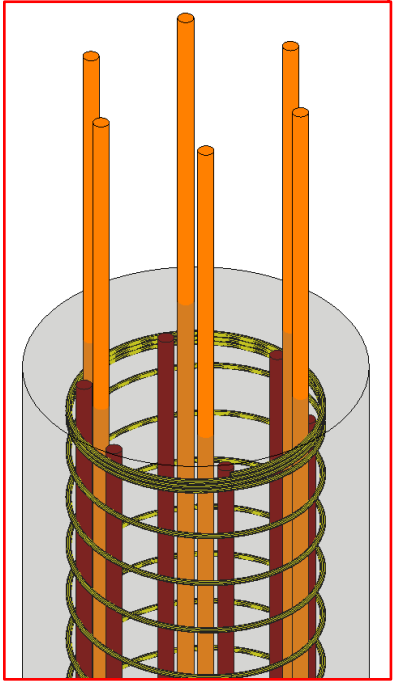
<p>400</p>	<p>Element modeling to include:</p> <ul style="list-style-type: none"><li>• Depth to bearing stratum</li><li>• Penetration into bearing stratum</li><li>• Locations of lap splices</li><li>• Rebar including hooks and lap splices</li><li>• Dowels</li><li>• Pier sled or Pier wheel for side clear cover</li><li>• Pier bolster for bottom clear cover</li></ul> <p><i>Image Notes:</i></p> <ul style="list-style-type: none"><li>• <i>Pier modeling is developed to include all fabrication content that is part of the element.</i></li><li>• <i>Geotechnical regions are shown for context and not required to be modeled as part of this element at this LOD.</i></li><li>• <i>Pier sled, pier wheel, pier bolsters and other related items are not shown in image for clarity.</i></li></ul>	  <p>6 A1010.30-LOD-400 Column Foundations</p>
------------	---	--



## Unifomat Omniclass

A1010.90      21-01 10 10 90      Standard Foundation Supplementary Components      TBD

### A1020      21-01 10 20      Special Foundations

*Includes: Drilling, casing, bell bottom, excavation, dewatering, removal of excavated, materials, reinforcing, and concrete. Drilled Piers, Driven Piles, Mat Foundation, elevator pits.*

Associated Masterformat Sections: 31 60 00

100	See <a href="#">A10</a>	
200	See <a href="#">A10</a>	
300	See <a href="#">A1010</a> 1) <a href="#">Elevator pit slabs are sloped correctly</a> 2) Sump pits are shown at correct locations and geometries	
350	Element modeling to include: <ul style="list-style-type: none"> <li>• Location and size of sleeve penetrations and MEP openings</li> <li>• Chamfer</li> <li>• Pour joints</li> <li>• Dowels</li> <li>• All elements needed for cross-trade collaboration are to be modeled</li> <li>• Actual location and shape of structural element</li> <li>• Exposed embeds or reinforcement such as lintels</li> <li>• Penetrations detailed and modeled</li> <li>• Expansion joints</li> </ul>	
400	Element modeling to include: <ul style="list-style-type: none"> <li>• Rebar detailing including hooks and lap splices</li> <li>• Dowels</li> <li>• Moisture retarder</li> <li>• Coursing for unit masonry defined</li> <li>• Waterproofing</li> </ul>	

A1020.10      21-01 10 20 20      Driven Piles      TBD



*Includes: Piles, pile driving, pile cut off, pile testing.*

# Unifomat Omniclass

A1020.10.10 21-01 10 20 20

Helical Piles, Helical Piers

Associated Masterformat Sections: N/A

100	See <a href="#">A10</a>	
200	See <a href="#">A10</a>  Helical Pile	 <p style="text-align: center;"><i>A1020.10.10 LOD 200 Helical Piers</i></p>
300	<p>Element modeling to include:</p> <ul style="list-style-type: none"> <li>• Pile system type</li> <li>• Pile material</li> <li>• Coating</li> <li>• Influence area modeled or accommodated by model checking software</li> </ul>	 <p style="text-align: center;"><i>A1020.10.10 LOD 300 Helical Piers</i></p>

# Unifomat Omniclass

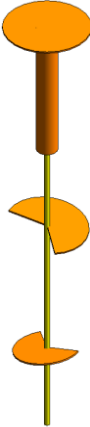
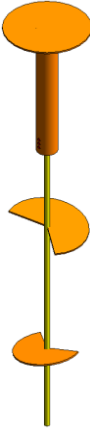
350	<p>Element modeling to include:</p> <ul style="list-style-type: none"> <li>• Spacing</li> <li>• Plate Size</li> <li>• Bearing Strata</li> </ul>	 <p><i>A1020.10.10 LOD 350 Helical Piers</i></p>
400	<p>Element modeling to include:</p> <ul style="list-style-type: none"> <li>• Full fabrication connections</li> </ul>	 <p><i>A1020.10.10 LOD 400 Helical Piers</i></p>

A1020.20	21-01 10 20 20	Caissons	TBD
A1020.30	21-01 10 20 30	Special Foundation Walls	TBD
A1020.40	21-01 10 20 40	Foundation Anchors	TBD
A1020.50	21-01 10 20 50	Underpinning	TBD

## Unifomat Omniclass

A1020.60 21-01 10 20 60 Raft Foundations TBD

A1020.70 21-01 10 20 70 Pile Caps TBD

A1020.80 21-01 10 20 80 Grade Beams

*Includes: Formwork, reinforcement, and concrete.*

Associated Masterformat Sections: 03 30 00

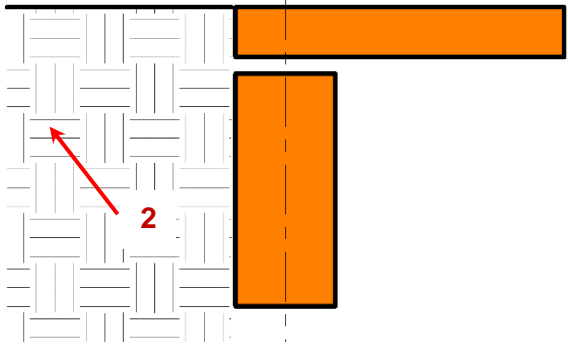
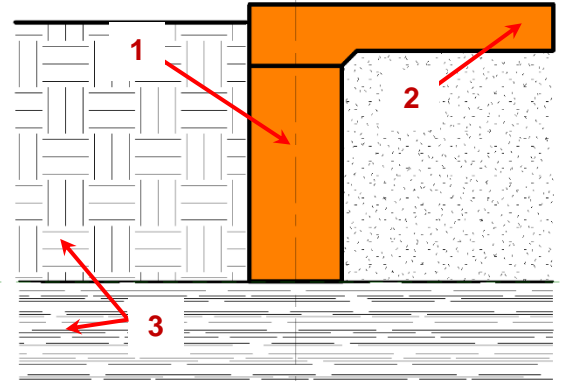
100	See <a href="#">A10</a>	
200	<p>See <a href="#">A10</a></p> <p><i>Image Notes:</i></p> <ul style="list-style-type: none"> <li>• <i>Generic beam geometry is shown.</i></li> <li>• <i>Geotechnical regions are shown for context and not required to be modeled as part of this element at this LOD.</i></li> </ul>	 <p>7 A1020.80-LOD-200 Grade Beams</p>
300	<p>See <a href="#">A1010</a></p> <p><i>Image Notes:</i></p> <ol style="list-style-type: none"> <li>1) <i>Grade Beam</i></li> <li>2) <i>See slab on grade (<a href="#">A4010</a>, <a href="#">A4020</a>) for related conditions at this LOD.</i></li> <li>1) <i>Geotechnical regions are shown for context and not required to be modeled as part of this element at this LOD.</i></li> </ol>	 <p>8 A1020.80-LOD-300 Grade Beams</p>

# Unifomat Omniclass

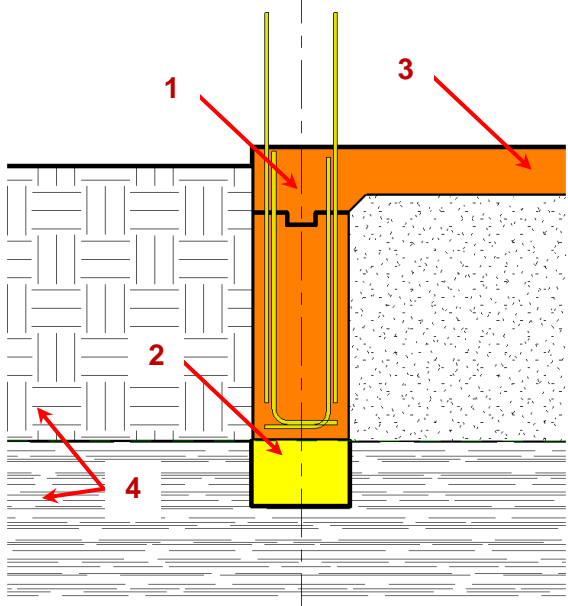
<p>350</p>	<p>Element modeling to include:</p> <ul style="list-style-type: none"> <li>• Water stops</li> <li>• Pour joints and sequences required to identify reinforcing lap splice, scheduling, etc.</li> <li>• Chamfer</li> </ul> <p><i>Image Notes:</i></p> <ul style="list-style-type: none"> <li>• <i>Grade beam sizes are modeled with interfaces to other systems such as but not limited to slab turn downs, key-ways between concrete pours, construction joints and reinforcing dowels into adjacent pours.</i></li> <li>• <i>Interface elements such as void boxes or critical bearing zones are modeled where applicable.</i></li> <li>• <i>See slab on grade ((A4010, A4020) for related conditions at this LOD.</i></li> <li>• <i>Geotechnical regions are shown for context and not required to be modeled as part of this element at this LOD.</i></li> </ul>	 <p>9 A1020.80-LOD-350 Grade Beams</p>
<p>400</p>	<p>Element modeling to include:</p> <ul style="list-style-type: none"> <li>• Detailed post-tensioned components</li> <li>• Rebar including hooks and lap splices</li> <li>• Dowels</li> <li>• Waterproofing</li> </ul>	

## A20 21-01 20 Subgrade Enclosures

Associated Masterformat Sections: 01 82 16

<p>100</p>	<p>Solid mass model representing overall building volume; or, schematic wall elements that are not distinguishable by type or material.</p> <p>Assembly depth/thickness and locations still flexible.</p>	
<p>200</p>	<p>Element modeling to include:</p> <ul style="list-style-type: none"> <li>• Approximate size and shape of the subgrade enclosure element.</li> <li>• Structural building grids for local project coordinate system are defined in model and coordinated with global civil coordinate system (State Plane Coordinate System, etc).</li> </ul> <p>Suggested Baseline Attributes</p> <p>1) Member Type</p>	



## Unifomat Omniclass

### A2010 21-01 20 10 Walls for Subgrade Enclosures

*Includes: Perimeter walls enclosing building space below grade. Includes formwork, reinforcing, concrete and masonry. Includes Subgrade Enclosure Wall Supplementary Components as appropriate. May Include: Related Activities: Excavation, dewatering, excavation support systems, backfill and compaction, and soil treatment.*

Associated Masterformat Sections: 01 82 16

100	See <a href="#">A20</a>	
200	See <a href="#">A20</a>	
300	<p>Element modeling to include:</p> <ul style="list-style-type: none"> <li>• Overall size and geometry of the subgrade element</li> <li>• Sloping surfaces</li> <li>• External dimensions of the element</li> <li>• Major openings such as large mechanical elements modeled to nominal dimensions.</li> </ul>	
350	<p>Element modeling to include:</p> <ul style="list-style-type: none"> <li>• Chamfers</li> <li>• All penetrations modeled to rough opening dimensions.</li> <li>• Pour joints</li> <li>• Rebar and any embedded elements modeled at congested areas where specified by project BXP which is typically within a set distance from the area of congestion.</li> <li>• Any permanent shoring or forming structures such as void boxes</li> <li>• insulation</li> <li>• Expansion joints</li> <li>• Moisture retarder</li> <li>• Exposed embeds or reinforcement such as lintels</li> <li>• Penetrations detailed and modeled</li> <li>• Expansion joints</li> </ul>	
400	<p>Element modeling to include:</p> <ul style="list-style-type: none"> <li>• Rebar including hooks and lap splices</li> <li>• Dowels</li> <li>• Coursing for unit masonry defined</li> <li>• Waterproofing</li> </ul>	

A2010.10	21-01 20 10 10	Subgrade Enclosure Wall Construction	TBD
A2010.20	21-01 20 10 20	Subgrade Enclosure Wall Interior Skin	TBD
A2010.90	21-01 20 10 90 TBD	Subgrade Enclosure Wall Supplementary Components	

## Uniformat Omniclass

### A40 21-01 40 Slabs-on-Grade

Associated Masterformat Sections: 01 82 00

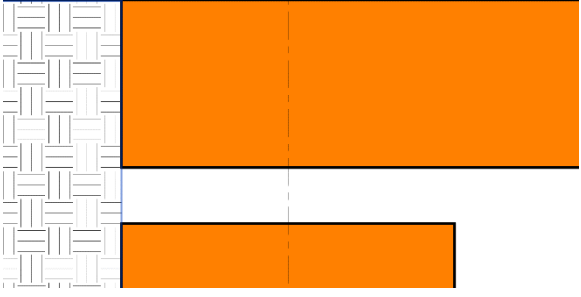
100	Assumptions for slabs are included in other modeled elements such as a volumetric mass or architectural floor element that contains a layer for assumed structural framing depth.	
200	<p>Element modeling to include</p> <ul style="list-style-type: none"> <li>• Generic slab with approximate thickness.</li> <li>• Structural building grids for local project coordinate system are defined in model and coordinated with global civil coordinate system (State Plane Coordinate System, etc.)</li> </ul>	 <p>10 A40-LOD-200 Slabs-on-Grade</p>

### A4010 21-01 40 10 Standard Slabs-on-Grade

*Includes: Slab construction supported continuously by earth or compacted fill. Includes fine grading, subbase layer, mud slab, insulation, vapor retarder, waterproofing, formwork, expansion joints, control joints, reinforcement, concrete, and finishing includes: Slabs-On-Grade Supplementary Components as appropriate. May Include: Related Activities: Excavation, dewatering, excavation support systems, backfill and compaction, and soil treatment.*

Associated Masterformat Sections: 03 30 00

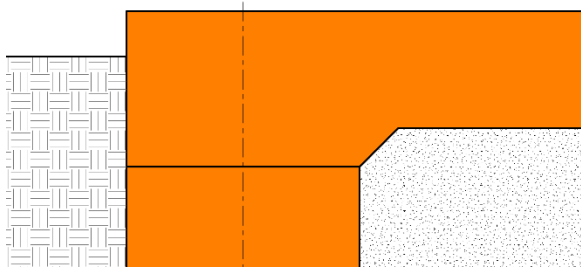
100	See <a href="#">A40</a>	
200	See <a href="#">A40</a>	
300	<p>Element modeling to include:</p> <ul style="list-style-type: none"> <li>• Overall size, thickness and geometry of the slab</li> <li>• Major openings such as large mechanical elements modeled to nominal dimensions.</li> <li>• Slab depressions</li> <li>• Edge turn downs</li> <li>• Material strength</li> <li>• Surfaces modeled to actual slopes</li> </ul>	 <p>11 A4010-LOD-300 Standard Slabs-on-Grade</p>

## Unifomat Omniclass

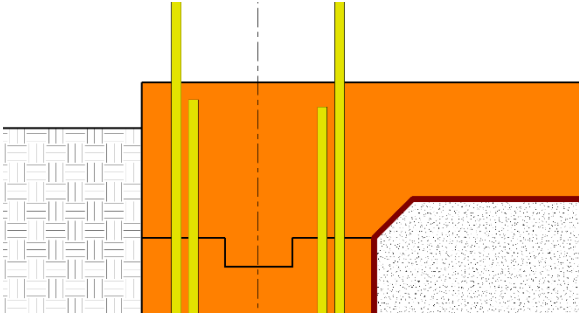
<p>350</p>	<p>Element modeling to include:</p> <ul style="list-style-type: none"> <li>• All penetrations modeled to rough opening dimensions.</li> <li>• Pour joints</li> <li>• Control joints</li> <li>• Expansion joints</li> <li>• Water stops</li> <li>• Rebar and any embedded elements modeled at congested areas where specified by project BIMXP which is typically within a set distance from the area of congestion.</li> <li>• Void boxes</li> <li>• Anchor rods</li> <li>• Dowels</li> <li>• Post-tension profile and strands if required by the BXP.</li> </ul>	 <p>12 A4010-LOD-350 Standard Slabs-on-Grade</p>
<p>400</p>	<p>Element modeling to include:</p> <ul style="list-style-type: none"> <li>• Fully modeled rebar</li> <li>• Actual slab dimensions and profiles with fully modeled rebar</li> <li>• Post tensioning components</li> <li>• All joints</li> <li>• Water proofing</li> <li>• Finish</li> </ul>	

### A4020 21-01 40 20 Structural Slabs-on-Grade

*Includes: Self-supporting slab construction not supported continuously by earth or compacted fill. Includes formwork, accessories, reinforcement, concrete, and finishing. Includes Slabs-On-Grade Supplementary Components as appropriate. May Include: Related Activities: Excavation, dewatering, excavation support systems, backfill and compaction, and soil treatment.*

Associated Masterformat Sections: 03 30 00

<p>100</p>	<p>See <a href="#">A40</a></p>	
<p>200</p>	<p>See <a href="#">A40</a></p>	

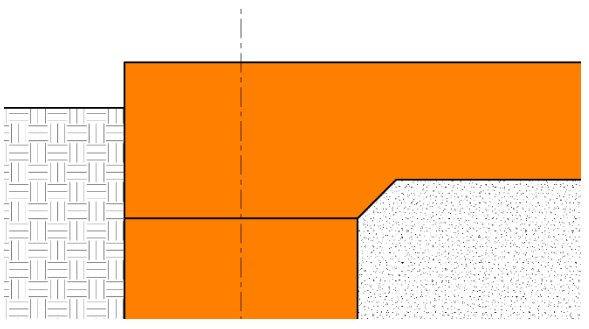
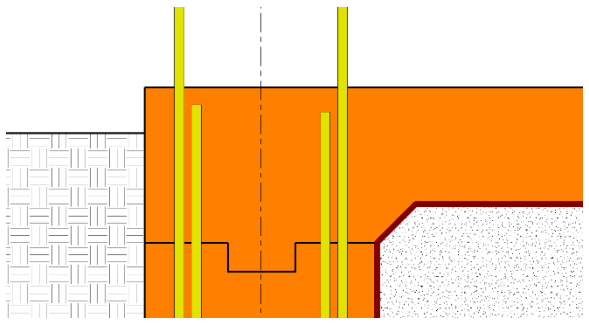

# Unifomat Omniclass

<p>300</p>	<p>Element modeling to include:</p> <ul style="list-style-type: none"> <li>• Overall size, thickness and geometry of the slab-on-grade</li> <li>• Major openings such as large mechanical elements modeled to nominal dimensions.</li> <li>• Slab depressions</li> <li>• Edge turn downs</li> <li>• All sloping surfaces included in model element with exception of elements affected by manufacturer selection which are not known at this LOD. Such conditions could include floor geometry differences where different <u>specified</u> manufacturers will not be known until the <u>actual</u> system is selected.</li> </ul>	 <p>13 A4020-LOD-300 Structural Slabs-on-Grade</p>
<p>350</p>	<p>Element modeling to include:</p> <ul style="list-style-type: none"> <li>• All penetrations modeled to rough opening dimensions.</li> <li>• Pour joints</li> <li>• Control joints</li> <li>• Expansion joints</li> <li>• Water Stops</li> <li>• Rebar and any embedded elements modeled at congested areas where specified by project BXP which is typically within a set distance from the area of congestion.</li> <li>• Void boxes</li> <li>• Anchor rods</li> <li>• Moisture retarder</li> <li>• Dowels</li> <li>• Post-tension profile and strands modeled if required by the BXP</li> </ul>	 <p>14 A4020-LOD-350 Structural Slabs-on-Grade</p>
<p>400</p>	<p>Element modeling to include:</p> <ul style="list-style-type: none"> <li>• Fully modeled rebar</li> <li>• Actual slab dimensions and profiles with fully modeled rebar</li> <li>• Post tensioning components</li> <li>• All joints</li> <li>• Water proofing</li> <li>• Finish</li> </ul>	

A4030	21-01-40-30	Slab Trenches	TBD
A4040	21-01-40-40	Pits and Bases	TBD
A4090	21-01-40-90	Slab-On-Grade Supplementary Components	TBD

Unifomat	Omniclass		
A60	21-01-60	Water and Gas Mitigation	TBD
A6010	21-01-60-10	Building Subdrainage	TBD
A6020	21-01-60-20	Off-Gassing Mitigation	TBD
A90	21-01-90	Substructure Related Activities	TBD
A9010	21-01-90-10	Substructure Excavation	TBD
A9020	21-01-90-20	Construction Dewatering	TBD
A9030	21-01-90-30	Excavation Support	TBD
A9040	21-01-90-40	Soil Treatment	TBD

## Unifomat Omniclass

### **B** 21-02 00 00 SHELL

Associated Masterformat Sections: 01 83 00

### **B10** 21-02 10 Superstructure

Associated Masterformat Sections: 01 83 13

100	Assumptions for structural framing are included in other modeled elements such as an architectural floor element that contains a layer for assumed structural framing depth or schematic structural elements that are not distinguishable by type or material.  Assembly depth/thickness or component size and locations still flexible.	
-----	--	--

### **B1010** 21-02 10 10 Floor Construction

Associated Masterformat Sections: 01 83 13

100	See <a href="#">B10</a>	
200	Model elements to include: <ul style="list-style-type: none"> <li>• Floor with approximate dimensions</li> <li>• Approximate supporting framing members</li> <li>• Structural grids defined accurately</li> </ul>	

### **B1010.10** 21-02 10 10 10 Floor Structural Frame

*Includes: Structural elements required for support of floor construction within basements and above grade. Includes columns, girders, beams, trusses, joists. Includes cast-in-place concrete, precast concrete, unit masonry, metal framed, and wood framed systems. Includes framed and sleeved openings for services. Includes Floor Construction Supplementary Components as appropriate.*

Specific structural systems within this section are listed as follows:

- Concrete [B1010.10.10](#)
- Precast Structural Inverted T Beam [B1010.10.11](#)
- Precast Structural Column [B1010.10.12](#)
- Masonry [B1010.10.20](#)
- Steel Framing Columns [B1010.10.30](#)
- Steel Framing Beams [B1010.10.40](#)
- Steel Framing Bracing Rods [B1010.10.50](#)
- Steel Joists [B1010.10.60](#)
- Cold-Formed Metal Framing [B1010.10.70](#)
- Wood Floor Trusses [B1010.10.80](#)

Associated Masterformat Sections: 03 30 00 / 03 40 00 / 04 20 00 / 05 10 00 / 05 20 00  
05 21 23 / 05 42 00 / 05 44 00 / 06 11 00 / 06 13 00 / 06 13 26 / 06 17 33 / 06 17 36  
06 17 53 / 06 18 13 / 06 18 16 / 06 50 00

### **B1010.10.10** 21-02 10 10 10 10 Floor Structural Frame (Concrete)

Associated Masterformat Sections: 03 30 00 / 03 40 00

[Back to TOC](#)



Copyright © 2017 by BIMForum. All rights reserved

This document is copyrighted under a [Creative Commons Attribution-NonCommercial-NoDerivatives 4.0 International License](#).

## Unifomat Omniclass

100	See <a href="#">B10</a>	
200	Element modeling to include: <ul style="list-style-type: none"> <li>Type of structural concrete system</li> <li>Approximate geometry (e.g. depth) of structural elements</li> </ul>	
300	Element modeling to include: <ol style="list-style-type: none"> <li>Composite model assembly by type with overall thickness of structural frame</li> </ol> <ul style="list-style-type: none"> <li>Specific sizes and locations of main concrete structural members modeled per defined structural grid with correct orientation</li> <li>Concrete defined per spec (strength, air entrainment, aggregate size, etc.)</li> <li>All sloping surfaces included in model element with exception of elements affected by manufacturer selection</li> </ul>	
350	Element modeling to include: <ul style="list-style-type: none"> <li>Reinforcing Post-tension profiles and strand locations</li> <li>Reinforcement called out, modeled if required by the BXP, typically only in congested areas</li> <li>Pour joints and sequences to help identify reinforcing lap splice locations, scheduling, etc.</li> <li>Expansion Joints</li> <li>Embeds and anchor rods</li> <li>Post-tension profile and strands modeled if required by the BXP</li> <li>Penetrations for items such as MEP</li> <li>Any permanent forming or shoring components</li> <li>Shear reinforcing and stud rails</li> <li>Critical structural zones for coordination, including but not limited to zones that cannot be penetrated, cut, or damaged</li> <li>Chamfer</li> </ul>	
400	Element modeling to include: <ul style="list-style-type: none"> <li>All reinforcement including post tension elements detailed and modeled camber, etc.</li> </ul>	

### B1010.10.11 21-02 10 10 10 11 Precast Structural Inverted T Beam (Concrete)

*Includes: Structural elements required for support of floor construction within basements and above grade. Includes columns, girders, beams, trusses, joists. Includes cast-in-place concrete, precast concrete, unit masonry, metal framed, and wood framed systems. Includes framed and sleeved openings for services. Includes Floor Construction Supplementary Components as appropriate.*

Associated Masterformat Sections: 03 30 00 / 03 40 00 / 04 20 00 / 05 10 00 / 05 20 00  
05 21 23 / 05 42 00 / 05 44 00 / 06 11 00 / 06 13 00 / 06 13 26 / 06 17 33 / 06 17 36  
06 17 53 / 06 18 13 / 06 18 16 / 06 50 00

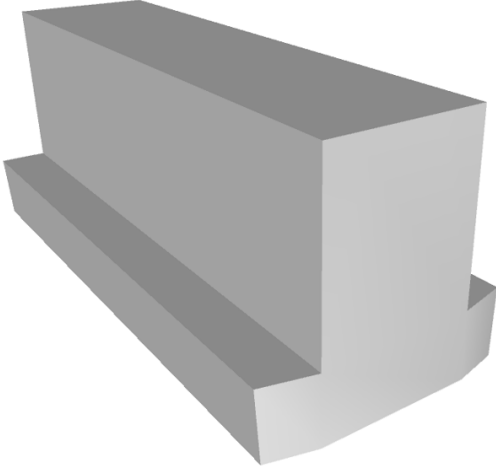
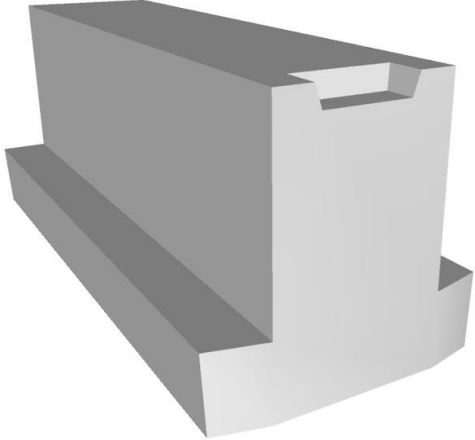

# Unifomat Omniclass

100	See <a href="#">B10</a>	
200	<p>Element modeling to include:</p> <ul style="list-style-type: none"> <li>• Type of structural concrete system</li> <li>• Approximate geometry (e.g. depth) of structural elements</li> </ul>	 <p><i>15 B1010.10-LOD 200 Precast Structural Inverted T Beam (Concrete)</i></p>
300	<p>Element modeling to include:</p> <ul style="list-style-type: none"> <li>• Specific sizes and locations of main concrete structural members modeled per defined structural grid with correct orientation</li> <li>• All sloping surfaces included in model element with exception of elements affected by manufacturer selection</li> </ul>	 <p><i>16 B1010.10-LOD 300 Precast Structural Inverted T Beam (Concrete)</i></p>

# Unifomat Omniclass

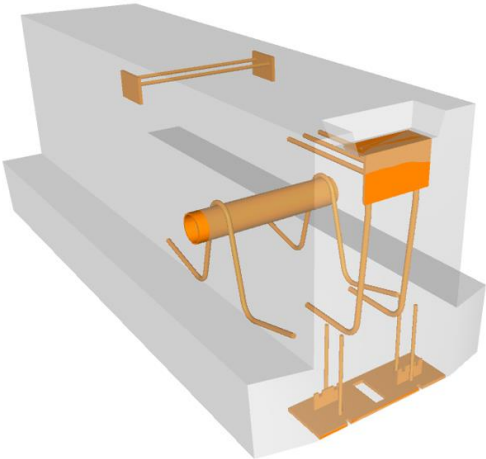
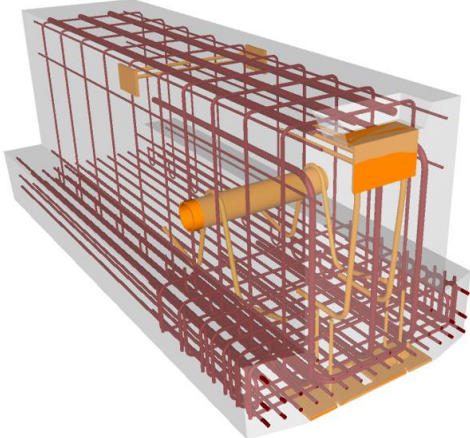
<p>350</p>	<p>Element modeling to include:</p> <ul style="list-style-type: none"> <li>• Reinforcing Post-tension profiles and strand locations</li> <li>• Reinforcement called out, modeled if required by the BXP, typically only in congested areas</li> <li>• Chamfer</li> <li>• Pour joints and sequences to help identify reinforcing lap splice locations, scheduling, etc.</li> <li>• Lifting devices</li> <li>• Expansion Joints</li> <li>• Embeds and anchor rods</li> <li>• Post-tension profile and strands modeled if required by the BXP</li> <li>• Penetrations for items such as MEP</li> <li>• Any permanent forming or shoring components</li> </ul>	 <p><i>17 B1010.10-LOD 350 Precast Structural Inverted T Beam (Concrete)</i></p>
<p>400</p>	<p>Element modeling to include:</p> <ul style="list-style-type: none"> <li>• All reinforcement including post tension elements detailed and modeled</li> <li>• Finishes</li> </ul>	 <p><i>18 B1010.10-LOD 400 Precast Structural Inverted T Beam (Concrete)</i></p>

## Uniformat Omniclass

### B1010.10.12 21-02 10 10 10 12 Precast Structural Column (Concrete)

*Includes: Structural elements required for support of floor construction within basements and above grade. Includes columns, girders, beams, trusses, joists. Includes cast-in-place concrete, precast concrete, unit masonry, metal framed, and wood framed systems. Includes framed and sleeved openings for services. Includes Floor Construction Supplementary Components as appropriate.*

Associated Masterformat Sections: 03 30 00 / 03 40 00 / 04 20 00 / 05 10 00 / 05 20 00  
05 21 23 / 05 42 00 / 05 44 00 / 06 11 00 / 06 13 00 / 06 13 26 / 06 17 33 / 06 17 36  
06 17 53 / 06 18 13 / 06 18 16 / 06 50 00

100	See <a href="#">B10</a>	
200	<p>Element modeling to include:</p> <ul style="list-style-type: none"> <li>• Type of structural concrete system</li> <li>• Approximate geometry (e.g. depth) of structural elements</li> </ul>	 <p>19 B1010.10- LOD 200 Precast Structural Column (Concrete)</p>

# Uniformat Omniclass

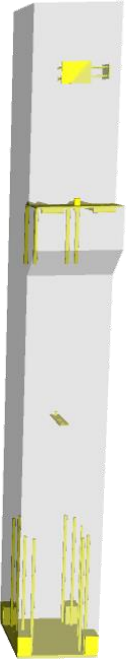
<p>300</p>	<p>Element modeling to include:</p> <ul style="list-style-type: none"> <li>• Specific sizes and locations of main concrete structural members modeled per defined structural grid with correct orientation</li> <li>• All sloping surfaces included in model element with exception of elements affected by manufacturer selection</li> </ul>	 <p><i>20 B1010.10 - LOD 300 Precast Structural Column (Concrete)</i></p>
<p>350</p>	<p>Element modeling to include:</p> <ul style="list-style-type: none"> <li>• Reinforcing Post-tension profiles and strand locations</li> <li>• Reinforcement called out, modeled if required by the BXP, typically only in congested areas</li> <li>• Chamfer</li> <li>• Pour joints and sequences to help identify reinforcing lap splice locations, scheduling, etc.</li> <li>• Expansion Joints</li> <li>• Lifting devices</li> <li>• Embeds and anchor rods</li> <li>• Post-tension profile and strands modeled if required by the BXP</li> <li>• Penetrations for items such as MEP</li> <li>• Any permanent forming or shoring components</li> </ul>	 <p><i>21 B1010.10 - LOD 350 Precast Structural Column (Concrete)</i></p>



# Uniformat Omniclass

400	<p>Element modeling to include:</p> <ul style="list-style-type: none"> <li>All reinforcement including post tension elements detailed and modeled</li> <li>Finishes</li> </ul>	 <p>22 B1010.10 - LOD 400 Precast Structural Column (Concrete)</p>
-----	--	---

## B1010.10.20 21-02 10 10 10 20 Floor Structural Frame (Masonry)

Associated Masterformat Sections: 04 20 00

100	See <a href="#">B10</a>	
200	<p>Element modeling to include:</p> <ul style="list-style-type: none"> <li>Type of structural masonry system</li> </ul>	
300	<p>Element modeling to include:</p> <ul style="list-style-type: none"> <li>Specific sizes of main structural elements modeled per defined structural grid with correct dimensions</li> <li>Rough openings with reinforcement and lintels called out</li> <li>Penetrations for items such as MEP</li> </ul>	
350	<p>Element modeling to include:</p> <ul style="list-style-type: none"> <li>Actual location and shape of structural masonry element</li> <li>All exposed embeds or reinforcement such as lintels</li> <li>All penetrations modeled to rough opening dimensions</li> <li>Expansion joints</li> <li>Grouted cell locations</li> </ul>	





# Unifomat Omniclass

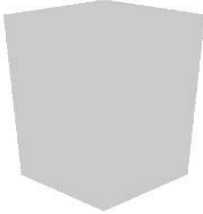
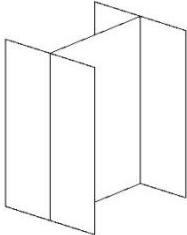

400	Element modeling to include: <ul style="list-style-type: none"> <li>• Waterproofing</li> <li>• Coursing</li> <li>• Reinforcing</li> <li>Grout</li> </ul>	
-----	--	--

B1010.10.30 21-02 10 10 10 30 Floor Structural Frame (Steel Framing Columns)

Associated Masterformat Sections: 05 10 00

100	Generic column element, See <a href="#">B10</a> .	 <i>23 B1010.10-LOD-100 Floor Structural Frame (Steel Framing Columns)</i>
200	See <a href="#">B1010</a>	 <i>24 B1010.10-LOD-200 Floor Structural Frame (Steel Framing Columns)</i>
300	Element modeling to include: <ul style="list-style-type: none"> <li>• Specific sizes of main vertical structural members modeled per defined structural grid with correct location and orientation</li> </ul>	 <i>25 B1010.10-LOD-300 Floor Structural Frame (Steel Framing Columns)</i>

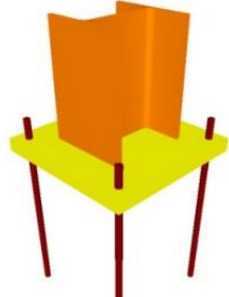
## Unifomat Omniclass

<p>350</p>	<p>Element modeling to include:</p> <ul style="list-style-type: none"> <li>• Actual elevations and location of member connections</li> <li>• Main elements of typical connections applied to all structural steel connections such as base plates, gusset plates, anchor rods, etc.</li> <li>• Any miscellaneous steel members with correct size, shape, orientation, and material.</li> <li>• Any steel structure reinforcement such as web stiffeners, sleeve penetrations, etc.</li> </ul>	 <p><i>26 B1010.10-LOD-350 Floor Structural Frame (Steel Framing Columns)</i></p>
<p>400</p>	<p>Element modeling to include:</p> <ul style="list-style-type: none"> <li>• Welds</li> <li>• Coping of members</li> <li>• Cap pates</li> <li>• Washers, nuts, etc.</li> <li>• All assembly elements</li> </ul>	 <p><i>27 B1010.10-LOD-400 Floor Structural Frame (Steel Framing Columns)</i></p>

# Unifomat Omniclass

## B1010.10.40 21-02 10 10 10 40 Floor Structural Frame (Steel Framing Beams)

Associated Masterformat Sections: 05 10 00 / 05 20 00 / 05 21 23

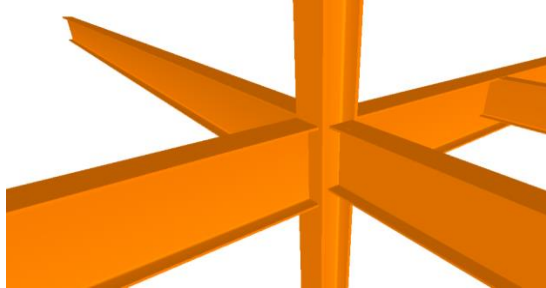
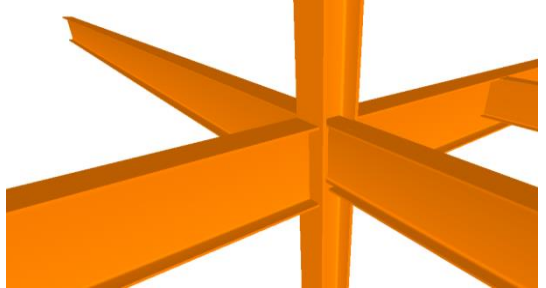
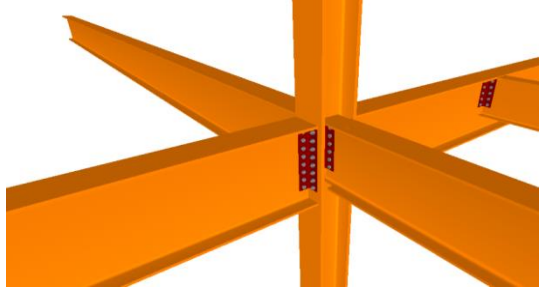
100	See <a href="#">B10</a>	
200	See <a href="#">B1010</a>	
300	<p>Element modeling to include:</p> <ul style="list-style-type: none"> <li>• Specific sizes of main horizontal structural members modeled per defined structural grid with correct orientation, slope and elevation</li> <li>•</li> </ul>	 <p><i>28 B1010.10-LOD-300 Floor Structural Frame (Steel Framing Beams)</i></p>
350	<p>Element modeling to include:</p> <ul style="list-style-type: none"> <li>• Actual elevations and location of member connections</li> <li>• Main elements of typical connections applied to all structural steel connections such as base plates, gusset plates, anchor rods, etc.</li> <li>• Any miscellaneous steel members with correct size, shape, orientation and material</li> <li>• Any steel structure reinforcement such as web stiffeners, sleeve penetrations, etc.</li> </ul>	 <p><i>29 B1010.10-LOD-350 Floor Structural Frame (Steel Framing Beams)</i></p>
400	<p>Element modeling to include:</p> <ul style="list-style-type: none"> <li>• Welds</li> <li>• Coping of members</li> <li>• Bent plates, cap plates, etc.</li> <li>• Bolts, washers, nuts, etc.</li> <li>• All assembly elements</li> </ul>	 <p><i>30 B1010.10-LOD-400 Floor Structural Frame (Steel Framing Beams)</i></p>

# Unifomat Omniclass

B1010.10.50 21-02 10 10 10 50 Floor Structural Frame (Steel Framing Bracing Rods)

Associated Masterformat Sections: 05 10 00

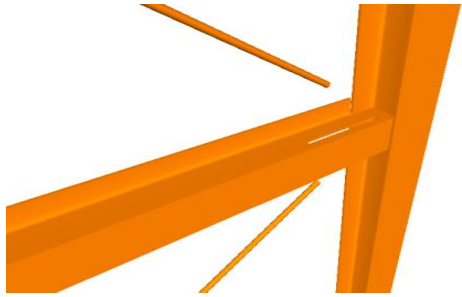
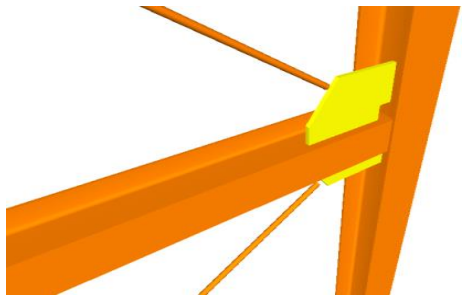
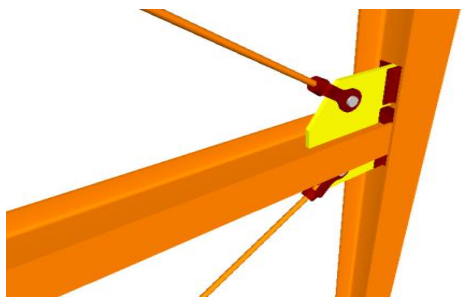
100	See <a href="#">B10</a>	
200	See <a href="#">B1010</a>	
300	<p>Element modeling to include:</p> <ul style="list-style-type: none"> <li>• Specific sizes of main structural braces modeled per defined structural grid</li> </ul>	 <p>31 B1010.100-LOD-300 Floor Structural Frame (Steel Framing Bracing Rods)</p>
350	<p>Element modeling to include:</p> <ul style="list-style-type: none"> <li>• Connection details</li> <li>• Actual elevations and location of member connections</li> <li>• Main elements of typical connections applied to all structural steel connections such as base plates, gusset plates, anchor rods, etc.</li> <li>• Any miscellaneous steel members with correct size, shape, orientation and material</li> </ul>	 <p>32 B1010.100-LOD-350 Floor Structural Frame (Steel Framing Bracing Rods)</p>
400	<p>Element modeling to include:</p> <ul style="list-style-type: none"> <li>• Welds</li> <li>• Clevis</li> <li>• Bolts, washers, nuts, etc.</li> <li>• All assembly elements</li> </ul>	 <p>33 B1010.100-LOD-400 Floor Structural Frame (Steel Framing Bracing Rods)</p>

# Unifomat Omniclass

## B1010.10.60 21-02 10 10 10 60 Floor Structural Frame (Steel Joists)

Associated Masterformat Sections: 05 10 00 / 05 20 00 / 05 21 23

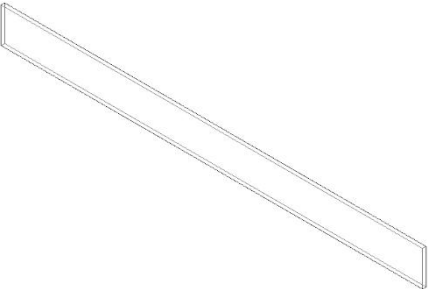
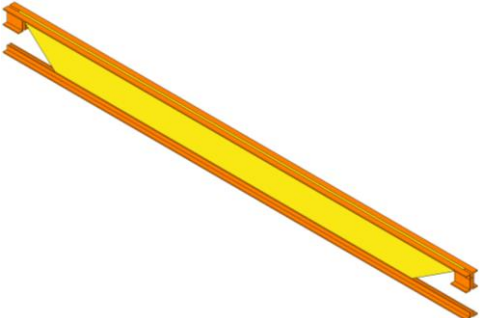
100	See <a href="#">B10</a>	
200	<p>Element modeling to include:</p> <ul style="list-style-type: none"> <li>• Approximate depth</li> </ul>	 <p><i>34 B1010.10-LOD-200 Floor Structural Frame (Steel Joists)</i></p>
300	<p>Element modeling to include:</p> <ul style="list-style-type: none"> <li>• Joist size, depth, slope, and material</li> <li>• Spacing and end elevations</li> <li>• Joist seat depth</li> <li>•</li> </ul>	 <p><i>35 B1010.10-LOD-300 Floor Structural Frame (Steel Joists)</i></p>

# Unifomat Omniclass

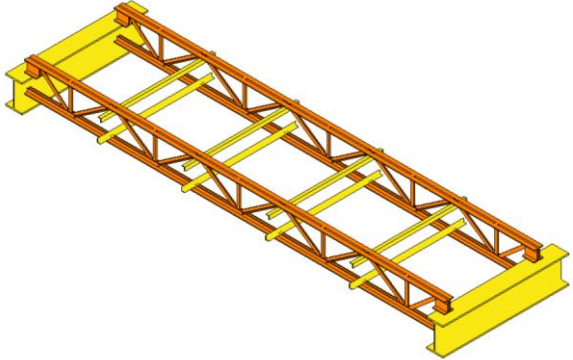
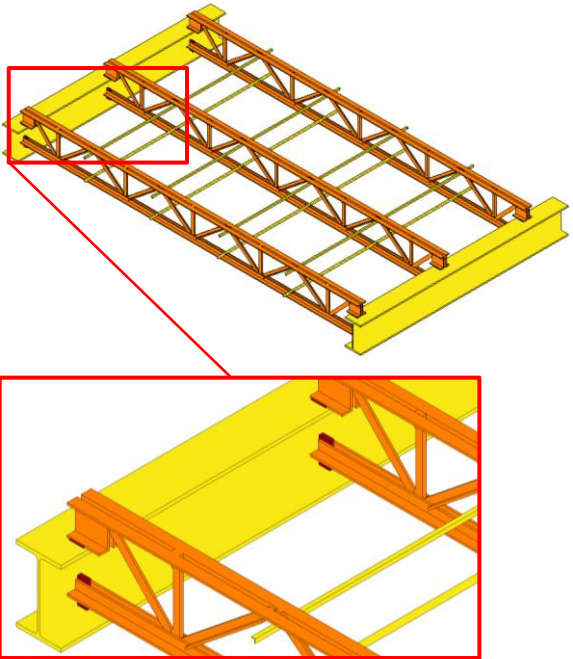
<p>350</p>	<p>Element modeling to include, information needed for cross trade collaboration such as:</p> <ul style="list-style-type: none"> <li>• Actual final joist profile locations with accurate panel points</li> <li>• Joist bridging and lateral braces.</li> <li>• Fire protection coating</li> <li>• Any miscellaneous steel pertaining to the joist</li> <li>• Joist seat width</li> <li>• Erection details for installation</li> <li>• Chord and web member section profiles are defined</li> <li>• Joist layout in coordination with metal deck fasteners would be confirmed</li> <li>• Non-standard joist seat depths and/or sloping joist seat</li> </ul>	 <p>36 B1010.10-LOD-350 Floor Structural Frame (Steel Joists)</p>
<p>400</p>	<p>Element modeling to include:</p> <ul style="list-style-type: none"> <li>• Welds</li> <li>• Connection plates</li> <li>• Member fabrication part number</li> <li>• Quantity</li> <li>• Spacing</li> <li>• Anchorage</li> <li>• Material required for proper installation</li> <li>• Mark identification that correlates with bill of material</li> </ul> <p>Type of shop paint if required</p>	 <p>37 B1010.10-LOD-400 Floor Structural Frame (Steel Joists)</p>

B1010.10.70 21-02 10 10 10 70 Floor Structural Framing (Cold Formed Metal Framing)

Associated Masterformat Sections: 05 10 00 / 05 42 00 / 05 44 00

## Unifomat Omniclass

100	See <a href="#">B10</a>	
200	Element modeling to include: <ul style="list-style-type: none"> <li>• Rough architectural masses</li> <li>• Approximate member depth</li> <li>• Desired member spacing</li> </ul>	
300	Element modeling to include: <ul style="list-style-type: none"> <li>• floor element with design-specified locations and geometries</li> </ul>	
350	Element modeling to include: <ul style="list-style-type: none"> <li>• Members modeled at any interface with wall edges (top, bottom, sides) or opening through wall</li> <li>• Bridging or straps</li> </ul>	
400	Element modeling to include: <ul style="list-style-type: none"> <li>• Welds</li> <li>• Connections</li> <li>• Member fabrication part number</li> <li>• Any part required for complete installation</li> </ul>	

### B1010.10 21-02 10 10 10 Floor Structural Frame (Masonry Framing)

*Includes: Structural elements required for support of floor construction within basements and above grade. Includes columns, girders, beams, trusses, joists. Includes cast-in-place concrete, precast concrete, unit masonry, metal framed, and wood framed systems. Includes framed and sleeved openings for services. Includes Floor Construction Supplementary Components as appropriate.*

Associated Masterformat Sections: 04 20 00

100	See <a href="#">B10</a>	
-----	-------------------------	--

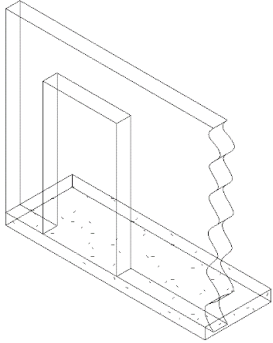
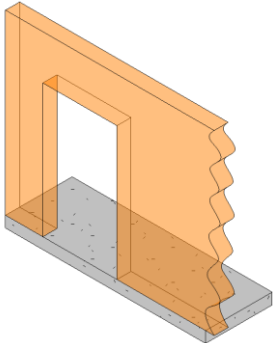
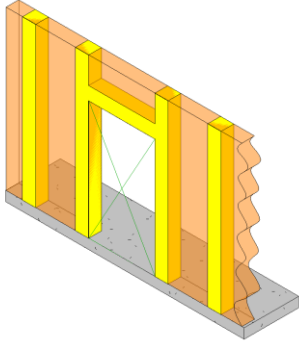

# Unifomat Omniclass

200	See B10	 <p><i>38 B1010.10-LOD-200 Floor Structural Frame (Masonry Framing)</i></p>
300	<p>Element modeling to include:</p> <ul style="list-style-type: none"> <li>• floor element with design-specified locations and geometries</li> </ul>	 <p><i>39 B1010.10-LOD-300 Floor Structural Frame (Masonry Framing)</i></p>
350	<p>Element modeling to include:</p> <ul style="list-style-type: none"> <li>• Members modeled at any interface with wall edges (top, bottom, sides) or opening through wall</li> <li>• Any regions that would impact coordination with other systems such as but not limited to: <ul style="list-style-type: none"> <li>○ Bond Beam &amp; Lintel Regions</li> <li>○ Reinforcing &amp; Embed Regions</li> <li>○ Jam Regions</li> <li>○ Any other grouted regions</li> </ul> </li> </ul>	 <p><i>40 B1010.10-LOD-350 Floor Structural Frame (Masonry Framing)</i></p>

# Uniformat Omniclass

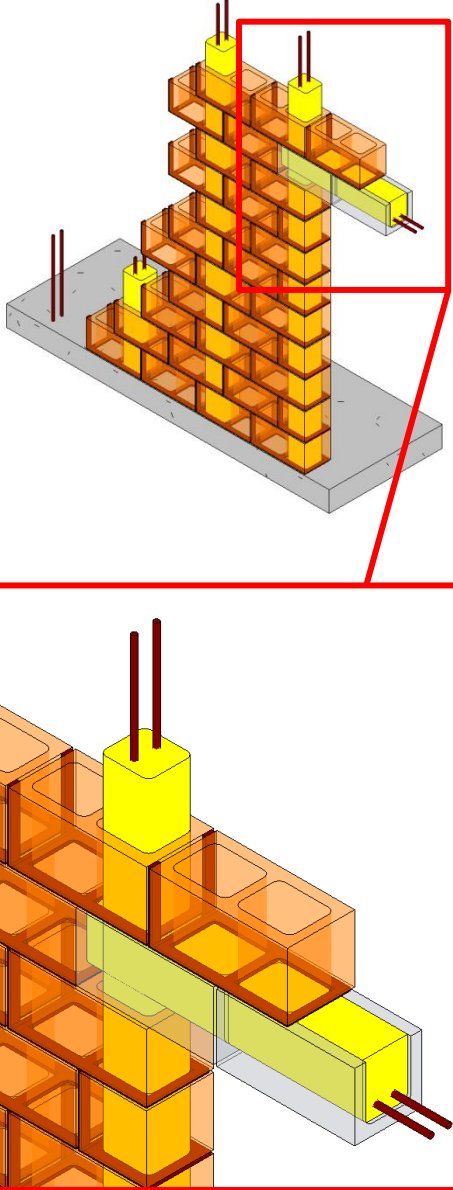
<p>400</p>	<p>Element modeling to include:</p> <ul style="list-style-type: none"> <li>• Reinforcing</li> <li>• Connections</li> <li>• Grouting Material</li> <li>• Jams</li> <li>• Bond Beams</li> <li>• Lintels</li> <li>• Member fabrication part number</li> <li>• Any part required for complete installation</li> </ul>	 <p>41 B1010.10-LOD-400 Floor Structural Frame (Masonry Framing)</p>
------------	---	--

B1010.10.80 21-02 10 10 10 80 Floor Structural Frame (Wood Floor Trusses)

Associated Masterformat Sections: 06 11 00 / 06 13 26 / 06 17 53

100	See <a href="#">B10</a>	
-----	-------------------------	--

[Back to TOC](#)



Copyright © 2017 by BIMForum. All rights reserved  
This document is copyrighted under a [Creative Commons Attribution-NonCommercial-NoDerivatives 4.0 International License](#).

# Uniformat Omniclass

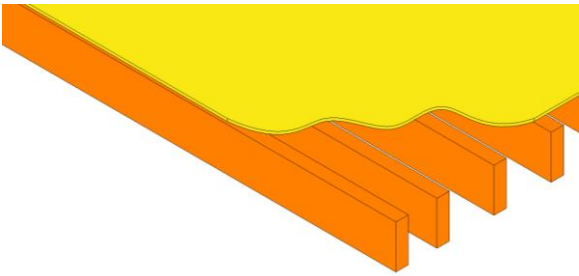
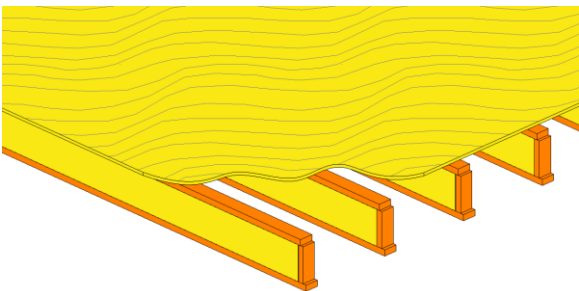
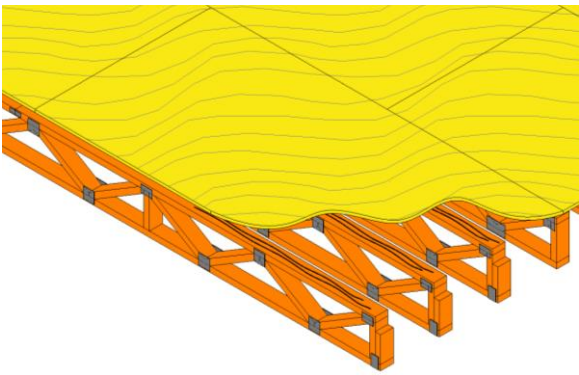
<p>200</p>	<p>Element modeling to include:</p> <ul style="list-style-type: none"> <li>• Top chord or bottom chord bearing</li> <li>• Truss orientation</li> <li>• Approximate depth</li> <li>• Approximate width</li> <li>• Truss orientation</li> <li>• Approximate centerline location of individual trusses</li> </ul>	 <p><i>42 B1010.10-LOD-200 Floor Structural Frame (Wood Floor Trusses)</i></p>
<p>300</p>	<p>Element modeling to include:</p> <ul style="list-style-type: none"> <li>• Truss size, depth, and material with sloping geometry</li> <li>• Spacing and end elevations</li> <li>• Support locations</li> </ul>	 <p><i>43 B1010.10-LOD-300 Floor Structural Frame (Wood Floor Trusses)</i></p>
<p>350</p>	<p>Element modeling to include:</p> <ul style="list-style-type: none"> <li>• Actual final truss profile with accurate panel points</li> <li>• Bridging and lateral braces</li> <li>• Fire protection coating</li> <li>• Any miscellaneous framing pertaining the truss</li> <li>• Erection details for installation</li> <li>• Chord and web member section profiles are accurately defined</li> <li>• Truss layout in coordination with deck fasteners would be confirmed</li> <li>• Hold down locations for large bolts.</li> </ul>	 <p><i>44 B1010.10-LOD-350 Floor Structural Frame (Wood Floor Trusses)</i></p>

# Unifomat Omniclass

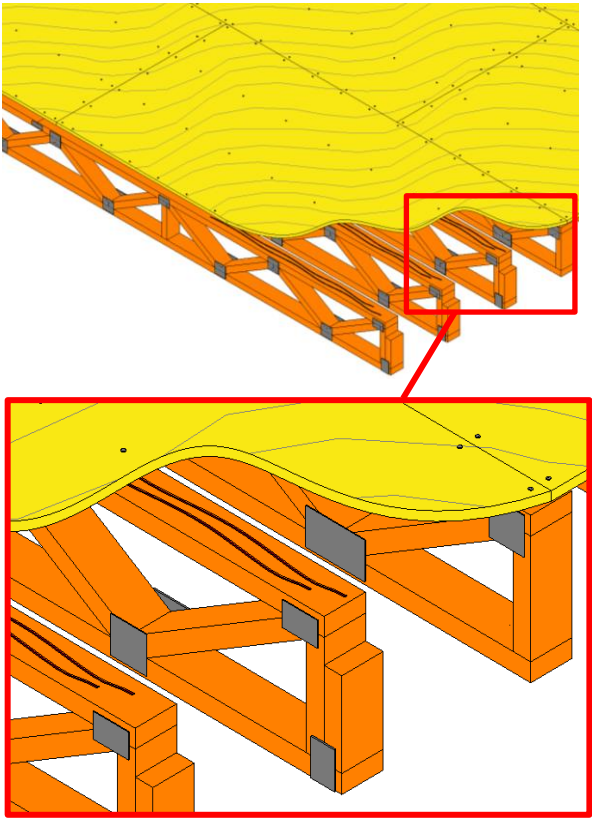
<p>400</p>	<p>Element modeling to include:</p> <ul style="list-style-type: none"> <li>• Fasteners</li> <li>• Sealant</li> <li>• Truss plates and connection material</li> <li>• Nails and fasteners</li> <li>• Truss plates.</li> <li>• Deck patterns and joints</li> </ul>	 <p>45 B1010.10-LOD-400 Floor Structural Frame (Wood Floor Trusses)</p>
------------	--	--

## B1010.20 21-02 10 10 20 Floor Decks, Slabs, and Toppings

*Includes: Structural slab, deck, and sheathing floor construction at intermediate floors of basement construction and above grade. Includes cast-in-place concrete, precast concrete, cementitious decks and toppings, metal decking, wood sheathing, and wood decking. Includes framed and sleeved penetrations for services and housekeeping pads for equipment. Includes Floor Construction Supplementary Components as appropriate.*

Specific structural systems within this section are listed as follows:

- [Wood Floor Deck](#)
- [Metal Floor Deck](#)
- [Composite Floor Deck](#)
- [Concrete](#)

Associated Masterformat Sections: 03 30 00 / 03 40 00 / 03 50 00 / 05 30 00 / 05 34 00  
05 35 00 / 06 12 00 / 06 15 00 / 06 16 00 / 06 18 00 / 06 53 00 / 06 73 00

## B1010.20.10 21-02 10 10 20 10 Floor Decks, Slabs, and Toppings (Wood Floor Deck)

Associated Masterformat Sections: 06 12 00 / 06 15 00 / 06 16 00 / 06 18 00

## Unifomat Omniclass

100	See <a href="#">B10</a>	
200	See <a href="#">B10</a>	
300	Element modeling to include: <ul style="list-style-type: none"> <li>• Applicable slopes</li> <li>• Expected framing member profiles, spacing, and material</li> </ul>	
350	Element modeling to include: <ul style="list-style-type: none"> <li>• Deck edge location</li> <li>• Actual framing member and location per manufacture</li> <li>• All miscellaneous framing including braces, kickers, etc.</li> <li>• Deck openings modeled with support framing around openings</li> <li>• Point load locations</li> <li>• Actual opening locations and sizes defined</li> </ul>	
400	Element modeling to include: <ul style="list-style-type: none"> <li>• All framing accessory and fasteners modeled per expected installation</li> <li>• Waterproofing</li> </ul>	

### B1010.20.20 21-02 10 10 20 20 Floor Decks, Slabs, and Toppings (Metal Floor Deck)

Associated Masterformat Sections: 05 30 00 / 05 34 00 / 05 35 00

100	See <a href="#">B10</a>	
200	See <a href="#">B10</a>	
300	Element modeling to include: <ul style="list-style-type: none"> <li>• Deck thickness</li> <li>• Specific Framing member profiles, spacing, and material</li> <li>• Opening locations are prescriptively defined with notes for additional miscellaneous framing</li> <li>• Point load locations</li> </ul>	
350	Element modeling to include: <ul style="list-style-type: none"> <li>• Deck edge location</li> <li>• Deck splice and end lap locations</li> <li>• Actual deck profile and flute locations per manufacturer</li> <li>• All miscellaneous framing including braces, kickers, etc.</li> <li>• Deck openings modeled with support framing</li> </ul>	
400	Element modeling to include: <ul style="list-style-type: none"> <li>• All framing accessory and fasteners modeled per expected installation</li> <li>• Welds</li> <li>• Waterproofing</li> </ul>	

## Unifomat Omniclass

### B1010.20.30 21-02 10 10 20 30 Floor Decks, Slabs, and Toppings (Composite Floor Deck)

Associated Masterformat Sections: 06 73 00

100	See <a href="#">B10</a>	
200	See <a href="#">B10</a>	
300	<p>Element modeling to include:</p> <ul style="list-style-type: none"> <li>• Specific deck thickness</li> <li>• Specific Framing member profiles, spacing, material</li> <li>• Opening locations are prescriptively defined with notes for additional miscellaneous framing</li> </ul>	
350	<p>Element modeling to include:</p> <ul style="list-style-type: none"> <li>• Deck edge location</li> <li>• Actual deck profile and flute locations per manufacture</li> <li>• Deck splice and end lap locations</li> <li>• Actual framing member and location per manufacture</li> <li>• All miscellaneous framing including deck support, deck closure, shear studs, etc.</li> <li>• Slab openings modeled with support framing around openings</li> <li>• Point load locations</li> <li>• Slab reinforcing modeled if specified in BXP</li> </ul>	
400	<p>Element modeling to include:</p> <ul style="list-style-type: none"> <li>• All framing accessory and fasteners modeled per expected installation</li> <li>• All slab reinforcing</li> <li>• Welds</li> <li>• Waterproofing</li> </ul>	

### B1010.20.40 21-02 10 10 20 40 Floor Decks, Slabs, and Toppings (Concrete)

Associated Masterformat Sections: 03 30 00 / 03 40 00 / 03 50 00

100	See <a href="#">B10</a>	
200	<p>Element modeling to include:</p> <ul style="list-style-type: none"> <li>• Type of structural concrete system (e.g. cast-in-place or precast)</li> <li>• Approximate geometry (e.g. depth) of structural elements</li> </ul>	

## Unifomat Omniclass

300	<p>Element modeling to include:</p> <ul style="list-style-type: none"> <li>• Specific sizes and locations of main concrete structural members modeled per defined structural grid with correct orientation</li> <li>• All sloping surfaces included in model element with exception of elements affected by manufacturer selection</li> </ul>	
350	<p>Element modeling to include:</p> <ul style="list-style-type: none"> <li>• Reinforcement called out, modeled if required by the BXP, typically only in congested areas</li> <li>• Chamfer</li> <li>• Pour joints and sequences to help identify reinforcing lap splice locations, scheduling, etc.</li> <li>• Expansion Joints</li> <li>• Embeds and anchor rods</li> <li>• Post-tension profile and strands modeled if required by the BXP</li> <li>• Penetrations for items such as MEP</li> <li>• Any permanent forming or shoring components</li> <li>• Shear reinforcing and stud rails</li> </ul>	
400	<p>Element modeling to include:</p> <ul style="list-style-type: none"> <li>• All reinforcement including post tension elements detailed and modeled</li> <li>• Finishes</li> </ul>	

### B1010.20.41 21-02 10 10 10 41 Precast Structural Double Tee (Concrete)

*Includes: Structural elements required for support of floor construction within basements and above grade. Includes columns, girders, beams, trusses, joists. Includes cast-in-place concrete, precast concrete, unit masonry, metal framed, and wood framed systems. Includes framed and sleeved openings for services. Includes Floor Construction Supplementary Components as appropriate*

Associated Masterformat Sections: 03 30 00 / 03 40 00 / 04 20 00 / 05 10 00 / 05 20 00  
05 21 23 / 05 42 00 / 05 44 00 / 06 11 00 / 06 13 00 / 06 13 26 / 06 17 33 / 06 17 36  
06 17 53 / 06 18 13 / 06 18 16 / 06 50 00

100	See <a href="#">B10B10</a>	
200	<p>Element modeling to include:</p> <ul style="list-style-type: none"> <li>• Approximate geometry (e.g. depth) of structural elements</li> </ul>	 <p>46 B1010.20 – LOD 200 Precast Structural Double Tee (Concrete)</p>

## Unifomat Omniclass

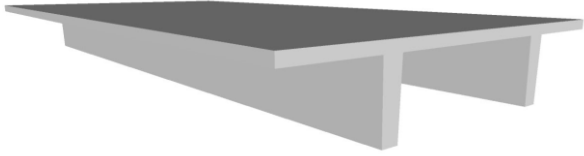
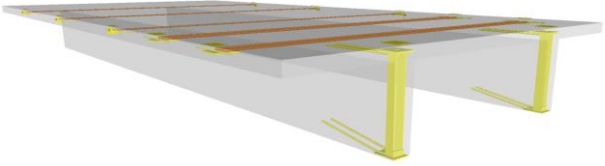
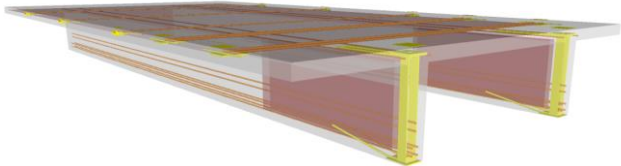
300	<p>Element modeling to include:</p> <ul style="list-style-type: none"> <li>• Specific sizes and locations of main concrete structural members modeled per defined structural grid with correct orientation</li> <li>• Concrete defined per spec (strength, air entrainment, aggregate size, etc.)</li> <li>• All sloping surfaces included in model element with exception of elements affected by manufacturer selection</li> </ul>	 <p><i>47 B1010.20 – LOD 300 Precast Structural Double Tee (Concrete)</i></p>
350	<p>Element modeling to include:</p> <ul style="list-style-type: none"> <li>• Reinforcing Post-tension profiles and strand locations</li> <li>• Reinforcement called out, modeled if required by the BXP, typically only in congested areas</li> <li>• Chamfer</li> <li>• Pour joints and sequences to help identify reinforcing lap splice locations, scheduling, etc.</li> <li>• Expansion Joints</li> <li>• Lifting devices</li> <li>• Embeds and anchor rods</li> <li>• Penetrations for items such as MEP</li> <li>• Any permanent forming or shoring components</li> </ul>	 <p><i>48 B1010.20 – LOD 350 Precast Structural Double Tee (Concrete)</i></p>
400	<p>Element modeling to include:</p> <ul style="list-style-type: none"> <li>• All reinforcement including post tension elements detailed and modeled</li> <li>• Finishes</li> </ul>	 <p><i>49 B1010.20 – LOD 400 Precast Structural Double Tee (Concrete)</i></p>

B1010.30	21-02 10 10 30	Balcony Floor Construction	TBD
B1010.40	21-02 10 10 40	Mezzanine Floor Construction	TBD
B1010.50	21-02 10 10 50	Ramps	TBD
B1010.90	21-02 10 10 50	Floor Construction Supplementary Components	TBD



## Unifomat Omniclass

### B1020 21-02 10 20 Roof Construction

Associated Masterformat Sections: 01 81 13

**Note:** This classification refers to roofs modeled as single composite objects (excluding structural frame). If individual layers are to be modeled refer to:

<a href="#">B1020.10</a>	21-02 10 20 10	Roof Structural Frame
<a href="#">B1020.20</a>	21-02 10 20 20	Roof Decks, Slabs, and Sheathing
<a href="#">B3010</a>	21-02 30 10	Roofing

### B1020.10 21-02 10 20 10 Roof Structural Frame

*Description: Structural elements required for support of floor construction within basements and above grade. Includes columns, girders, beams, trusses, joists. Includes cast-in-place concrete, precast concrete, unit masonry, metal framed, and wood framed systems. Includes framed and sleeved openings for services. Includes Floor Construction Supplementary Components as appropriate.*

Associated Masterformat Sections: 03 30 00 / 03 40 00 / 04 20 00 / 05 10 00 / 05 20 00 / 05 21 23 / 05 42 00 / 05 44 00 / 06 11 00 / 06 13 00 / 06 13 26 / 06 17 33 / 06 17 3606 17 53 / 06 18 13 / 06 18 16 / 06 50 00

[See [B1010.10](#)]

### B1020.20 21-02 10 20 20 Roof Decks, Slabs, and Sheathing

*Includes: Structural roof deck, slab, and sheathing construction. Includes cast-in-place concrete, precast concrete, cementitious decks and toppings, metal decking, wood sheathing, wood decking, timber decking and expansion control. Includes framed and sleeved penetrations for services and housekeeping pads for equipment. Includes Roof Construction Supplementary Components as appropriate.*

Associated Masterformat Sections: 03 30 00 / 03 40 00 / 03 50 00 / 03 52 00 / 05 30 00 / 05 34 00 / 05 35 00 / 06 12 00 / 06 15 00 / 06 16 00 / 06 18 00 / 06 53 00 / 06 73 00

100	N/A	
200	Generic roof objects separated by type of material Approximate thickness of layer represented by a single assembly. Layouts and locations still flexible.	
300	Penetrations are modeled to nominal dimensions for major roof openings such as skylights and large mechanical elements.	
350	All penetrations are modeled at actual rough-opening dimensions. Framing members at openings are modeled.	
400	Element modeling to include: <ul style="list-style-type: none"> <li>• Studs and tracks</li> <li>• Individual masonry units</li> <li>• Reinforcing</li> <li>• Sheathing</li> <li>• Insulation</li> </ul>	

## Unifomat Omniclass

### B1020.30 21-02 10 20 30 Canopy Construction

*Includes: Structural frame and decks, slabs, and sheathing for canopy construction.*

Associated Masterformat Sections: 03 30 00 / 03 40 00 / 05 10 00 / 05 19 19 / 05 20 00 / 06 11 00 / 06 12 00 / 06 13 00 / 06 15 00 / 06 16 00 / 06 17 00 / 06 18 00 / 06 50 00 / 06 73 00

[See [B1010.20](#)]

### B1020.90 21-02 10 20 90 Roof Construction Supplementary Components TBD

*Includes: Vapor retarders, air barriers, insulation, fireproofing, firestopping, and expansion control to be included with roof construction elements above as appropriate*

### B1080 21-02 10 80 Stairs

*Includes: Stairs, fire escapes, metal walkways, and ladders.*

Associated Masterformat Sections: 01 84 16

100	Assumptions for all stair systems (including railings, fire escapes, walkways, and ladders) are included in other modeled elements such as a spatial or massing element; or, schematic model element that indicates the approximate overall dimensions of the stair layout.	
-----	---	--

### B1080.10 21-02 10 80 10 Stair Construction

*Includes: Structural framing for exterior and interior stairs including treads, risers, and landings. Includes fire escapes and ladders.*

Associated Masterformat Sections: 03 11 23 / 03 30 00 / 03 41 23 / 03 48 19 / 05 51 00 / 05 55 00 / 05 71 00 / 06 43 00

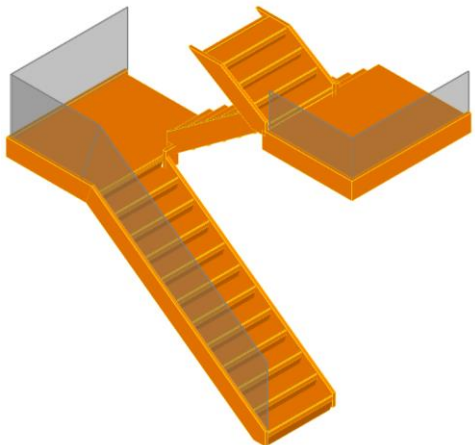
100	See <a href="#">B1080</a>	
200	<p>Generic model element with simplified treads and risers.</p> <p>Nominal overall unit scope shall include:</p> <ul style="list-style-type: none"> <li>• Nominal plan dimensions (length, width)</li> <li>• Nominal vertical dimensions (levels, landings)</li> </ul>	 <p>50 B1080.10-LOD-200 Stair Construction</p>

# Unifomat Omniclass

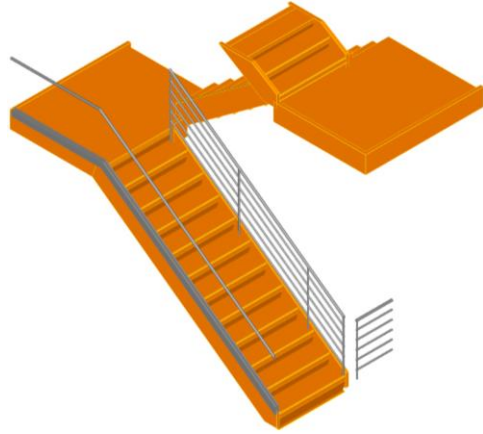
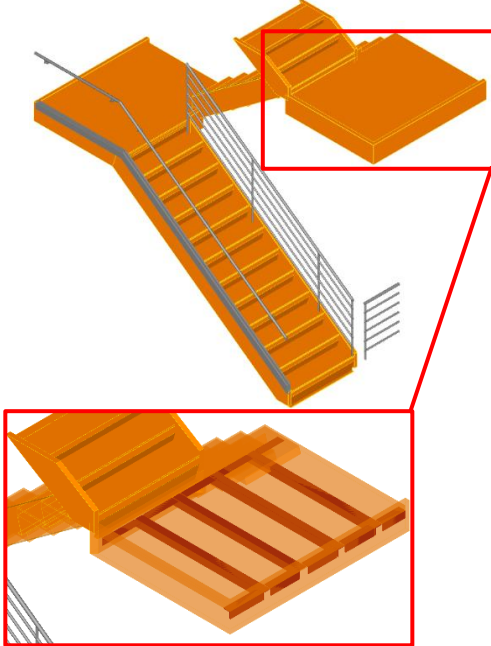
<p>300</p>	<p>Major stair support elements are modeled (stringers).</p> <p>Element is accurate as to</p> <ul style="list-style-type: none"><li>• Riser count</li><li>• Riser height</li><li>• Tread width</li><li>• Nosing conditions, including top and bottom</li><li>• Landing geometry</li></ul>	 <p>51 B1080.10-LOD-300 Stair Construction</p>
<p>350</p>	<p>Secondary stair support elements are modeled (hangers, brackets, handrail connection points etc.).</p>	 <p>52 B1080.10-LOD-350 Stair Construction</p>

# Unifomat Omniclass

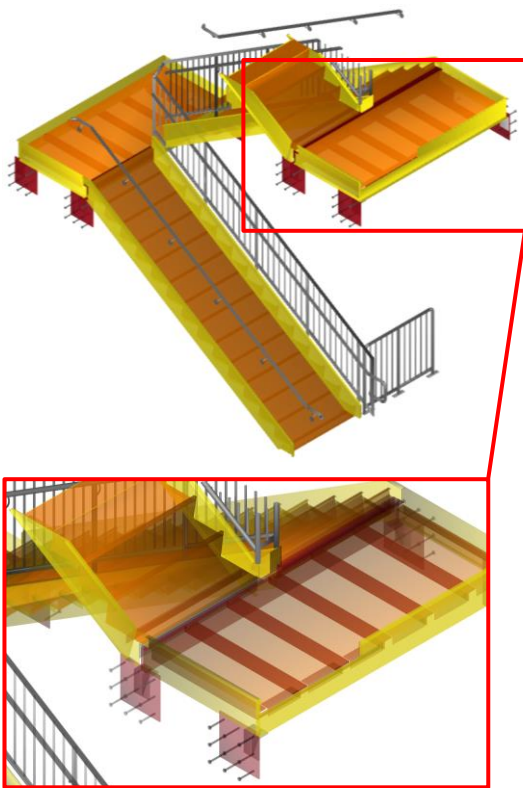
<p>400</p>	<p>All stair elements are modeled to support fabrication and installation.</p>	 <p>53 B1080.10-LOD-400 Stair Construction</p>
------------	--	---

## B1080.20 21-02 10 80 10 Precast Structural Stairs (Concrete)

*Includes: Structural framing for exterior and interior stairs including treads, risers, and landings. Includes fire escapes and ladders.*

Associated Masterformat Sections: 03 11 23 / 03 30 00 / 03 41 23 / 03 48 19 / 05 51 00  
05 55 00 / 05 71 00 / 06 43 00

<p>100</p>	<p>See <a href="#">B1080</a></p>	
------------	----------------------------------	--

# Unifomat Omniclass

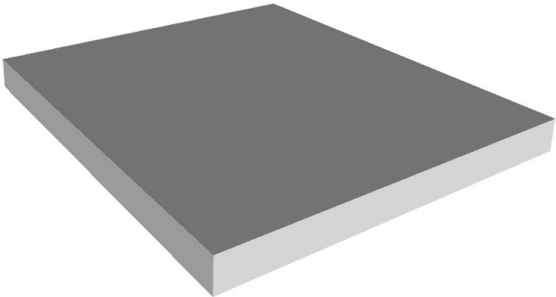
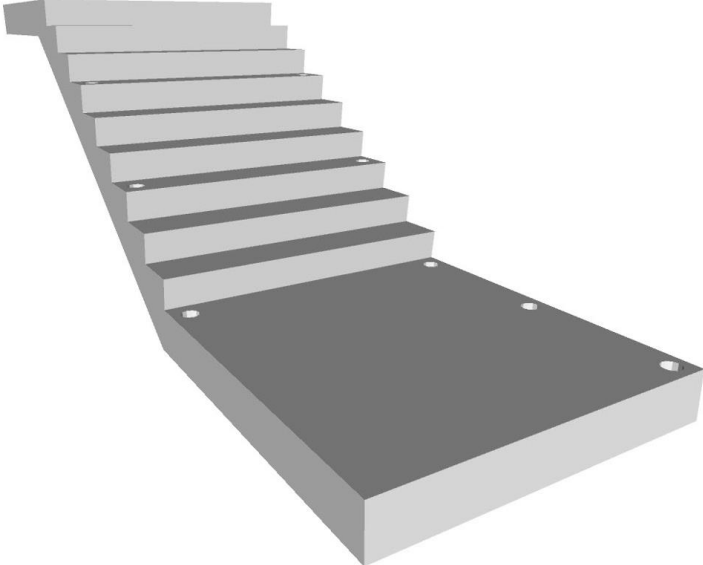
200	<p>Element modeling to include:</p> <ul style="list-style-type: none"><li>• Type of structural concrete system</li><li>• Approximate geometry (e.g. depth) of structural elements</li></ul>	  <p><i>55 B1080.10-LOD 200 Precast Structural Stairs (Concrete)</i></p>
300	<p>Element is accurate as to</p> <ul style="list-style-type: none"><li>• Riser count</li><li>• Riser height</li><li>• Tread width</li><li>• Nosing conditions, including top and bottom</li><li>• Landing geometry</li></ul>	 <p><i>56 B1080.10-LOD 300 Precast Structural Stairs (Concrete)</i></p>

# Unifomat Omniclass

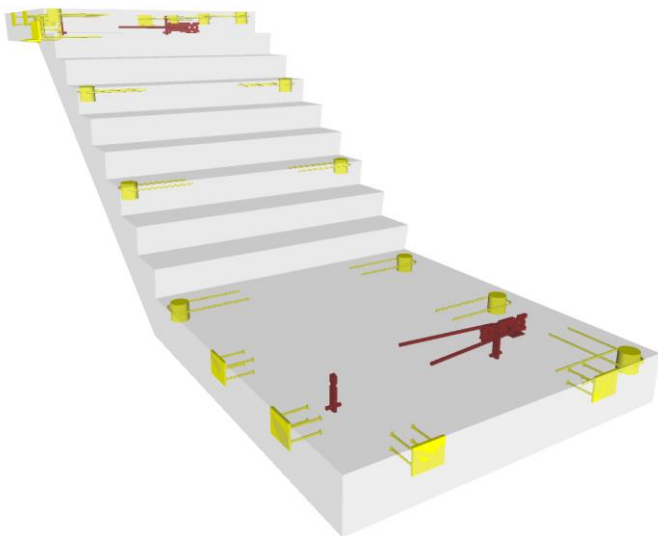
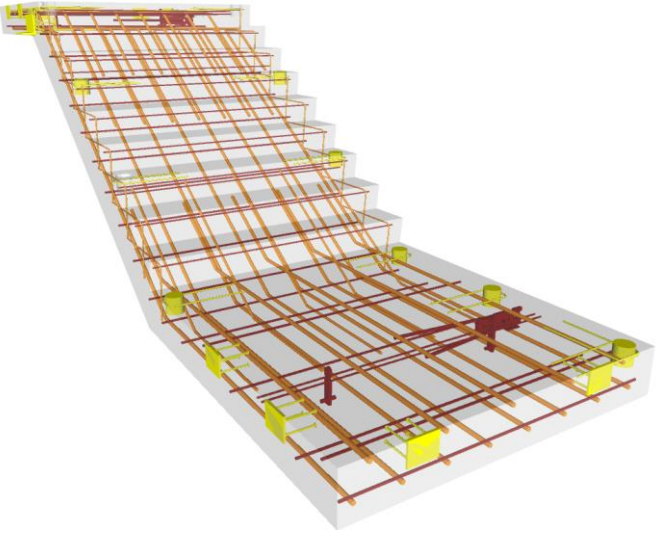
<p>350</p>	<p>Element modeling to include:</p> <ul style="list-style-type: none"> <li>• Reinforcing Post-tension profiles and strand locations</li> <li>• Reinforcement called out, modeled if required by the BXP, typically only in congested areas</li> <li>• Pour joints and sequences to help identify reinforcing lap splice locations, scheduling, etc.</li> <li>• Chamfer</li> <li>• Expansion Joints</li> <li>• Lifting devices</li> <li>• Embeds and anchor rods</li> <li>• Post-tension profile and strands modeled if required by the BXP</li> <li>• All penetrations modeled to rough opening dimensions.</li> <li>• Any permanent forming or shoring components</li> </ul>	 <p>57 B1080.10-LOD 350 Precast Structural Stairs (Concrete)</p>
<p>400</p>	<p>Element modeling to include:</p> <ul style="list-style-type: none"> <li>• All reinforcement including post tension elements detailed and modeled</li> <li>• Finishes, , etc.</li> </ul>	 <p>58 B1080.10-LOD 400 Precast Structural Stairs (Concrete)</p>

B1080.30

21-02 10 80 30

Stair Soffits

TBD

# Unifomat Omniclass

## B1080.50 21-02 10 80 50 Stair Railings

Associated Masterformat Sections: 05 15 00 / 05 52 00 / 05 73 00 / 06 43 16 / 06 63 00  
06 81 00

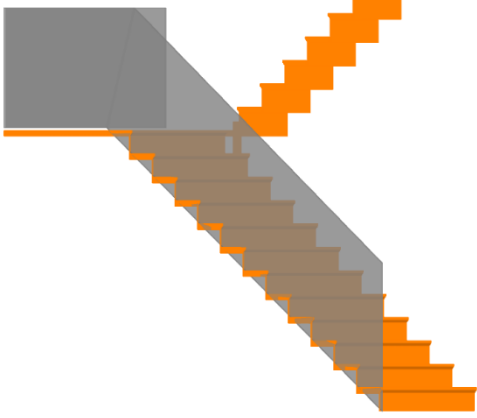
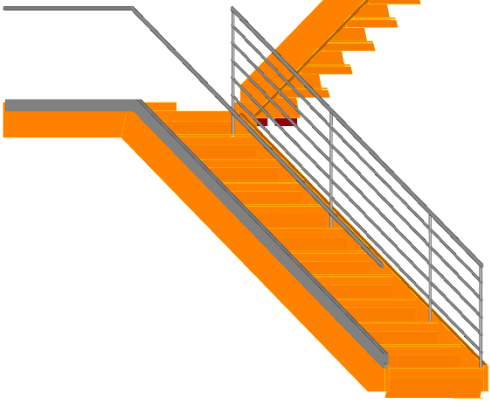
100	See <a href="#">B1080</a>	
200	Generic model elements without articulation of material or railing structure such as balusters, posts, or supports.	 <p><i>59 B1080.50-LOD-200 Stair Railings</i></p>
300	<p>Element is accurate as to</p> <ul style="list-style-type: none"> <li>• Railing geometry</li> <li>• railing element spacing</li> <li>• Supports for wall mounted railings</li> </ul>	 <p><i>60 B1080.50-LOD-300 Stair Railings</i></p>

# Unifomat Omniclass

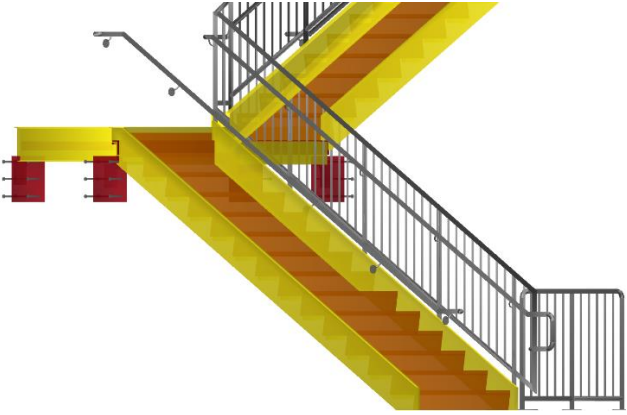
400	[See <a href="#">Fundamental LOD Definitions</a> ]	 <p>61 B1080.50-LOD-400 Stair Railings</p>
-----	--	--

## B1080.60 21-02 10 80 60 Fire Escapes

Associated Masterformat Sections: 05 51 23

[See [B1080.10](#) and [B1080.50](#)]

## B1080.70 21-02 10 80 70 Metal Walkways

Includes: Catwalks and gratings over horizontal openings

Associated Masterformat Sections: 05 51 36 / 05 51 36.13 / 05 53 00

[See [B1080.10](#) and [B1080.50](#)]

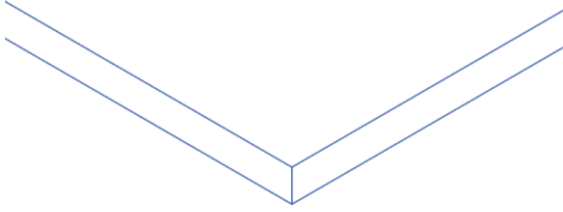
100	See B1080	
200	Grating type	 <p>B1080.70 LOD 200 Grating</p>

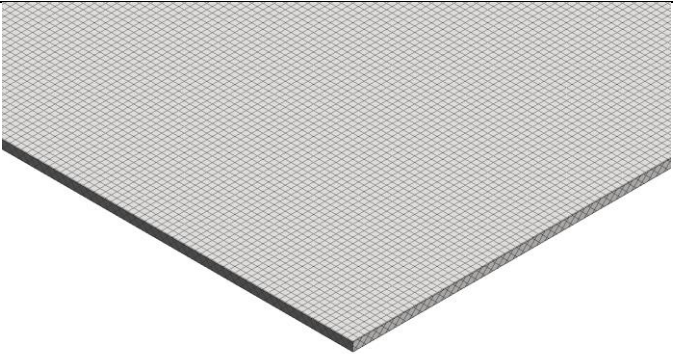
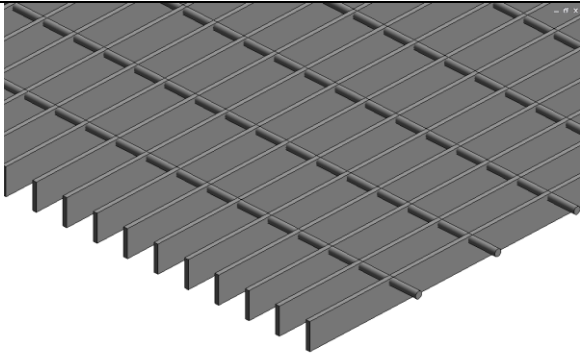

## Unifomat Omniclass

300	<p>Element modeling to include:</p> <ul style="list-style-type: none"> <li>• Grating type and overall geometry.</li> <li>• Thickness</li> <li>• Surface pattern showing span direction.</li> </ul>	 <p><i>B1080.70 LOD 300 Grating</i></p>
350	<p>Element modeling to include:</p> <ul style="list-style-type: none"> <li>• Panel layout and grating deck edges.</li> <li>• Banding, openings, and grating penetrations.</li> </ul>	 <p><i>B1080.70 LOD 350 Grating</i></p>
400	<p>Element modeling to include:</p> <ul style="list-style-type: none"> <li>• Full fabrication connections</li> </ul>	

**B1080.80**      21-02 10 80 80      Ladders  
Associated Masterformat Sections: 05 51 33 / 05 51 33.13 / 05 51 33.16 / 05 51 33.23

[See [B1080.10](#) and [B1080.50](#)]

## B20      21-02 20      Exterior Vertical Enclosures

Associated Masterformat Sections: 01 83 16

100	<p>Solid mass model representing overall building volume; or, schematic wall elements that are not distinguishable by type or material.</p> <p>Assembly depth/thickness and locations still flexible.</p>	
-----	---	--

# Unifomat Omniclass



## B2010 21-02 20 10 Exterior Walls

*Includes: Exterior Wall Supplementary Components as appropriate. Includes Exterior Wall Opening Supplementary Components as appropriate. Includes: Solid wall construction that is composite in nature; in other words, multiple layers of materials to form an overall assembly.*

Associated Masterformat Sections: 01 83 16

**Note:** This classification refers to walls modeled as single composite objects. If individual layers are to be modeled refer to:

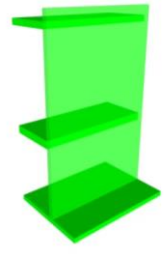
- [B2010.10](#) 21-02 20 10 10 Exterior Wall Veneer
- [B2010.20](#) 21-02 20 10 20 Exterior Wall Construction
- [B2010.30](#) 21-02 20 10 30 Exterior Wall Interior Skin

100	See <a href="#">B20</a>	
200	<p>Generic wall objects separated by type of material (e.g. brick wall vs. terracotta).</p> <p>Approximate overall wall thickness represented by a single assembly.</p> <p>Layouts and locations still flexible.</p>	 <p>62 B2010-LOD-200 Exterior Walls</p>
300	<p>Single model element with specific overall thickness that accounts for veneer, structure, insulation, air space, and interior skin specified for the wall system. (Refer to LOD350 and LOD400 for individually modeled elements)</p> <p>Penetrations are modeled to nominal dimensions for major wall openings such as windows, doors, and large mechanical elements.</p>	 <p>63 B2010-LOD-300 Exterior Walls</p>
350	<p>May be modeled as a single model element.</p> <p>Main structural members such as headers and jambs at openings are modeled.</p> <p>All penetrations are modeled at actual rough-opening dimensions.</p>	 <p>64 B2010-LOD-350 Exterior Walls</p>

# Unifomat Omniclass

## B2010.10 21-02 20 10 10 Exterior Wall Veneer

*Includes: Nonstructural outside face elements of exterior walls. Includes precast concrete, unit masonry, EIFS, manufactured siding, and stucco Includes water repellents, coatings, and painting.*

Associated Masterformat Sections: 03 40 00 / 04 20 00 / 04 26 13 / 04 42 00 / 04 43 13  
04 70 00 / 05 19 13 / 06 20 13 / 06 61 00 / 07 19 00 / 07 24 00 / 07 42 00 / 07 44 00  
07 46 00 / 09 24 00 / 09 24 23 / 09 90 00

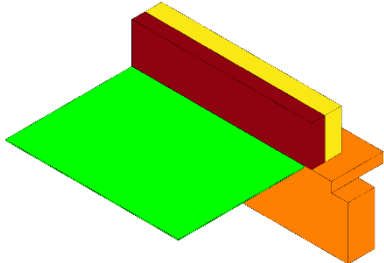
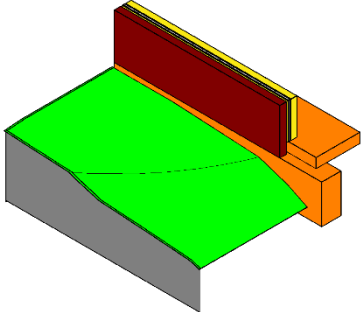
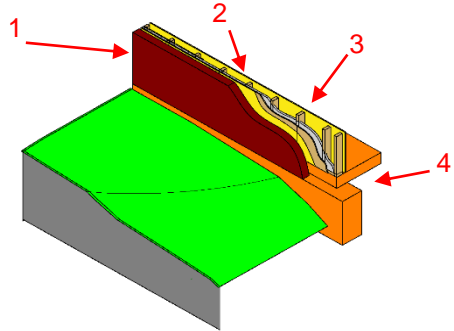
100	N/A	
200	<p>Generic wall objects separated by type of material (e.g. brick wall vs. terracotta).</p> <p>Approximate thickness of layer represented by a single assembly.</p> <p>Layouts and locations still flexible.</p>	 <p>65 B2010.10-LOD-200 Exterior Wall Veneer</p>
300	<p>Exterior wall veneer modeled as a separate element.</p> <p>Specific wall modeled to actual dimensions.</p> <p>Penetrations are modeled to nominal dimensions for major wall openings such as windows, doors, and large mechanical elements.</p>	 <p>66 B2010.10-LOD-300 Exterior Wall Veneer</p>
350	<p>Exterior wall veneer modeled as a separate element.</p> <p>All penetrations are modeled at actual rough-opening dimensions.</p> <p>Precast concrete panels are individually modeled. Connection points are specified.</p> <p>Connection to interfacing systems</p> <p><i>Images notes:</i></p> <ul style="list-style-type: none"> <li>• <i>Wall veneer element</i></li> </ul>	 <p>67 B2010.10-LOD-350 Exterior Wall Veneer</p>

# Unifomat Omniclass

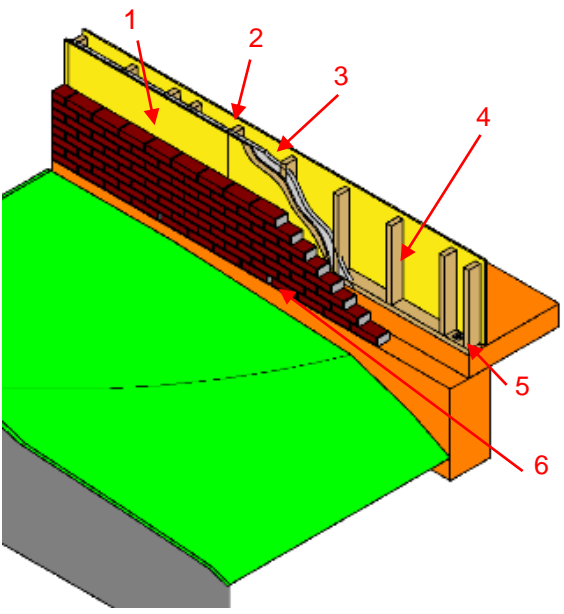
	<ul style="list-style-type: none"> <li>• Skin layers including but not limited to waterproofing membrane</li> <li>• Core framing</li> <li>• Concrete slab edge</li> </ul>	
400	<p>Element modeling includes:</p> <p><i>Image notes:</i></p> <ul style="list-style-type: none"> <li>• Individual masonry units</li> <li>• Skin layers including</li> <li>• Moisture barrier, sheathing, and insulation</li> <li>• Core framing</li> <li>• Bolt</li> <li>• Concrete slab edge</li> <li>• Weep holes</li> </ul>	 <p>68 B2010.10-LOD-400 Exterior Wall Veneer</p>

## B2010.20 21-02 20 10 20 Exterior Wall Construction

*Includes: Exterior wall construction including backup systems for wall veneer. May be vertical load bearing. Includes cast-in-place concrete walls, precast concrete walls, unit masonry walls, metal framed wall systems, and wood framed wall systems.*

Associated Masterformat Sections: 03 30 00 / 03 40 00 / 04 20 00 / 05 41 00 / 06 11 00  
06 12 00 / 06 16 00

100	N/A	
200	<p>Generic wall objects separated by type of material (e.g. brick wall vs. terracotta).</p> <p>Approximate thickness of layer represented by a single assembly.</p> <p>Layouts and locations still flexible.</p>	
300	Specific wall modeled to actual dimensions.	

## Unifomat Omniclass

	Penetrations are modeled to nominal dimensions for major wall openings such as windows, doors, and large mechanical elements.	
350	Exterior wall construction modeled as a separate element. All penetrations are modeled at actual rough-opening dimensions. Headers and jamb framing are modeled.	
400	Element modeling to include: <ul style="list-style-type: none"> <li>• Studs and tracks</li> <li>• Individual masonry units</li> <li>• Reinforcing</li> <li>• Sheathing</li> <li>• Insulation</li> </ul>	

### B2010.20.10 21-02 20 10 20 10 Exterior Wall Construction (Wood)

*Includes: Exterior Wall Supplementary Components as appropriate. Includes Exterior Wall Opening Supplementary Components as appropriate. Includes: Solid wall construction that is composite in nature; in other words, multiple layers of materials to form an overall assembly.*

Associated Masterformat Sections: 01 83 16

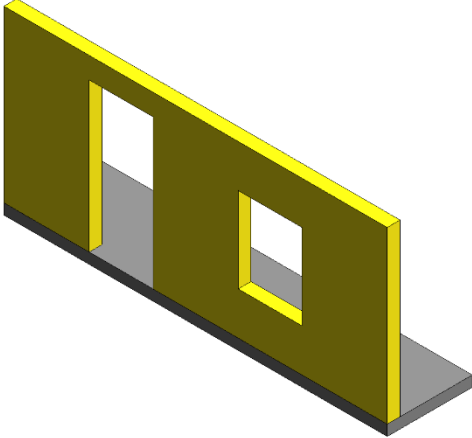
100	N/A	
200	Generic wall objects separated by type of material (e.g. brick wall vs. terracotta). Approximate thickness of layer represented by a single assembly. Layouts and locations still flexible.	 <p>69 B2010.06-LOD-200 Exterior Wall (Wood)</p>

# Unifomat Omniclass

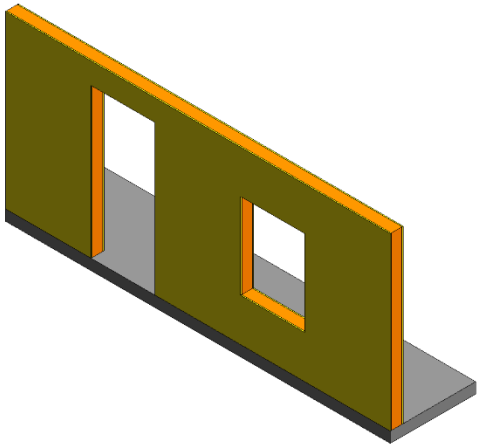
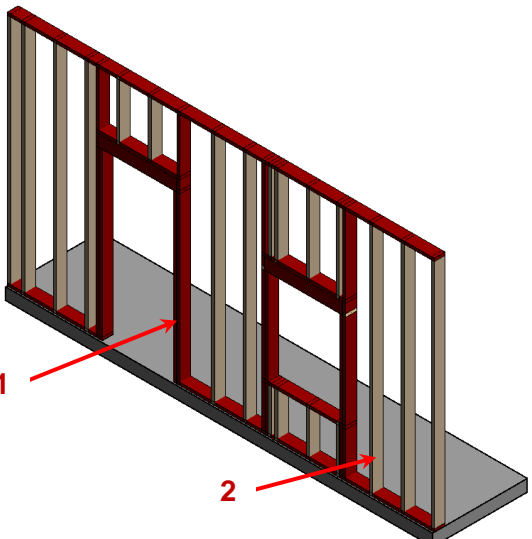
<p>300</p>	<p>Specific wall modeled to actual dimensions.</p> <p>Penetrations are modeled to nominal dimensions for major wall openings such as windows, doors, and large mechanical elements.</p> <p>Shear panels</p>	 <p>70 B2010.06-LOD-300 Exterior Wall (Wood)</p>
<p>350</p>	<p>Wood framing is developed with sufficient elements to support detailed interface coordination with other systems such as MEP.</p> <p>All penetrations are modeled at actual rough-opening dimensions.</p> <p>Openings modeled with support framing around openings</p> <p><i>Image notes:</i></p> <ol style="list-style-type: none"> <li>1) Elements in red are critical wall support elements that cannot be easily cut for coordination of MEP opening through the walls.</li> <li>2) Infill wood framing modeling may be omitted at this LOD if stated in the BXP.</li> <li>3) Cladding and sheathing are not shown for clarity in this image.</li> </ol>	 <p>71 B2010.06-LOD-350 Exterior Wall (Wood)</p>

# Unifomat Omniclass

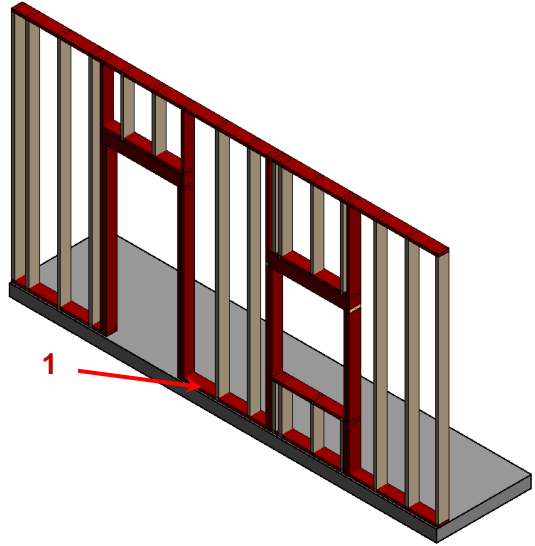
<p>400</p>	<p>Wood framing is developed with sufficient elements that support the fabrication of the wood framing system.</p> <p><i>Image notes:</i></p> <ol style="list-style-type: none"> <li>1) Connection content is development in the wall elements. This includes but is not limited to fasteners, anchor rods, and other related hardware.</li> <li>2) Cladding and sheathing are not shown for clarity in this image.</li> </ol>	 <p>72 B2010.06-LOD-400 Exterior Wall (Wood)</p>
------------	--	--

## B2010.20.20 21-02 20 10 20 20 Exterior Wall Construction (Cold-Form Metal Framing)

*Includes: Exterior Wall Supplementary Components as appropriate. Includes Exterior Wall Opening Supplementary Components as appropriate. Includes: Solid wall construction that is composite in nature; in other words, multiple layers of materials to form an overall assembly.*

Associated Masterformat Sections: 01 83 16

100	N/A	
-----	-----	--

## Unifomat Omniclass

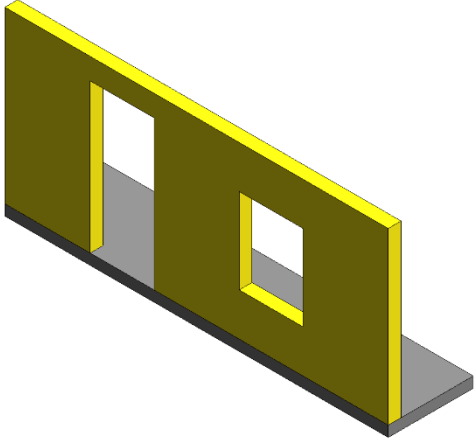
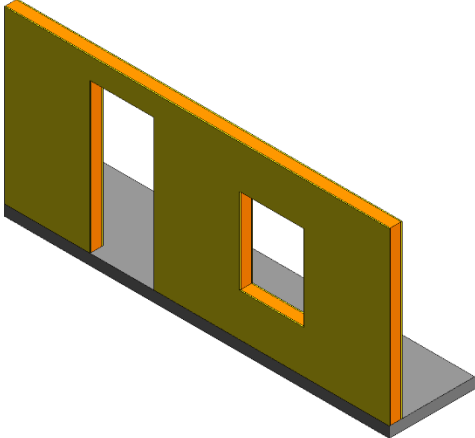
200	<p>Generic wall objects separated by type of material (e.g. brick wall vs. terracotta).</p> <p>Approximate thickness of layer represented by a single assembly.</p> <p>Layouts and locations still flexible.</p>	 <p><i>73 B2010.05-LOD-200 Exterior Wall (Cold-Form Metal Framing)</i></p>
300	<p>Specific wall modeled to actual dimensions.</p> <p>Penetrations are modeled to nominal dimensions for major wall openings such as windows, doors, and large mechanical elements.</p> <p>Shear panels</p>	 <p><i>74 B2010.05-LOD-300 Exterior Wall (Cold-Form Metal Framing)</i></p>

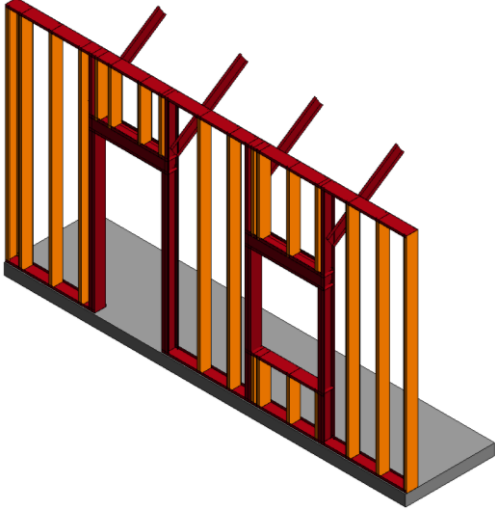

## Uniformat Omniclass

<p>350</p>	<p>Cold formed metal framing is developed with sufficient elements to support detailed interface coordination with other systems such as MEP.</p> <p>All penetrations are modeled at actual rough-opening dimensions.</p> <p>Openings modeled with support framing around openings</p> <p><i>Image notes:</i></p> <ul style="list-style-type: none"><li>• <i>Elements in red are critical wall support elements that cannot be easily cut for coordination of MEP opening through the walls.</i></li><li>• <i>Diagonal bracing (kickers) that may be in the above ceiling space are modeled for coordination with other building content such as MEP passing along the wall in the above ceiling spaces.</i></li><li>• <i>Infill cold formed metal framing modeling (Orange) may be omitted at this LOD if stated in the BXP.</i></li><li>• <i>Cladding and sheathing are not shown for clarity in this image.</i></li></ul>	 <p>75 B2010.05-LOD-350 Exterior Wall (Cold-Form Metal Framing)</p>
------------	--	---

# Unifomat Omniclass

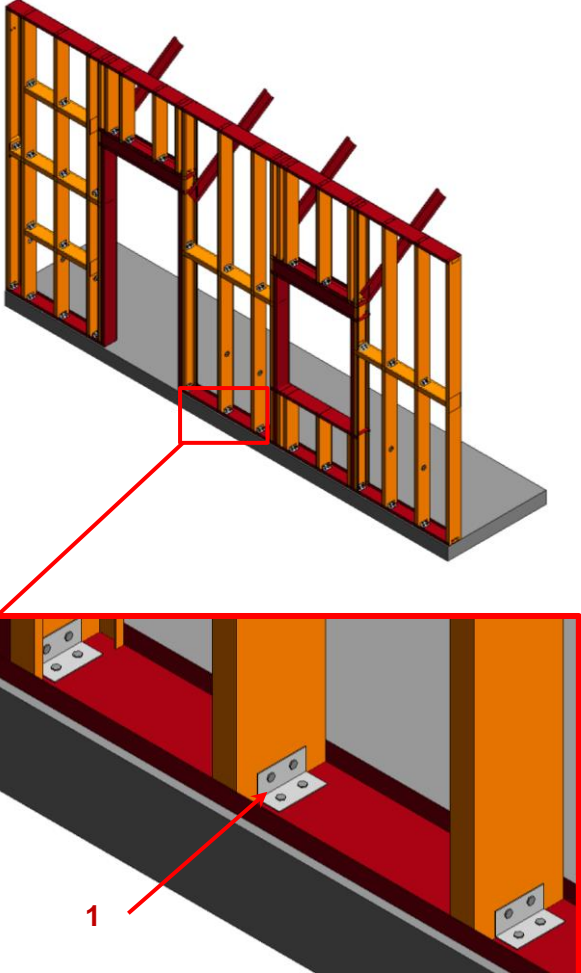
<p>400</p> <p>Cold formed metal framing is developed with sufficient elements that support the fabrication of the CFMF system.</p> <p><i>Image notes:</i></p> <ul style="list-style-type: none"> <li>• Connection content is development in the wall elements. This includes but is not limited to fasteners, clips, and other related hardware.</li> <li>• Cladding and sheathing are not shown for clarity in this image.</li> </ul>	 <p>76 B2010.05-LOD-400 Exterior Wall (Cold-Form Metal Framing)</p>
--	--

## B2010.20.30 21-02 20 10 20 30 Exterior Wall Construction (Masonry)

*Includes: Exterior Wall Supplementary Components as appropriate. Includes Exterior Wall Opening Supplementary Components as appropriate. Includes: Solid wall construction that is composite in nature; in other words, multiple layers of materials to form an overall assembly.*

Associated Masterformat Sections: 01 83 16

100	N/A	
-----	-----	--

## Unifomat Omniclass

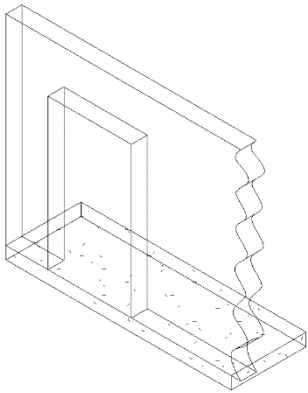
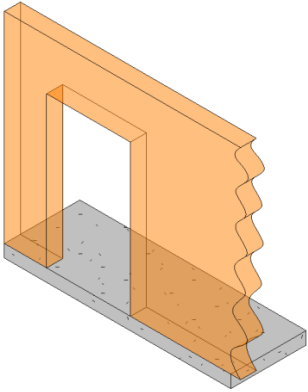
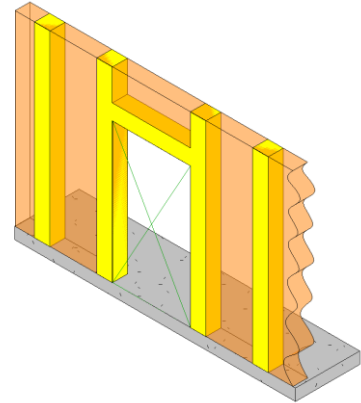
<p>200</p>	<p>Generic wall objects separated by type of material (e.g. brick wall vs. terracotta). Approximate thickness of layer represented by a single assembly. Layouts and locations still flexible.</p>	 <p><i>77 B2010.04-LOD-200 Exterior Wall (Masonry)</i></p>
<p>300</p>	<p>Specific wall modeled to actual dimensions. Penetrations are modeled to nominal dimensions for major wall openings such as windows, doors, and large mechanical elements. Shear panels</p>	 <p><i>78 B2010.04-LOD-300 Exterior Wall (Masonry)</i></p>
<p>350</p>	<p>Element modeling to include:</p> <ul style="list-style-type: none"> <li>• Members modeled at any interface with wall edges (top, bottom, sides) or opening through wall</li> <li>• All penetrations are modeled at actual rough-opening dimensions.</li> <li>• Openings modeled with support framing around openings</li> <li>• Any regions that would impact coordination with other systems such as but not limited to:             <ul style="list-style-type: none"> <li>○ Bond Beam &amp; Lintel Regions</li> <li>○ Reinforcing &amp; Embed Regions</li> <li>○ Jam Regions</li> <li>○ Any other grouted regions</li> </ul> </li> </ul>	 <p><i>79 B2010.04-LOD-350 Exterior Wall (Masonry)</i></p>

# Unifomat Omniclass

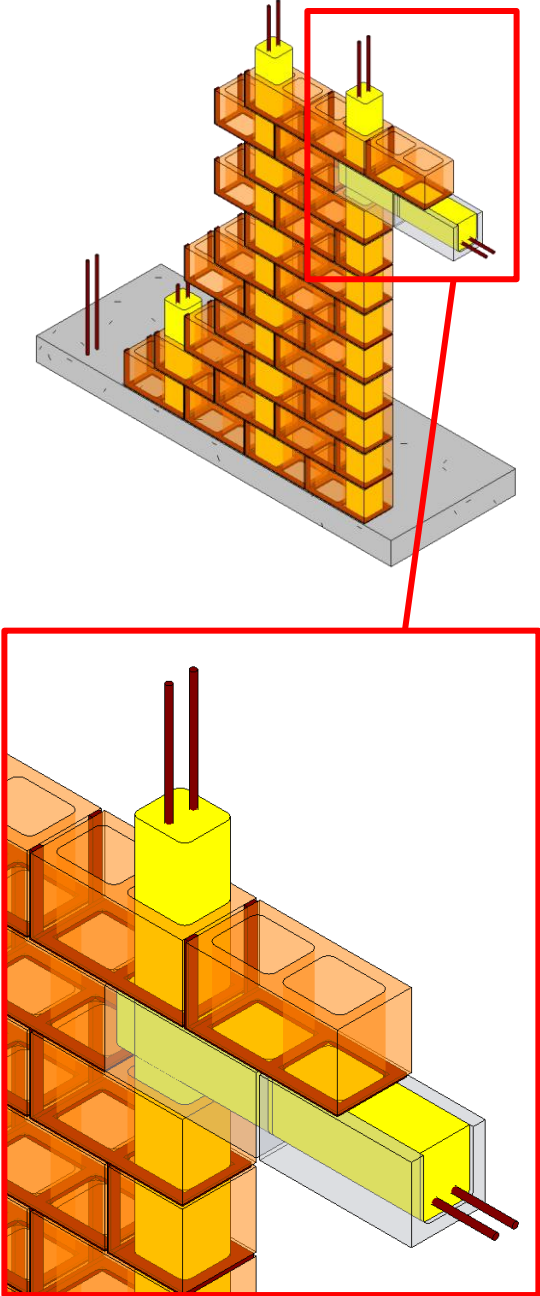
400	<p>Element modeling to include:</p> <ul style="list-style-type: none"><li>• Reinforcing</li><li>• Connections</li><li>• Grouting Material</li><li>• Jams</li><li>• Bond Beams</li><li>• Lintels</li><li>• Member fabrication part number</li><li>• Any part required for complete installation</li></ul>	 <p>The image shows a 3D perspective view of a masonry wall under construction. The wall is composed of orange-colored blocks. Reinforcing bars (rebar) are visible protruding from the top and bottom of the wall. A yellow grouting material is shown filling the voids between the blocks. A red box highlights a specific detail of the wall, showing a cross-section of a block with a rebar passing through it. A red line connects this detail to a larger, more detailed view of the same section, which is also enclosed in a red box. This detailed view shows the rebar passing through a yellow grout-filled cavity within the masonry block.</p> <p>80 B2010.04-LOD-400 Exterior Wall (Masonry)</p>
-----	--	---

## Unifomat Omniclass

### B2010.20.40 21-02 20 10 20 40 Precast Wall Construction (Concrete)

*Includes: Exterior wall construction including backup systems for wall veneer. May be vertical load bearing. Includes cast-in-place concrete walls, precast concrete walls, unit masonry walls, metal framed wall systems, and wood framed wall systems.*

Associated Masterformat Sections: 03 30 00 / 03 40 00 / 04 20 00 / 05 41 00 / 06 11 00  
06 12 00 / 06 16 00

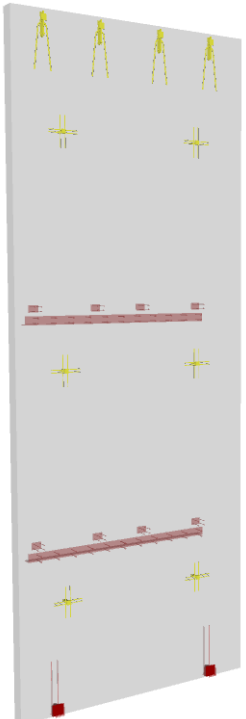
100	N/A	
200	<p>Generic wall objects separated by type of material (e.g. brick wall vs. terracotta).</p> <p>Approximate thickness of layer represented by a single assembly.</p> <p>Layouts and locations still flexible.</p>	
300	<p>Specific wall modeled to actual dimensions.</p> <p>Penetrations are modeled to nominal dimensions for major wall openings such as windows, doors, and large mechanical elements.</p> <p>Shear panels</p>	
350	<p>Element modeling to include:</p> <ul style="list-style-type: none"> <li>• Reinforcing Post-tension profiles and strand locations</li> <li>• Reinforcement called out, modeled if required by the BXP, typically only in congested areas</li> <li>• Pour joints and sequences to help identify reinforcing lap splice locations, scheduling, etc.</li> <li>• Expansion Joints</li> <li>• Lifting devices</li> <li>• Embeds and anchor rods</li> <li>• Post-tension profile and strands modeled if required by the BXP</li> <li>• All penetrations are modeled at actual rough-opening dimensions.</li> <li>• Any permanent forming or shoring components</li> <li>• Chamfer, reveals, etc.</li> </ul>	 <p>93 B2010.20– LOD 350 Precast Wall (Concrete)</p>

# Unifomat Omniclass

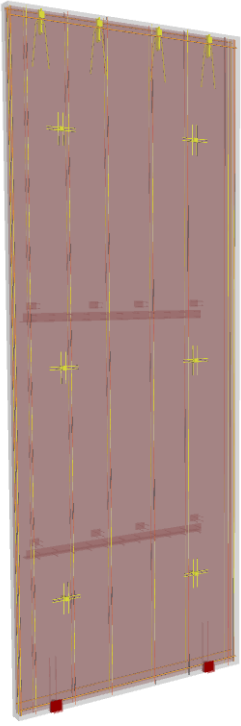
400	<p>Element modeling to include:</p> <ul style="list-style-type: none"> <li>All reinforcement including post tension elements detailed and modeled</li> </ul>	 <p>94 B2010.20- LOD 400 Precast Wall (Concrete)</p>
-----	--	--

## B2010.30 21-02 20 10 30 Exterior Wall Interior Skin

*Includes: Materials to provide finish or protective covering on inside of face of exterior walls. May include insulation and vapor retarder.*

Associated Masterformat Sections: 09 20 00

100	N/A	
200	<p>Generic wall objects separated by type of material (e.g. brick wall vs. terracotta).</p> <p>Approximate thickness of layer represented by a single assembly.</p> <p>Layouts and locations still flexible.</p>	
300	<p>Specific wall modeled to actual dimensions.</p> <p>Penetrations are modeled to nominal dimensions for major wall openings such as windows, doors, and large mechanical elements.</p>	

## Unifomat Omniclass

350	Exterior wall interior skin modeled as a separate element. All openings modeled to rough opening dimensions.	
400	Element modeling to include: <ul style="list-style-type: none"> <li>1) Studs and tracks <ul style="list-style-type: none"> <li>• Individual masonry units</li> <li>• Reinforcing</li> <li>• Wall board</li> <li>• Insulation</li> </ul> </li> </ul>	

### B2010.40      21-02 20 10 40      Fabricated Exterior Wall Assemblies      TBD

*Includes: Manufactured or fabricated assemblies that include exterior veneer and wall construction within one fabricated assembly and may also include interior skin. Includes Exterior Wall Supplementary Components as appropriate.*

Associated Masterformat Sections: 04 25 00 / 07 42 63 / 07 44 63 / 08 44 00 / 08 45 00

**Note:** For Curtain Walls see:

B2020.30                      21-02 20 20 30    Exterior Window Wall

### B2010.50      21-02 20 10 50      Parapets

*Includes: Exterior wall construction above plane of roof.*

Associated Masterformat Sections: 03 30 00 / 03 40 00 / 04 20 00 / 05 41 00 / 06 11 00  
06 12 00 / 06 16 00

[See [B2010](#), [B2010.10](#), [B2010.20](#), and [B2010.30](#)]

### B2010.60      21-02 20 10 60      Equipment Screens

*Includes: Exterior wall construction to screen equipment from public view.*

Associated Masterformat Sections: 03 40 00 / 04 20 00 / 08 92 00

[See [B2010](#), [B2010.10](#), [B2010.20](#), and [B2010.30](#)]

### B2010.80      21-02 20 10 80      Exterior Wall Supplementary Components      TBD

### B2010.90      21-02 20 10 90      Exterior Wall Opening Supplementary Components      TBD

## B2020      21-02 20 20      Exterior Windows

*Includes: Fixed or operable windows used singly and in multiples located in the exterior vertical enclosure. Includes Exterior Window Supplementary Components as appropriate. Includes windows units with louver blinds integrally set between glass panels. Includes metal, wood, plastic, and composite window units. May Include: Wall Opening Supplementary Components as appropriate.*

Associated Masterformat Sections: 01 83 16 / 08 50 00

100	See <a href="#">B20</a>	
-----	-------------------------	--

## Uniformat Omniclass

200	Windows approximate in terms of location, size, count and type. Units are modeled as a simple, monolithic component; or represented with simple frame and glazing.  Nominal unit size is provided.	
-----	--	--

### B2020.10 21-02 20 20 10 Exterior Operating Windows

*Includes: Window screens and storm windows.*

Associated Masterformat Sections: 08 50 00 / 08 51 66 / 08 52 66 / 08 53 66 / 08 54 66  
08 51 69 / 08 52 69 / 08 53 69 / 08 54 69

100	See <a href="#">B20</a>	
200	See <a href="#">B2020</a>	
300	Units are modeled based on specified location and nominal size. Outer geometry (profile) of window frame elements and glazing modeled in correct location  Operation is indicated.	
350	Attachment method of window to structure  Embed elements  Backer rod and sealant	
400	Detailed frame extrusion profiles  Glazing sub-components (gaskets)  Attachment components  1) End dam 2) Fasteners	

### B2020.20 21-02 20 20 20 Exterior Fixed Windows

Associated Masterformat Sections: 08 50 00

[See [B2020.10](#)]

### B2020.30 21-02 20 20 30 Exterior Window Wall

Associated Masterformat Sections: 08 43 00

100	See <a href="#">B20</a>	
-----	-------------------------	--

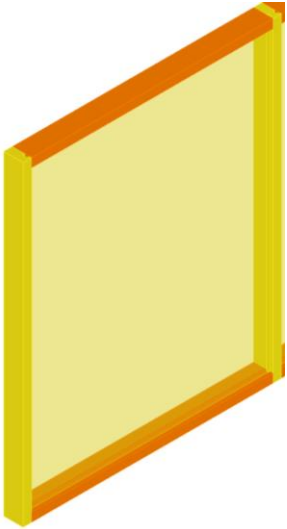

## Unifomat Omniclass

<p>200</p>	<p>Generic wall objects representing major types of proposed window wall assemblies.</p> <p>Overall window wall assembly depth represented by a single model object.</p> <p>Layouts and locations still flexible.</p>	 <p><i>95 B2020.30-LOD-200 Exterior Window Wall</i></p>
<p>300</p>	<p>Specified location and orientation of face of glass.</p> <p>Nominal face dimensions and thickness of glazing.</p> <p>Spacing, location, size and orientation of mullions.</p> <p>Operable components defined (windows, louvers and doors) and included in model.</p>	 <p><i>96 B2020.30-LOD-300 Exterior Window Wall</i></p>

# Unifomat Omniclass

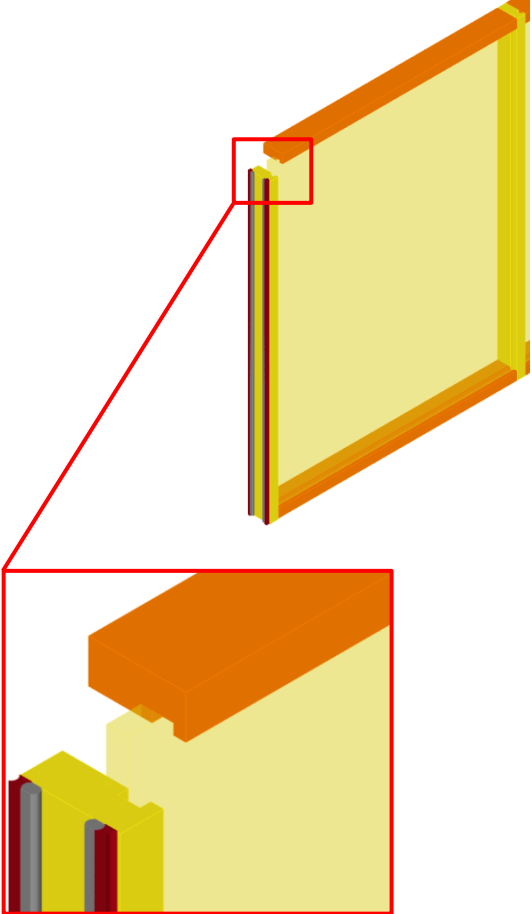
<p>350</p>	<p>Mullion shapes and geometry defined. Actual anchorage layouts and types defined and modeled. Actual panel dimensions (including seating).</p>	 <p>The image shows a 3D perspective view of a window wall assembly. A yellow rectangular panel is mounted on a brown mullion. A red box highlights the top edge of the mullion where it meets the panel. A red line extends from this box to a larger, more detailed inset view below. This inset view shows the mullion's profile, which has a complex, multi-faceted shape designed to hold the panel in place. The panel is shown seated within the mullion's profile.</p> <p>97 B2020.30-LOD-350 Exterior Window Wall</p>
------------	--	---

# Unifomat Omniclass

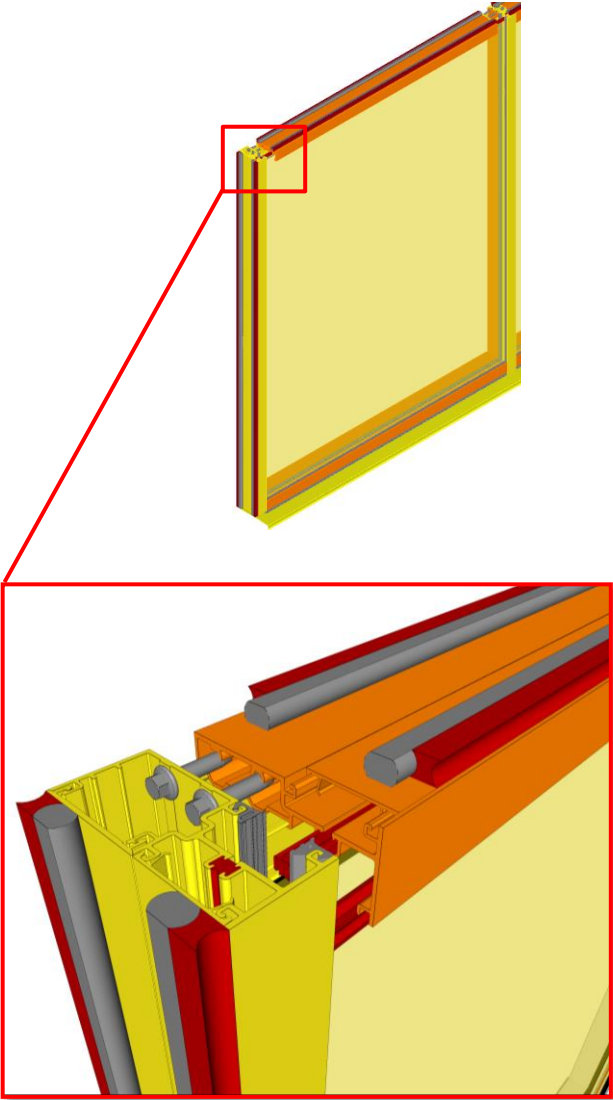
<p>400</p>	<p>Complete mullion extrusion profiles. Interface details between wall systems (within) and wall and support systems including sealants, end dams, flashings and membranes.</p>	 <p>98 B2020.30-LOD-400 Exterior Window Wall</p>
------------	---	---

## B2020.50 21-02 20 20 50 Exterior Special Function Windows

*Includes: Exterior windows with special characteristics for a special function.*

Associated Masterformat Sections: 08 56 00 / 08 55 00 / 08 88 39 / 08 56 19 / 08 56 46  
08 56 49 / 08 88 49 / 08 56 53 / 08 88 53 / 08 88 56 / 08 56 63 / 08 56 73 / 08 75 00  
08 80 00

[See [B2020.10](#)]



## Unifomat Omniclass

### B2050 21-02 20 50 Exterior Doors and Grilles

Includes: Doors, grilles, and gates located in the exterior vertical enclosure. Includes screen and storm door assemblies. Includes Exterior Door Supplementary Components as appropriate. May Include: Wall Opening Supplementary Components as appropriate.

Associated Masterformat Sections: 01 83 16

100	Simple representation of a door unit. Size, count, and location are approximate.	
200	Units are modeled as a simple, monolithic component; or represented with simple frame and panel.  Nominal unit size is provided.	

### B2050.10 21-02 20 50 10 Exterior Entrance Doors

Includes: Exterior personnel door assemblies at main entrances. Includes automatic, revolving, balanced, and other special operating entrance doors, and sliding storefront wall systems.

Associated Masterformat Sections: 08 32 00 / 08 42 00 / 08 42 26 / 08 42 29 / 08 42 33  
08 42 36 / 08 43 29

100	See <a href="#">B20</a>	
200	See <a href="#">B2050</a>	
300	Entrance door assemblies modeled by type to include the following:  Specific door panels and frames (if applicable).  Operation is specified. Spatial requirements for operation may be modeled if required by BXP.	
350	Major framing elements are modeled at jambs and head.  Thresholds  Operation or mechanism enclosures are modeled.  All connections and interfaces modeled including brackets and supports.	
400	Complete mullion extrusion profiles Actual panel size dimensions.	

### B2050.20 21-02 20 50 20 Exterior Utility Doors

Includes: Exterior personnel door assemblies other than at main entrances.

Associated Masterformat Sections: 08 10 00

## Unifomat Omniclass

100	See <a href="#">B20</a>	
200	See B2050	
300	See B2050.10	
350	See B2050.10	
400	All connections and interfaces modeled including brackets, supports, sealants, and thresholds.	

### B2050.30 21-02 20 50 30 Exterior Oversize Doors

*Includes: Large exterior door assemblies to allow for passage of large objects involving various operating methods. Includes Exterior Door Supplementary Components as appropriate including operators and drive mechanisms.*

Associated Masterformat Sections: 08 33 00 / 08 36 00 / 08 36 13 / 08 36 16 / 08 36 19  
08 36 23 / 08 34 16

100	See <a href="#">B20</a>	
200	See <a href="#">B2050</a>	
300	Oversize door assemblies modeled by type to include the following:  Door panels with nominal dimensions.  Frames with nominal dimensions.  Clearance zones are modeled or accommodated by model checking software for operation of overhead doors (other than coiling doors).  Enclosures and motor housings are modeled with overall nominal dimensions.	
350	Major framing elements in wall are modeled at jambs and head.  Attachment elements are modeled	
400	All connections and interfaces modeled including brackets, supports, sealants, and thresholds.	

### B2050.40 21-02 20 50 40 Exterior Special Function Doors

*Includes: Exterior door assemblies for a variety of special functions and applications involving a variety of operating methods. Includes Exterior Door Supplementary Components as appropriate including controls and operators.*

Associated Masterformat Sections: 08 30 00 / 08 34 13 / 08 34 19 / 08 34 46 / 08 34 49  
08 34 53 / 08 34 63 / 08 34 73 / 08 38 00 / 08 39 00 / 08 88 49 / 08 88 53 / 08 88 56

[See [B2050.20](#) or [B2050.30](#)]

### B2050.60 21-02 20 50 60 Exterior Grilles

*Includes: Exterior devices of open construction to provide moveable barrier to provide access through wall or other divider.*

Associated Masterformat Sections: 08 33 00 / 08 35 16

[Back to TOC](#)



Copyright © 2017 by BIMForum. All rights reserved

This document is copyrighted under a [Creative Commons Attribution-NonCommercial-NoDerivatives 4.0 International License](#).

## Uniformat Omniclass

100	See <a href="#">B20</a>	
200	See <a href="#">B2050</a>	
300	Grille assemblies modeled by type to include the following: Nominal size of unit. Operation is specified.	
350	Major framing elements are modeled at jambs and head.	
400	All connections and interfaces modeled including brackets, supports, sealants, and thresholds.	

### B2050.70 21-02 20 50 70 Exterior Gates

*Includes: Exterior devices of solid or open construction to provide moveable barrier to provide access through wall or other divider.*

Associated Masterformat Sections: 08 34 56

[See [B2050.60](#)]

### B2050.90 21-02 20 70 Exterior Door Supplementary Components

*Includes frames, hardware, glazing and louvers that are part of door to be included with exterior door elements above as appropriate.*

**These components are typically modeled as part of other assemblies listed in the tables above. Do not assign this Uniformat classification unless a supplementary component is modeled independently of another assembly.**

Associated Masterformat Sections: 08 10 00 / 08 30 00 / 08 71 00 / 08 80 00 / 08 91 26

## B2070 Exterior Louvers and Vents

*Includes: Exterior louvers which are not an integral part of mechanical equipment, including louvers connected to ducts.*

Associated Masterformat Sections: 08 90 00

100	See <a href="#">B20</a>	
200	Generic model element that is indicative of approximate area and location of intended louver/vent.	

### B2070.10 21-02 20 70 10 Exterior Louvers

Associated Masterformat Sections: 01 83 16 / 08 91 00

100	See <a href="#">B20</a>	
200	See <a href="#">B2070</a>	
300	Louver assembly modeled by type, indicative of area and location of intended louver/vent.  Accurate frame and blade boundary areas.  Opening for louver is cut from host wall	

## Unifomat Omniclass

350	Major framing elements are modeled at connection points. Connection points are modeled.	
400	All connections and interfaces modeled including brackets, supports, and sealants.	

### B2070.50 21-02 20 70 50 Exterior Vents

Associated Masterformat Sections: 08 95 00

[See [B2070.10](#)]

### B2080 21-02 20 80 Exterior Wall Appurtenances

*Includes: Exterior enclosures, grilles and screens of wood, metal, plastic, and other materials for a variety of purposes including screening of equipment.*

Associated Masterformat Sections:

[See [B2050](#)]

### B2080.10 21-02 20 80 10 Exterior Fixed Grilles and Screens

*Includes: Exterior enclosures, grilles and screens of wood, metal, plastic, and other materials for a variety of purposes including screening of equipment.*

Associated Masterformat Sections: 05 70 00 / 06 49 00 / 06 60 00 / 06 80 00 / 10 82 13

[See [B2050.60](#)]

### B2080.30 21-02 20 80 30 Exterior Opening Protection Devices

*Includes: Manufactured items such as louvers, fins, shutters, demountable panels, awnings, and sun screens to provide sun control, privacy, security, insulation, and storm protection on exterior of windows, skylights, and entrances. Includes fixed and moveable, manually and electrically operated, and automatically controlled devices.*

Associated Masterformat Sections: 10 71 00 / 10 71 13 / 10 71 16 / 10 73 13

[See [B2010.60](#)]

### B2080.50 21-02 20 80 50 Exterior Balcony Walls and Railings

*Includes: Exterior enclosures, grilles and screens of wood, metal, plastic, and other materials for a variety of purposes including screening of equipment.*

Associated Masterformat Sections: 03 30 00 / 03 40 00 / 04 20 00 / 05 41 00 / 06 11 00  
06 16 00 / 05 52 00 / 05 73 00 / 06 43 16 / 06 63 00 / 06 81 00

[See [B2010.50](#)]

### B2080.70 21-02 20 80 70 Exterior Fabrications

*Includes: Exterior fabrications of a variety of materials formed to various profiles for a variety of purposes including column covers, decorative metal, ornamental woodwork, and plaster fabrications.*

## Unifomat Omniclass

Associated Masterformat Sections: 03 49 00 / 05 50 00 / 05 58 13 / 05 70 00 / 06 44 00  
06 60 00 / 06 61 00 / 06 80 00 / 09 27 00

[See [Fundamental LOD Definitions](#)]

### B2080.80 21-02 20 80 80 Bird Control Devices

*Includes: Mechanical, electrical, physical, and chemical repellent systems, and protective devices.*

Associated Masterformat Sections: 10 81 13

[See [Fundamental LOD Definitions](#)]

### B2090 21-02 20 90 Exterior Wall Specialties

*Includes: Complete fabrication of metal, wood, and fiberglass, including accessories and appurtenances. For example, clocks, below-grade egress assemblies, and window wells.*

Associated Masterformat Sections: 07 77 00 / 10 74 00 / 10 74 13 / 10 74 43 / 10 74 46

[See [Fundamental LOD Definitions](#)]

## B30 21-02 30 Exterior Horizontal Enclosures

Associated Masterformat Sections: 01 83 16

100	Solid mass model representing overall building volume; or, schematic wall elements that are not distinguishable by type or material.  Assembly depth/thickness and locations still flexible.	
-----	--	--

## B3010 21-02 30 10 Roofing

Associated Masterformat Sections: 01 83 19

100	See <a href="#">B30</a>	
200	Generic element representing roof exterior skin	
300	Specific element representing roof insulation and exterior skin modeled to actual dimensions.  Surface slopes (e.g. tapered insulation) are modeled to actual dimensions.  Penetrations are modeled to nominal dimensions for major wall openings such as skylights, and large mechanical elements.	
350	All penetrations are modeled at actual rough-opening dimensions.  Flashing	



## Uniformat Omniclass

### B3010.10 21-02 30 10 10 Steep Slope Roofing

*Includes: Lapped roofing shingles, shakes and roofing tiles, including fastening and flashing products and methods. Includes Roofing Supplementary Components as appropriate.*

Associated Masterformat Sections: 01 83 19 / 07 30 00 / 07 31 00 / 07 32 00 / 07 41 00  
07 61 00 / 07 63 00

[\[See B3010\]](#)

### B3010.50 21-02 30 10 50 Low-Slope Roofing

*Includes: Membrane roofing of various types and protected membrane roofing, including fastening and flashing products. Includes Roofing Supplementary Components as appropriate.*

Associated Masterformat Sections: 01 83 19 / 07 50 00 / 07 55 00 / 07 55 63 / 07 76 00

[\[See B3010\]](#)

### B3010.70 21-02 30 10 70 Canopy Roofing

*Includes: Roofing of various types over canopies. Includes Roofing Supplementary Components as appropriate.*

Associated Masterformat Sections:

[\[See B1020\]](#)

### B3010.70 21-02 30 10 70 Canopy Roofing

*Includes: Roofing of various types over canopies. Includes Roofing Supplementary Components as appropriate.*

Associated Masterformat Sections:

[See [B3010.10](#) or [B3010.50](#)]

### B3010.90 21-02 30 10 90 Roofing Supplementary Components

*Includes: substrate boards, vapor retarder, air barriers, deck insulation, flashing and sheet metal, and expansion joints to be included with roofing elements above as appropriate.*

**These components are typically modeled as part of other assemblies listed in the tables above. Do not assign this Uniformat classification unless a supplementary component is modeled independently of another assembly.**

Associated Masterformat Sections: 07 22 00 / 07 26 00 / 07 27 00 / 07 62 00 / 07 65 00  
07 71 13 / 07 71 16 / 07 71 19 / 07 71 29 / 09 28 00

## B3020 21-02 30 20 Roof Appurtenances

*Includes: Roof specialties and accessories installed on or in roofing or traffic bearing horizontal enclosure systems. Includes components for the management of rainwater, but excludes mechanical and structural items.*

Associated Masterformat Sections:

100	See <a href="#">B30</a>	
200	See <a href="#">Fundamental LOD Definitions</a>	

## Unifomat Omniclass

### B3020.10 21-02 30 20 10 Roof Accessories

*Includes: Ladders, curbs, vents, walkways, and snow guards.*

Associated Masterformat Sections: 05 51 33 / 07 72 00 / 07 72 13 / 07 72 23 / 07 72 26  
07 72 46 / 07 72 53

100	See <a href="#">B30</a>	
200	See <a href="#">Fundamental LOD Definitions</a>	
300	<p><b>Ladders:</b> Specific assemblies indicating length and width. Required access/clearance space is modeled or accommodated by model checking software.</p> <p><b>Walkways:</b> Specific assemblies indicating length, width, and rail/guard height.</p> <p><b>Vents:</b> Specific assemblies indicating roof opening size. Roof opening element is included. Required service access space is modeled or accommodated by model checking software.</p>	
350	<p><b>Ladders:</b> Specific assemblies indicating length, width, and attachment/anchoring members.</p> <p><b>Walkways:</b> Specific assemblies indicating length, width, rail/guard height, and support/attachment/anchoring members.</p> <p><b>Vents:</b> Specific assemblies indicating roof opening size and attachment/anchoring members if applicable.</p>	
400	See <a href="#">Fundamental LOD Definitions</a>	

### B3020.30 21-02 30 20 30 Roof Specialties

*Includes: Cupolas, spires, steeples, and weathervanes.*

Associated Masterformat Sections: 10 74 00 / 10 74 23 / 10 74 26 / 10 74 29 / 10 74 33

[\[See Fundamental LOD Definitions\]](#)

### B3020.70 21-02 30 20 70 Rainwater Management

*Includes: Components to manage rain water from roofing and traffic bearing horizontal enclosures. Includes: Conductor heads, gutters, downspouts, scuppers, and splash blocks.*

Associated Masterformat Sections: 07 71 23 / 07 71 33 / 03 48 16

[See [D2030.10](#) and [D2030.20](#)]

### B3040 21-02 30 40 Traffic Bearing Horizontal Enclosures

*Includes: Horizontal enclosures that are also traffic bearing. Includes Horizontal Enclosure Supplementary Components as appropriate.*

Associated Masterformat Sections: 01 83 16

100	See <a href="#">B30</a>	
200	See <a href="#">B3010</a>	

## Uniformat Omniclass

### B3040.10 21-02 30 40 10 Traffic Bearing Coatings

*Includes: Surface applied waterproofing exposed to weather and suitable for pedestrian or vehicular traffic.*

Associated Masterformat Sections: 07 18 00

### B3040.30 21-02 30 40 30 Horizontal Waterproofing Membrane

*Includes: Substrate board, deck insulation, vapor retarder, sheet metal flashing and trim, flexible flashing, and expansion joints.*

Associated Masterformat Sections: 07 10 00

100	See <a href="#">B30</a>	
200	See <a href="#">B3040</a>	
300	Membrane assembly modeled by type to specified thickness. Major openings such as shafts and hatches are modeled.	
350	Individual material layers of membrane assembly are modeled separately. All openings and penetrations are modeled. Expansion joints are modeled indicating specific width.	

### B3040.50 21-02 30 40 50 Wear Surfaces

*Includes: Wearing surfaces on top of horizontal waterproofing membrane that are suitable for pedestrian or vehicular traffic.*

Associated Masterformat Sections: 07 76 00 / 32 13 00 / 32 14 00

100	See <a href="#">B30</a>	
200	See <a href="#">B3040</a>	
300	Wear surface system modeled by type to specified thickness/depth. Major openings such as shafts and hatches are modeled.	
350	Individual system elements are modeled separately. Pedestals are modeled and located properly, if applicable. Expansion joints are modeled indicating specific width.	

### B3040.90 21-02 30 40 90 Horizontal Enclosure Supplementary Components

*Includes: Substrate board, deck insulation, vapor retarder, sheet metal flashing and trim, flexible flashing, and expansion joints to be included with horizontal enclosure elements above as appropriate.*

**These components are typically modeled as part of other assemblies listed in the tables above. Do not assign this Uniformat classification unless a supplementary component is modeled independently of another assembly.**

Associated Masterformat Sections: 07 20 00 / 07 26 00 / 07 62 00 / 07 65 00 / 07 71 13  
07 71 16 / 07 71 19 / 07 71 29 / 09 28 00

## Uniformat Omniclass

### B3060 21-02 30 60 Horizontal Openings

*Includes: Openings in horizontal enclosures including roofing and traffic bearing horizontal enclosures. Includes Horizontal Opening Supplementary Components as appropriate.*

Associated Masterformat Sections:

100	See <a href="#">B30</a>	
200	See <a href="#">B2020</a>	

#### B3060.10 21-02 30 60 10 Roof Windows and Skylights

*Includes: Operable and non-operable roof windows. Includes: Skylights without framing with plastic and glass glazing. Includes: Skylights with framing.*

Associated Masterformat Sections: 01 83 16 / 08 60 00 / 08 61 00 / 08 62 00 / 08 63 00  
08 64 00 / 08 67 00

[See [B2020.10](#)]

#### B3060.50 21-02 30 60 50 Vents and Hatches

*Includes: Other roof openings such as roof hatches, smoke vents, and gravity roof ventilators.*

Associated Masterformat Sections: 07 72 33 / 07 72 36

[See [B3020.10](#)]

#### B3060.90 21-02 30 60 90 Horizontal Opening Supplementary Components

*Includes: Frames, hardware, glazing, flashing, and joint sealants to be included with horizontal opening elements above as appropriate.*

**These components are typically modeled as part of other assemblies listed in the tables above. Do not assign this Uniformat classification unless a supplementary component is modeled independently of another assembly.**

Associated Masterformat Sections: 08 75 00 / 08 80 00 / 07 60 00 / 07 92 00

### B3080 21-02 30 80 Overhead Exterior Enclosures

*Includes: Exposed to weather construction under horizontal enclosure construction. Includes suspension and support systems, insulation, vapor retarders, and air barriers.*

Associated Masterformat Sections: 01 83 16

100	See <a href="#">B30</a>	
200	Generic assemblies indicative of overall scope and approximate thickness/system depth of overhead enclosure.	

#### B3080.10 21-02 30 80 10 Exterior Ceilings

Associated Masterformat Sections: 07 42 00 / 07 44 00 / 09 20 00 / 09 54 00 / 09 56 00  
09 90 00

100	See <a href="#">B30</a>	
200	See <a href="#">B3080</a>	

## Uniformat Omniclass

300	Overall assembly modeled to specific system thickness including structural backing. Location of expansion or control joints indicated, but not modeled.	
350	Face material modeled to specific thickness. Structural backing members including bracing/lateral framing/kickers are modeled. Expansion or control joints are modeled to indicate specific width.	
400	Individual elements of face material are modeled. Structural backing members and all support members (kickers) are modeled including all connections. Expansion or control joints are modeled.	

### B3080.20 21-02 30 80 20 Exterior Soffits

Associated Masterformat Sections: 07 42 93 / 07 44 00 / 08 95 13 / 09 20 00 / 09 54 00  
09 56 00 / 09 90 00

[See [B3080.10](#)]

### B3080.30 21-02 30 80 30 Exterior Bulkheads

Associated Masterformat Sections: 07 42 00 / 07 44 00 / 09 20 00 / 09 54 00 / 09 56 00  
09 90 00

[See [B3080.10](#)]

## Unifomat Omniclass

### C 21-03 INTERIORS

Associated Masterformat Sections: 01 84 00

#### C10 21-03 10 Interior Construction

Associated Masterformat Sections: 01 84 13

100	A schematic model element or symbol that is not distinguishable by type or material.  Types, layouts, and locations are still flexible.	
-----	---	--

#### C1010 21-03 10 10 Interior Partitions

*Includes: Enclosures and partitions which are fixed and secured in place. Includes walls of concrete; and masonry; and wood and metal stud partitions with associated wall surfaces. Includes partitions of an open nature, such as wire mesh partitions. Partitions may be load bearing or non-load bearing. Includes Interior Partition Supplementary Components as appropriate.*

Associated Masterformat Sections: 10 22 00 / 01 84 13

100	See <a href="#">C10</a>	
200	Generic wall objects separated by type of material (e.g. gypsum board vs. masonry).  Approximate overall wall thickness represented by a single assembly.  Layouts, locations, heights, and elevation profiles are still flexible.	

#### C1010.10 21-03 10 10 10 Interior Fixed Partitions

*Includes: Enclosures and partitions which are fixed and secured in place. Includes walls of concrete; and masonry; and wood and metal stud partitions with associated wall surfaces. Includes partitions of an open nature, such as wire mesh partitions. Partitions may be load bearing or non-load bearing. Includes Interior Partition Supplementary Components as appropriate.*

Associated Masterformat Sections: 03 30 00 / 03 40 00 / 04 20 00 / 05 41 00 / 06 11 00 / 09 20 00 / 10 22 13

100	See <a href="#">C10</a>	
200	See <a href="#">C1010</a>	
300	Composite model assembly by type with overall thickness that accounts for framing and finish specified for the wall system. (Refer to LOD350 and LOD400 for individually modeled elements)  Wall elements are modeled to specific layouts, locations, heights, and elevation profiles. Penetrations are modeled to nominal dimensions for major wall openings such as windows, doors, and large mechanical elements.	
350	Structure and finish layers of partition assembly modeled as separate elements.	

## Unifomat Omniclass

	<p>All penetrations are modeled at actual rough-opening dimensions.</p> <p>Major framing elements such as king studs, kickers, diagonal bracing, and headers are modeled.</p>	
400	<p>Element modeling to include:</p> <ul style="list-style-type: none"> <li>• Studs and tracks</li> <li>• Bracing</li> <li>• Insulation</li> <li>• Sheathing or wall boards</li> <li>• Openings/penetrations</li> </ul>	

### C1010.10.10 21-03 10 10 10 10 Interior Wall (Masonry)

*Includes: Enclosures and partitions which are fixed and secured in place. Includes walls of concrete; and masonry; and wood and metal stud partitions with associated wall surfaces. Includes partitions of an open nature, such as wire mesh partitions. Partitions may be load bearing or non-load bearing. Includes Interior Partition Supplementary Components as appropriate.*

Associated Masterformat Sections: 10 22 00 / 01 84 13

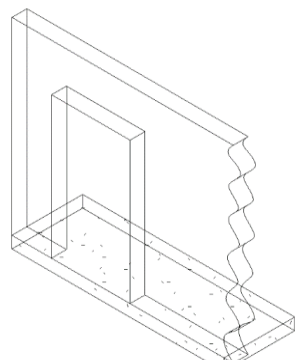
100	See <a href="#">C10</a>	
200	See <a href="#">C1010</a>	 <p>99 C1010.04-LOD-200 Interior Wall (Masonry)</p>

# Unifomat Omniclass

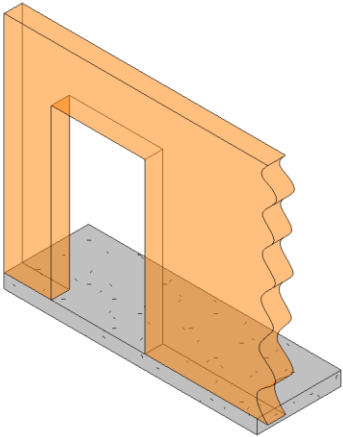
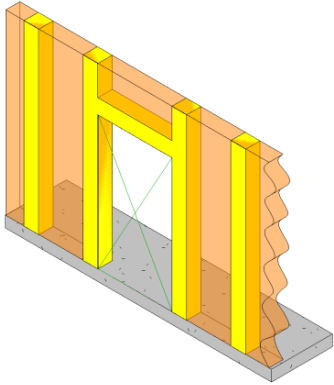
<p>300</p>	<p>See <a href="#">C1010.10</a></p>	 <p>100 C1010.04-LOD-300 Interior Wall (Masonry)</p>
<p>350</p>	<p>Element modeling to include:</p> <ul style="list-style-type: none"> <li>• Members modeled at any interface with wall edges (top, bottom, sides) or opening through wall</li> <li>• All penetrations are modeled at actual rough-opening dimensions.</li> <li>• Any regions that would impact coordination with other systems such as but not limited to:             <ul style="list-style-type: none"> <li>○ Bond Beam &amp; Lintel Regions</li> <li>○ Reinforcing &amp; Embed Regions</li> <li>○ Jam Regions</li> </ul> </li> </ul>	 <p>101 C1010.04-LOD-350 Interior Wall (Masonry)</p>

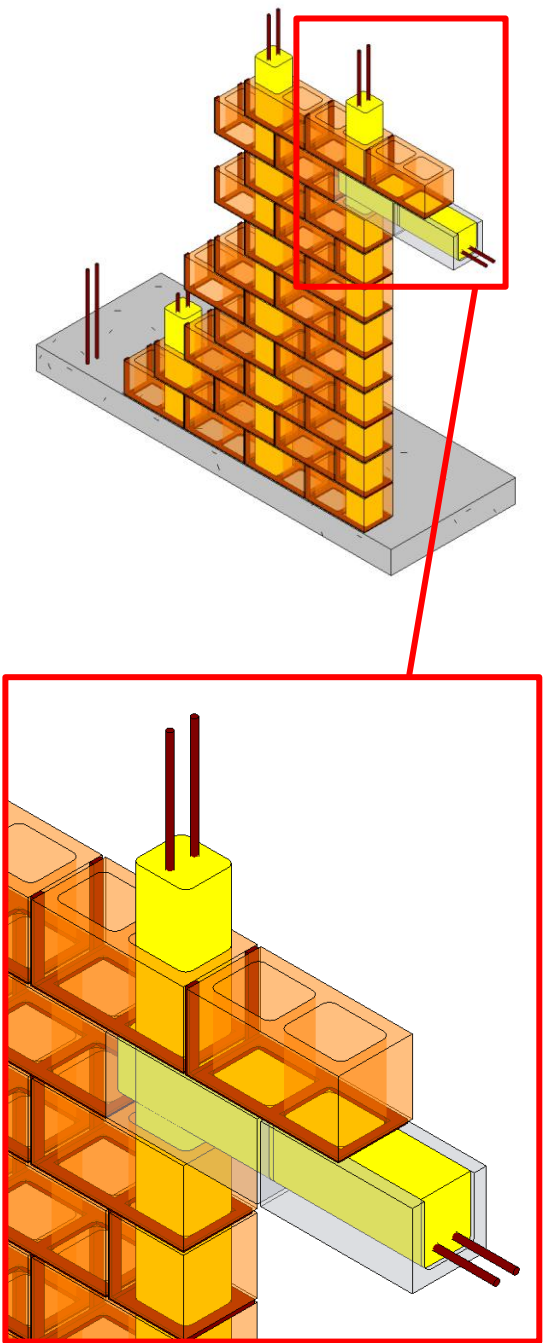

# Unifomat Omniclass

400	<p>Element modeling to include:</p> <ul style="list-style-type: none"><li>• Reinforcing</li><li>• Connections</li><li>• Grouting Material</li><li>• Jams</li><li>• Bond Beams</li><li>• Lintels</li><li>• Member fabrication part number</li><li>• Any part required for complete installation</li></ul>	 <p>102 C1010.04-LOD-400 Interior Wall (Masonry)</p>
-----	--	---

## Uniformat    Omniclass

### C1010.10.20    21-03 10 10 10 20    Interior Wall (Cold-Form Metal Framing)

*Includes: Enclosures and partitions which are fixed and secured in place. Includes walls of concrete; and masonry; and wood and metal stud partitions with associated wall surfaces. Includes partitions of an open nature, such as wire mesh partitions. Partitions may be load bearing or non-load bearing. Includes Interior Partition Supplementary Components as appropriate.*

Associated Masterformat Sections: 10 22 00 / 01 84 13

100	See <a href="#">C10</a>	
-----	-------------------------	--

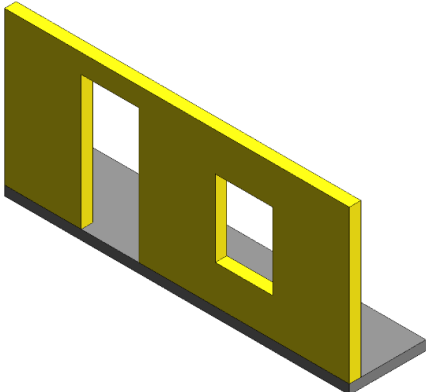
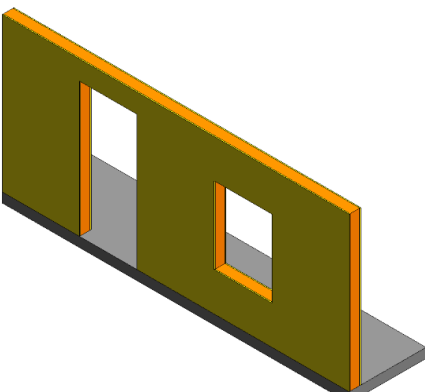

# Uniformat Omniclass

200	See <a href="#">C1010</a>	 <p>103 C1010.05-LOD-200 Interior Wall (Cold-Form Metal Framing)</p>
300	See <a href="#">C1010.10</a> <a href="#">C1010.10</a>	 <p>104 C1010.05-LOD-300 Interior Wall (Cold-Form Metal Framing)</p>

## Unifomat Omniclass

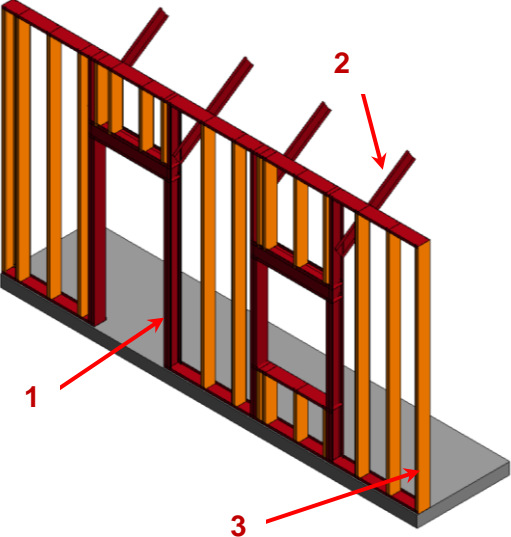
<p>350</p>	<p>Cold formed metal framing is developed with sufficient elements to support detailed interface coordination with other systems such as MEP.</p> <p>All penetrations are modeled at actual rough-opening dimensions.</p> <p><i>Image notes:</i></p> <ul style="list-style-type: none"><li>• <i>Elements in red are critical wall support elements that cannot be easily cut for coordination of MEP opening through the walls.</i></li><li>• <i>Diagonal bracing (kickers) that may be in the above ceiling space are modeled for coordination with other building content such as MEP passing along the wall in the above ceiling spaces.</i></li><li>• <i>Infill CFMF modeling (Orange) may be omitted at this LOD if stated in the BXP.</i></li><li>• <i>Cladding and sheathing are not shown for clarity in this image.</i></li></ul>	 <p>105 C1010.05-LOD-350 Interior Wall (Cold-Form Metal Framing)</p>
------------	--	--

# Unifomat Omniclass

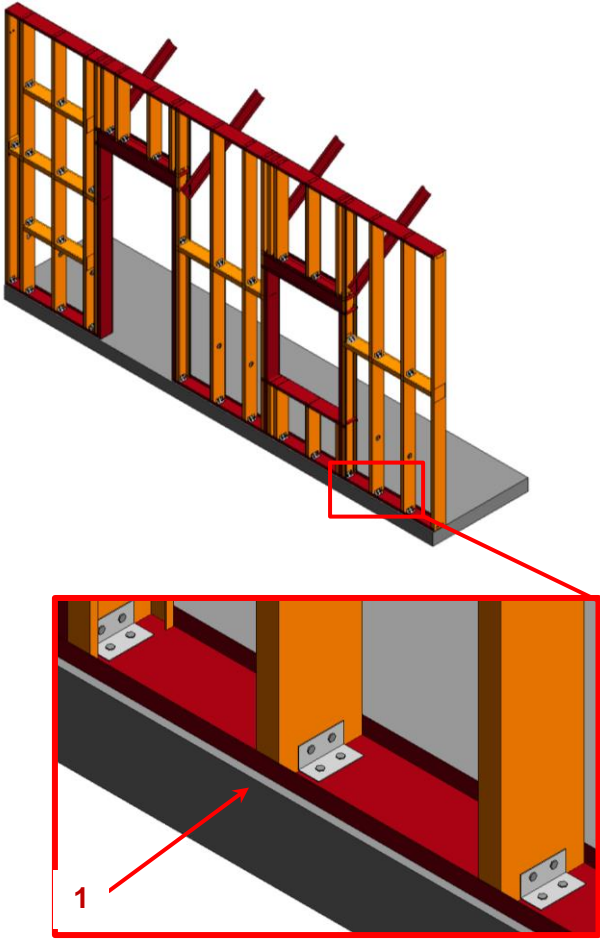
<p>400</p>	<p>Cold formed metal framing is developed with sufficient elements that support the fabrication of the CFMF system.</p> <p><i>Image notes:</i></p> <ol style="list-style-type: none"> <li>1) Connection content is development in the wall elements. This includes but is not limited to fasteners, clips, and other related hardware.</li> <li>2) Cladding and sheathing are not shown for clarity in this image.</li> </ol>	 <p>106 C1010.05-LOD-400 Interior Wall (Cold-Form Metal Framing)</p>
------------	---	---

## C1010.10.30 21-03 10 10 10 30 Interior Wall (Wood)

*Includes: Enclosures and partitions which are fixed and secured in place. Includes walls of concrete; and masonry; and wood and metal stud partitions with associated wall surfaces. Includes partitions of an open nature, such as wire mesh partitions. Partitions may be load bearing or non-load bearing. Includes Interior Partition Supplementary Components as appropriate.*

Associated Masterformat Sections: 10 22 00 / 01 84 13

<p>100</p>	<p>See <a href="#">C10</a></p>	
------------	--------------------------------	--

# Unifomat Omniclass

200	See <a href="#">C1010</a>	 <p>107 C1010.06-LOD-200 Interior Wall (Wood)</p>
300	See <a href="#">C1010</a>	 <p>108 C1010.06-LOD-300 Interior Wall (Wood)</p>

# Uniformat Omniclass

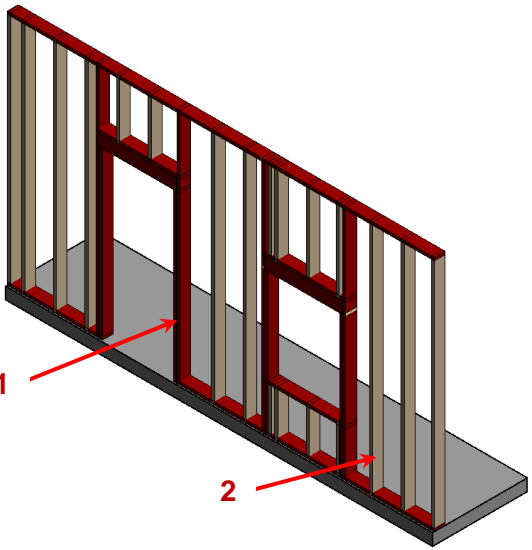
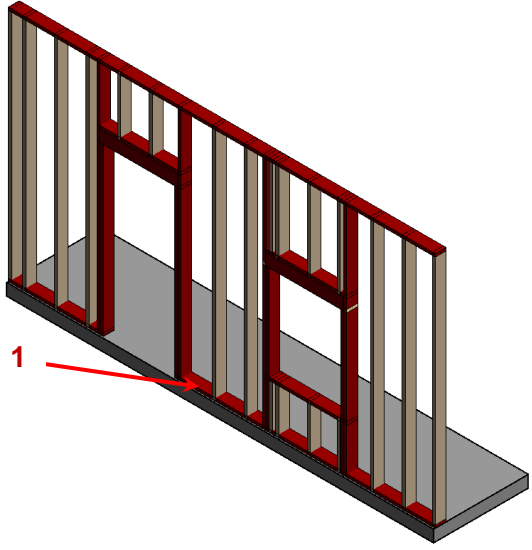
<p>350</p>	<p>Wood framing is developed with sufficient elements to support detailed interface coordination with other systems such as MEP.</p> <p>All penetrations are modeled at actual rough-opening dimensions.</p> <p><i>Image notes:</i></p> <ol style="list-style-type: none"><li>1) Elements in red are critical wall support elements that cannot be easily cut for coordination of MEP opening through the walls.</li><li>2) Infill wood framing modeling may be omitted at this LOD if stated in the BXP.</li><li>3) Cladding and sheathing are not shown for clarity in this image.</li></ol>	 <p>109 C1010.06-LOD-350 Interior Wall (Wood)</p>
<p>400</p>	<p>Wood framing is developed with sufficient elements that support the fabrication of the wood framing system.</p> <p>Openings and penetrations through studs are modeled.</p> <p><i>Image notes:</i></p> <ol style="list-style-type: none"><li>1) Connection content is development in the wall elements. This includes but is not limited to fasteners, anchor rods, and other related hardware.</li><li>2) Cladding and sheathing are not shown for clarity in this image.</li></ol>	 <p>110 C1010.06-LOD-400 Interior Wall (Wood)</p>

## Unifomat Omniclass

### C1010.20 21-03 10 10 20 Interior Glazed Partitions

*Includes: Partitions primarily composed of glazed elements that may be fabricated or field constructed. Includes Interior Partition Supplementary Components as appropriate.*

Associated Masterformat Sections: 08 43 00

100	See <a href="#">C10</a>	
200	See <a href="#">C1010</a>	
300	Specified location and orientation of face of glass. Nominal face dimensions and thickness of glazing. Structural support systems of wall to be modeled. Spacing, location, size and orientation of mullions. Operable components defined (doors) and included in model.	
350	<ul style="list-style-type: none"> <li>Mullion shapes and geometry defined.</li> <li>Actual anchorage layouts and types defined.</li> <li>Actual panel dimensions (including seating).</li> </ul>	
400	<ul style="list-style-type: none"> <li>Complete mullion extrusion profiles.</li> <li>Interface details between wall systems (within) and wall and support systems.</li> </ul>	

### C1010.40 21-03 10 10 40 Interior Demountable Partitions

Associated Masterformat Sections: 10 22 19 / 01 84 13 / 10 22 19.13 / 10 22 19.23 / 10 22 19.33  
10 22 19.43 / 10 22 19.53

100	See <a href="#">C10</a>	
200	See <a href="#">C1010</a>	
300	See <a href="#">C1010.10</a>	
350	See <a href="#">C1010.10</a> – also include hardware, accessories, and support structure.	
400	See <a href="#">C1010.10</a>	

### C1010.50 21-03 10 10 50 Interior Operable Partitions

*Includes: Track-supported, operable panels and partitions, top hung and floor supported, and manually and power operated. Includes auditorium partitions and dividers. Includes overhead supports.*

Associated Masterformat Sections: 01 84 13 / 01 84 13 / 10 22 33 / 10 22 36 / 10 22 39  
10 22 43

100	See <a href="#">C10</a>	
200	See <a href="#">C1010</a>	



## Uniformat Omniclass

300	Operable partition system modeled to include spatial requirements for open/storage position and closed position. Spatial requirements for structure (overhead or below) to be modeled.	
350	Major support elements (overhead or below) Mechanical connections	
400	All assembly components including tracks, panels, hardware and supports.	

### C1010.70 21-03 10 10 70 Interior Screens

*Portable and open dividers.*

Associated Masterformat Sections: 10 22 23 / 10 82 23

[See [C1010.10](#)]

### C1010.90 21-03 10 10 90 Interior Partitions Supplementary Components

*Sound isolation components, firestopping, and expansion control to be included with interior partition elements above as appropriate.*

**These components are typically modeled as part of other assemblies listed in the tables above. Do not assign this Uniformat classification unless a supplementary component is modeled independently of another assembly.**

Associated Masterformat Sections: 13 48 00 / 09 81 00 / 07 84 00 / 07 95 00

### C1020 21-03 10 20 Interior Windows

*Includes: Interior fixed or operable windows used singly and in multiples. Includes Interior Window Supplementary Components as appropriate. Includes metal, wood, plastic, and composite window units.*

Associated Masterformat Sections: 08 50 00 / 01 84 13

100	See <a href="#">C10</a>	
200	Windows approximate in terms of location, size, count and type. Units are modeled as a simple, monolithic component; or represented with simplified frame and glazing.  Nominal unit size is provided.	

### C1020.10 21-03 10 20 10 Interior Operating Windows

*Includes: Interior fixed or operable windows used singly and in multiples. Includes Interior Window Supplementary Components as appropriate. Includes metal, wood, plastic, and composite window units.*

Associated Masterformat Sections: 08 50 00

100	See <a href="#">C10</a>	
200	See <a href="#">C1020</a>	

## Uniformat Omniclass

300	<p>Units are modeled based on specified location and nominal size. Outer geometry of window frame elements and glazing modeled.</p> <p>Operation is indicated.</p> <p>Non-graphic information associated with model element:</p> <p>Aesthetic characteristics (finishes, glass types) Performance characteristics (i.e. U-value, wind loading, blast resistance, structural, air, thermal, water, sound) Functionality of the window (fixed, casement, double/single hung, awning/project out, pivot, sliding)</p>	
350	<p>Attachment method of window to structure</p> <p>Embed geometry</p>	
400	<p>Frame profiles</p> <p>Glazing sub-components (gaskets)</p> <p>Attachment components</p>	

### C1020.20 21-03 10 20 20 Interior Fixed Windows

*Includes: Interior fixed or operable windows used singly and in multiples. Includes Interior Window Supplementary Components as appropriate. Includes metal, wood, plastic, and composite window units.*

Associated Masterformat Sections: 08 50 00

### C1020.50 21-03 10 20 50 Interior Special Function Windows

*Includes interior windows with special characteristics for a special function.*

Associated Masterformat Sections: 08 56 00 / 08 56 19 / 08 56 46 / 08 56 49 / 08 88 49 / 08 56 53 / 08 88 53 / 08 88 56 / 08 56 63 / 08 56 73

### C1020.90 21-03 10 20 90 Interior Window Supplementary Components

*Includes: Frames, sills, operating hardware, glazing to be included with interior window elements above as appropriate.*

**These components are typically modeled as part of other assemblies listed in the tables above. Do not assign this Uniformat classification unless a supplementary component is modeled independently of another assembly.**

Associated Masterformat Sections: 08 75 00 / 08 80 00

### C1030 21-03 10 30 Interior Doors

*Includes: Interior door assemblies. Includes metal doors and frames, wood doors and frames, plastic doors, and composite doors. Includes Interior Door Supplementary Components as appropriate.*

Associated Masterformat Sections: 08 10 00 / 01 84 13

100	See <a href="#">C10</a>	
200	<p>Units are modeled as a simple, monolithic component; or represented with simple frame and panel.</p> <p>Nominal unit size is provided.</p>	

## Uniformat Omniclass

### C1030.10 21-03 10 30 10 Interior Swinging Doors

*Includes: Interior door assemblies. Includes metal doors and frames, wood doors and frames, plastic doors, and composite doors. Includes Interior Door Supplementary Components as appropriate.*

Associated Masterformat Sections: 08 10 00

100	See <a href="#">C10</a>	
200	See <a href="#">C1030</a>	
300	Door assemblies modeled by type to include the following: <ul style="list-style-type: none"> <li>• Specific door panels and frames (if applicable).</li> <li>• Operation is specified</li> </ul>	
350	Major framing elements are modeled at jambs and head in containing wall.  Operation or mechanism enclosures are modeled, if applicable.	
400	Actual frame/mullion extrusions.  Actual panel size dimensions.  All connections and interfaces modeled including brackets, supports, sealants, and thresholds.	

### C1030.20 21-03 10 30 20 Interior Entrance Doors

*Includes: Exterior personnel door assemblies at interior main entrances. Includes automatic, revolving, balanced, and other special operating entrance doors, and sliding storefront wall systems. Includes Interior Door Supplementary Components as appropriate when not part of storefront system.*

Associated Masterformat Sections: 08 42 00 / 08 42 26 / 08 42 29 / 08 42 33 / 08 42 36  
08 43 29

[See [B2050.10](#)]

### C1030.25 21-03 10 30 25 Interior Sliding Doors

Associated Masterformat Sections: 08 11 73 / 08 32 00

[See [C1030.10](#)]

### C1030.30 21-03 10 30 30 Interior Folding Doors

Associated Masterformat Sections: 08 35 13

[See [C1030.10](#)]

### C1030.40 21-03 10 30 40 Interior Coiling Doors

Associated Masterformat Sections: 08 33 00 / 08 33 13

100	See <a href="#">C10</a>	
200	See <a href="#">C1030</a>	
300	Coiling door assemblies modeled by type to include the following: <ul style="list-style-type: none"> <li>• Door panels with nominal dimensions.</li> </ul>	

## Uniformat Omniclass

	<ul style="list-style-type: none"> <li>• Frames with nominal dimensions.</li> <li>• Hardware set functionality and types included in non-graphic information.</li> <li>• Clearance zones for operation of overhead doors are modeled or accommodated by model checking software.</li> <li>• Enclosures and motor housings are modeled with overall nominal dimensions.</li> </ul>	
350	<p>Major framing elements in wall are modeled at jambs and head.</p> <p>Other major structural support elements are modeled.</p>	
400	All connections and interfaces modeled including brackets, supports, sealants, and thresholds.	

### C1030.50 21-03 10 30 50 Interior Panel Doors

*Includes: Interior large opening doors constructed of panels that move.*

Associated Masterformat Sections: 08 36 00 / 08 36 13 / 08 36 16 / 08 36 19 / 08 36 23

[See [C1030.40](#)]

### C1030.70 21-03 10 30 70 Interior Special Function Doors

*Includes: Interior door assemblies for a variety of special functions and applications involving a variety of operating methods. Includes Interior Door Supplementary Components as appropriate.*

Associated Masterformat Sections: 08 30 00. / 08 34 13 / 08 34 19 / 08 34 33 / 08 34 36  
08 34 46 / 08 34 49 / 08 88 49 / 08 34 53 / 08 42 33.13 / 08 88 53 / 08 88 56 / 08 34 59  
08 34 63 / 08 34 73 / 08 38 00 / 08 39 00

[See [C1030.40](#)]

### C1030.80 21-03 10 30 80 Interior Access Doors and Panels

*Includes: Doors and panels in walls, ceilings, and floors to provide access to concealed spaces. Includes frames and hardware.*

Associated Masterformat Sections: 08 31 00

[See [C1030.40](#)]

### C1030.90 21-03 10 30 90 Interior Door Supplementary Components

*Includes: Frames, hardware, glazing, and louvers that are part of door to be included with interior door elements above as appropriate.*

**These components are typically modeled as part of other assemblies listed in the tables above. Do not assign this Uniformat classification unless a supplementary component is modeled independently of another assembly.**

Associated Masterformat Sections: 08 10 00 / 08 30 00 / 08 71 00 / 08 80 00 / 08 91 26

## Unifomat Omniclass

### C1040 21-03 10 40 Interior Grilles and Gates

Includes: Interior operable grilles and gates Includes frames and hardware.

100	See <a href="#">C10</a>	
200	See <a href="#">C1030</a>	

### C1040.10 21-03 10 40 10 Interior Grilles

Associated Masterformat Sections: 08 11 74 / 08 33 00 / 08 35 16

100	See <a href="#">C10</a>	
200	See <a href="#">C1030</a>	
300	Grille assemblies modeled by type to include the following: <ul style="list-style-type: none"> <li>Nominal size of unit.</li> <li>Required openness provided as non-graphic information.</li> <li>Operation is specified graphically.</li> </ul>	
350	Major framing elements are modeled at jambs and head.	
400	All connections and interfaces modeled including brackets, supports, sealants, and thresholds.	

### C1040.50 21-03 10 40 50 Interior Gates

Includes: Interior devices of solid or open construction, usually hinged, to provide moveable barrier for access through partition or other divider. Includes hardware, accessories, and finishing.

Associated Masterformat Sections: 08 34 56 / 10 22 16

[See [C1040.10](#)]

### C1060 21-03 10 60 Raised Floor Construction

Associated Masterformat Sections: 01 84 13 / 01 84 13 / 01 84 13 / 01 84 13 / 01 84 13  
01 84 13 / 01 84 13 / 01 84 13 / 01 84 13

100	See <a href="#">C10</a>	
200	Generic assembly that contains spatial allowance for support system and flooring material.	

### C1060.10 21-03 10 60 10 Access Flooring

Includes: Free-standing, elevated accessible floor assembly forming an underfloor cavity that may be used for utility or other purposes.

Associated Masterformat Sections: 09 69 00

## Uniformat Omniclass

100	See <a href="#">C10</a>	
200	See <a href="#">C1060</a>	
300	Overall flooring assembly modeled by type to specified thickness/depth. Major openings such as shafts are modeled.	
350	Individual layers of assembly are modeled separately. All openings and penetrations are modeled. Expansion joints are modeled indicating specific width. Pedestals are modeled and located properly, if applicable.	
400	All assembly components are modeled including frame, floor tiles, pedestals, and cross bracing.	

### C1060.30      21-03 10 60 30      Platform/Stage Floors

Includes: Fixed construction of raised floor for platforms or stages.  
[See [C1060.10](#)]

### C1070      21-03 10 70      Suspended Ceiling Construction

*Includes: Ceiling Suspension Components.*

Associated Masterformat Sections: 01 84 13 / 01 84 13

100	Ceiling construction is represented in other composite objects such as floors or rooms; or, schematic model elements that are not distinguishable by type or material. Assembly depth/thickness and locations still flexible.	
200	Generic assemblies indicative of overall scope and approximate thickness/system depth of suspended ceiling.	

### C1070.10      21-03 10 70 10      Acoustical Suspended Ceilings

*Includes: Suspended tiles and panels with specific characteristics for acoustical purposes.*

Associated Masterformat Sections: 09 51 00 / 09 81 00

100	See <a href="#">C1070</a>	
200	See <a href="#">C1070</a>	
300	Overall assembly modeled to specific system thickness including structural backing. Location of expansion or control joints indicated, but not modeled.	

## Uniformat Omniclass

	Ceiling grid is shown as linework.	
350	Ceiling suspension grid is modeled. Structural backing members including bracing/lateral framing/kickers are modeled. Expansion or control joints are modeled to indicate specific width.	
400	All assembly components are modeled including tees, hangers, support structure, and tiles.	

### C1070.20 21-03 10 70 20 Suspended Plaster and Gypsum Board Ceilings

*Includes: Suspended assemblies with plaster and gypsum board surfaces.*

Associated Masterformat Sections: 09 20 00 / 09 22 26 / 09 81 00

100	See <a href="#">C1070</a>	
200	See <a href="#">C1070</a>	
300	Overall assembly modeled to specific system thickness including framing. Bulkheads Major penetrations are modeled.	
350	Major bracing elements such as kickers are modeled.	
400	All assembly components including furring channels, hangers, lath, plaster coats, and gypsum boards.	

### C1070.50 21-03 10 70 50 Specialty Suspended Ceilings

*Includes: Suspended specialty ceiling panels, units, and materials manufactured as finished*

Associated Masterformat Sections: 09 54 00 / 09 56 00

[See [C1070.10](#) or [C1070.20](#)]

### C1070.70 21-03 10 70 70 Special Function Suspended Ceilings

*Includes: Suspended ceiling assemblies with an additional special function including integrated ceiling assemblies.*

Associated Masterformat Sections: 09 57 00 / 09 57 53 / 09 58 00

[See [C1070.10](#) or [C1070.20](#)]

### C1070.90 21-03 10 70 90 Ceiling Suspension Components

*Includes: Hangers and framing to suspend ceiling and sound isolation components to be included with suspended ceiling construction elements above as appropriate.*

**These components are typically modeled as part of other assemblies listed in the tables above. Do not assign this Uniformat classification unless a supplementary component is modeled independently of another assembly.**

Associated Masterformat Sections: 13 48 00

[Back to TOC](#)



Copyright © 2017 by BIMForum. All rights reserved

This document is copyrighted under a [Creative Commons Attribution-NonCommercial-NoDerivatives 4.0 International License](#).

## Uniformat Omniclass

### C1090 21-03 10 90 Interior Specialties

100	See <a href="#">C10</a>	
200	Generic model elements with approximate nominal size. Placement and quantity remains flexible.	

### C1090.10 21-03 10 90 10 Interior Railings and Handrails

*Includes: Complete interior railing assemblies of various types including glazed railings.*

Associated Masterformat Sections: 01 84 00 / 01 84 00 / 01 84 00 / 01 84 00 / 05 52 00  
05 73 00 / 06 43 16 / 06 63 00 / 06 81 00

100	See <a href="#">C10</a>	
200	Generic model element representing approximate overall height and location of railing/handrail.	
300	Railing/handrail systems modeled by type to include: <ul style="list-style-type: none"> <li>All horizontal rails</li> <li>All vertical posts/balusters</li> </ul>	
350	Mounting/attachment components	
400	All assembly components including fasteners and supports.	

### C1090.15 21-03 10 90 15 Interior Louvers

*Includes: Interior louvers, and other items for ventilation which are not an integral part of the mechanical system. Includes operable and stationary louvers.*

Associated Masterformat Sections: 08 91 00 / 01 84 00

100	See <a href="#">C10</a>	
200	Generic model element that is indicative of approximate area and location of louver.	
300	Louver assembly modeled by type, indicative of area and location of intended louver/vent. Accurate frame and blade boundary areas Opening for louver is cut from host wall.	
350	Rough opening is modeled in containing wall. Major framing elements are modeled at jambs and head. Connection points are modeled.	
400	All connections and interfaces modeled including brackets, supports, and sealants.	



## Uniformat Omniclass

### C1090.20 21-03 10 90 20 Information Specialties

*Includes: Visual display units, display cases, directories, interior signage, telephone specialties, and informational kiosks.*

Associated Masterformat Sections: 10 10 00 / 10 11 00 / 10 11 13 / 10 11 16 / 10 11 23  
10 11 33 / 10 11 36 / 10 11 39 / 10 11 43 / 10 11 46 / 10 12 00 / 10 13 00 / 10 14 00 / 10 17 00 / 10 18 00

[See [Fundamental LOD Definitions](#)]

### C1090.25 21-03 10 90 25 Compartments and Cubicles

*Includes: Manufactured compartments and cubicles for specific purposes. Includes toilet compartments, shower stalls, etc.*

Associated Masterformat Sections: 10 21 00 / 10 21 13 / 10 21 16 / 10 21 23 / 10 28 19

[See [Fundamental LOD Definitions](#)]

### C1090.30 21-03 10 90 30 Service Walls

*Includes: Wall assemblies and wall-mounted units incorporating services.*

Associated Masterformat Sections: 10 25 00 / 10 25 13 / 10 25 16

[See [C1010.10](#)]

### C1090.35 21-03 10 90 35 Wall and Door Protection

*Includes: Manufactured protective devices for walls and doors. Includes corner guards, bumper guards, and protective wall covering.*

Associated Masterformat Sections: 10 26 00 / 10 26 13 / 10 26 16 / 10 26 23 / 10 26 33

[See [Fundamental LOD Definitions](#)]

### C1090.40 21-03 10 90 40 Toilet, Bath and Laundry Accessories

*Includes: Manufactured items for use in conjunction with toilets, baths, and laundries.*

Associated Masterformat Sections: 10 28 00 / 10 28 13 / 10 28 16 / 10 28 23

[See [Fundamental LOD Definitions](#)]

### C1090.45 21-03 10 90 45 Interior Gas Lighting

Associated Masterformat Sections: 10 84 16

[See [Fundamental LOD Definitions](#)]

### C1090.50 21-03 10 90 50 Fireplaces and Stoves

*Includes: Masonry fireplaces and manufactured and fabricated fireplaces, stoves, chimneys, dampers, and specialties for use in construction of fireplaces and stove units.*

Associated Masterformat Sections: 10 30 00 / 04 50 00 / 04 57 00 / 10 31 00 / 10 31 13  
10 32 00 / 10 35 00

[See [Fundamental LOD Definitions](#)]

## Unifomat Omniclass

C1090.60 21-03 10 90 60 Safety Specialties

Includes: Accessories that provide emergency aid.  
Associated Masterformat Sections: 10 40 00 / 10 41 00 / 10 43 00

[See [Fundamental LOD Definitions](#)]

C1090.70 21-03 10 90 70 Storage Specialties

Includes: Lockers, postal specialties, storage specialties, and wardrobe and closet specialties.  
Associated Masterformat Sections: 10 50 00 / 10 51 00 / 10 51 53 / 10 55 00 / 10 55 23 / 10 55 91 / 10 56 00 / 10 56 29 / 10 56 33 / 10 57 00 / 10 57 13 / 10 57 33

[See [Fundamental LOD Definitions](#)]

C1090.90 21-03 10 90 90 Other Interior Specialties

Includes: Pest control devices, flags and banners, security mirrors and domes, and scales.  
Associated Masterformat Sections: 10 80 00 / 10 81 00 / 10 81 16 / 10 81 19 / 10 83 00 / 08 83 00 / 10 86 00 / 10 88 00

[See [Fundamental LOD Definitions](#)]

## C20 21-03 20 Interior Finishes

Associated Masterformat Sections: 01 84 19

100	Non-graphic information attached to model elements providing assumptions about proposed finish materials. See Part II	
-----	---	--

## C2010 21-03 20 10 Wall Finishes

Includes: Wall finishes applied over solid substrates. Includes Wall Finish Supplementary Components as appropriate.

Associated Masterformat Sections: 09 70 00 / 01 84 19 / 01 84 19 / 01 84 19 / 01 84 19 / 01 84

100	See <a href="#">C20</a>	
200	Generic materials other than sheet goods and coatings by type (e.g. tile or paneling), approximate thickness and scope in elevation.	
300	Materials are modeled based on specific types (e.g. Tile type CT-1). Thickness and scope of finishes other than sheet goods and coatings are accurately modeled.	

## Unifomat Omniclass

	Sheet goods and coatings may be specified in Part II related to interior partitions.	
350	Additional non-graphic information to include: <ul style="list-style-type: none"><li>• Manufacturer</li><li>• Model</li></ul>	
400	Pattern layouts Expansion/control joints Edges	

### C2010.10 21-03 20 10 10 Tile Wall Finish

*Includes: Manufactured surfacing units of impervious, vitreous, semi-vitreous, and non-vitreous materials; glazed, unglazed, conductive, and textured surfaces.*

Associated Masterformat Sections: 09 30 00

[See [C2010](#)]

### C2010.20 21-03 20 10 20 Wall Paneling

*Includes: Covering or cladding of interior walls with paneling. Includes associated furring, fastening, and trim.*

Associated Masterformat Sections: 06 42 00 / 06 25 00 / 06 26 00 / 06 64 00 / 06 83 00

[See [C2010](#)]

### C2010.30 21-03 20 10 30 Wall Coverings

*Includes: Wall coverings applied over solid substrates. Includes vinyl-coated fabric, vinyl and cork wall coverings; wall papers; and flexible wood sheets.*

Associated Masterformat Sections: 09 72 00 / 09 74 00

[See [C2010](#)]

### C2010.35 21-03 20 10 35 Wall Carpeting

*Includes: Wall carpet materials and accessories.*

Associated Masterformat Sections: 09 73 00

### C2010.50 21-03 20 10 50 Stone Facing

*Includes: Natural stone applied as an interior veneer surface.*

Associated Masterformat Sections: 09 75 00

[See [C2010](#)]

### C2010.60 21-03 20 10 60 Special Wall Surfacing

*Includes: Manufactured decorative interior wall surface products including plastic blocks.*

Associated Masterformat Sections: 09 77 00 / 09 77 13 / 09 77 23 / 09 76 00

[See [C2010](#)]

## Unifomat Omniclass

### C2010.70 21-03 20 10 70 Wall Painting and Coating

*Includes: Interior painting and coating with transparent and opaque finishes. Includes stains, varnishes, lacquers, primers, fillers, paint removers, and waxes, and preparation of surfaces.*

Associated Masterformat Sections: 09 90 00

[See [C2010](#)]

### C2010.80 21-03 20 10 80 Acoustical Wall Treatment

*Includes: Sound absorbing, reflecting, and diffusing wall units, and accessories.*

Associated Masterformat Sections: 09 83 13 / 09 84 00 / 09 84 33

[See [C2010](#)]

### C2010.90 21-03 20 10 90 Wall Finish Supplementary Components

*Includes: Furring to be included with wall finish elements above as appropriate.*

Associated Masterformat Sections: 06 10 00 / 09 22 13

[See [C1010](#)]

### C2020 21-03 20 20 Interior Fabrications

*Includes: Interior fabrications of a variety of materials formed to various profiles for a variety of purposes including column covers.*

Associated Masterformat Sections: 03 49 00 / 05 50 00 / 05 58 13 / 05 70 00 / 06 44 00 / 06 60 00 / 06 61 00 / 06 80 00 / 09 27 00

[See [Fundamental LOD Definitions](#)]

### C2030 21-03 20 30 Flooring

*Includes: Flooring Supplementary Components as appropriate.*

Associated Masterformat Sections: 09 60 00 / 01 84 19

[See [C2010](#)]

Unifomat	Omniclass		
C2030.10	21-03 20 30 10	Flooring Treatment	TBD
C2030.20	21-03 20 30 20	Tile Flooring	TBD
C2030.30	21-03 20 30 30	Specialty Flooring	TBD
C2030.40	21-03 20 30 40	Masonry Flooring	TBD
C2030.45	21-03 20 30 45	Wood Flooring	TBD
C2030.50	21-03 20 30 50	Resilient Flooring	TBD
C2030.60	21-03 20 30 60	Terrazzo Flooring	TBD
C2030.70	21-03 20 30 70	Fluid-Applied Flooring	TBD
C2030.75	21-03 20 30 75	Carpeting	TBD
C2030.80	21-03 20 30 80	Athletic Flooring	TBD
C2030.85	21-03 20 30 85	Entrance Flooring	TBD
C2030.90	21-03 20 30 90	Floor Supplementary Components	TBD

## C2040      21-03 20 40      Stair Finishes

*Includes: Stair tread, riser, and landing finish of various materials.*

Associated Masterformat Sections: 01 84 19

[See [C2010](#)]

Uniformat	Omniclass		
C2040.20	21-03 20 40 20	Tile Stair Finish	TBD
C2040.40	21-03 20 40 40	Masonry Stair Finish 09 63 00	TBD
C2040.45	21-03 20 40 45	Wood Stair Finish 09 64 00	TBD
C2040.50	21-03 20 40 50	Resilient Stair Finish 09 65 00	TBD
C2040.60	21-03 20 40 60	Terrazzo Stair Finish 09 66 00	TBD
C2040.75	21-03 20 40 75	Carpeted Stair Finish 09 68 00	TBD
<b>C2050</b>	<b>21-03 20 50</b>	<b>Ceiling Finishes</b>	
<i>Includes: Finishes applied to interior ceiling substrates. Ceiling finishes may be applied to suspended ceiling construction. Includes Ceiling Finish Supplementary Components as appropriate.</i>			
Associated Masterformat Sections: 09 50 00 / 01 84 19			
C2050.10	21-03 20 50 10	Plaster and Gypsum Board Finish	TBD
C2050.20	21-03 20 50 20	Ceiling Paneling	TBD
C2050.70	21-03 20 50 70	Ceiling Painting and Coating	TBD
C2050.80	21-03 20 50 80	Acoustical Ceiling Treatment	TBD
C2050.90	21-03 20 50 90	Ceiling Finish Supplementary Components	TBD

## Uniformat Omniclass

### **D**                      **21-04 00 00**                      **SERVICES**

Associated Masterformat Sections: 01 86 00

#### **D10**                      **21-04 10**                      **Conveying**

Associated Masterformat Sections: 01 85 00 / 14 00 00

100	Schematic model elements that are not distinguishable by type or material. Component sizes and locations still flexible.	
-----	---	--

#### **D1010**                      **21-04 10 10**                      **Vertical Conveying Systems**

Associated Masterformat Sections:

100	See <a href="#">D10</a>	
200	Generic representation of the system envelope, including critical path of travel zones.	

# Unifomat Omniclass

## D1010.10 21-04 10 10 10 Elevators

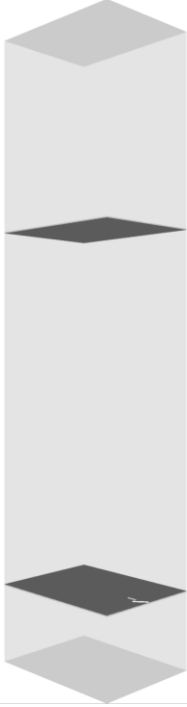
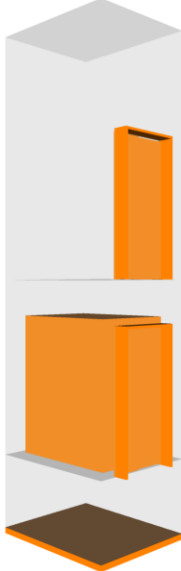

*Includes: Passenger and freight elevators of all types, including cars, enclosures, controls, safety equipment, hoist way equipment, and elevator machinery. Includes associated metal fabrications including pit ladders.*

Associated Masterformat Sections: 01 85 00 / 14 20 00 / 14 21 13 / 14 21 23 / 14 21 33 / 14 21 43 / 14 24 13 / 14 24 23 / 14 24 33 / 14 24 43 / 14 26 00 / 14 27 00 / 14 28 00

<p>100</p>	<p>See <a href="#">D10</a></p>	
<p>200</p>	<p>See <a href="#">D1010</a></p>	

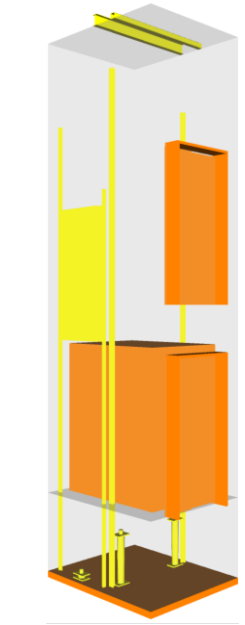

# Unifomat Omniclass

<p>300</p>	<p>Specific system elements modeled by type, including all path of travel zones.</p> <p>Pits and/or control rooms and associated equipment to be modeled if applicable.</p> <p>Major structural support elements modeled.</p> <p>Connections to mechanical or electrical services.</p>	
<p>350</p>	<p>Sizing adjusted to the actual manufacturer specifications.</p> <p>Guiding tracks/rails</p> <p>Service/access zones</p>	

## Unifomat Omniclass

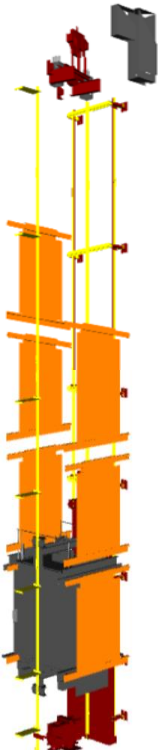
400	All connections, supports, framing, and other supplementary components.	
-----	---	--

### D1010.20 21-04 10 10 20 Lifts

*Includes: Vertical or inclined lifts and related equipment for a variety of purposes. Sidewalk lifts include doors.*

Associated Masterformat Sections: 01 85 00 / 14 40 00 / 14 41 00 / 14 42 00 / 14 43 00  
14 43 13 / 14 43 16 / 14 44 00 / 14 45 00

[See [D1010.10](#)]

### D1010.30 21-04 10 10 30 Escalators

*Includes: Passenger conveying systems composed of moving treads installed in inclined position including associated components, hardware, controls, safety equipment, and related items.*

Associated Masterformat Sections: 01 85 00 / 14 31 00

[See [D1010.10](#)]

### D1010.50 21-04 10 10 50 Dumbwaiters

*Includes: Packaged and field assembled, motorized and hand- operated dumbwaiters including associated components for book lifts, cart lifts, and other applications. Systems include associated components, hardware, controls, and safety equipment.*

Associated Masterformat Sections: 01 85 00 / 14 10 00

## Unifomat Omniclass

[See [D1010.10](#)]

### D1010.60 21-04 10 10 60 Moving Ramps

*Includes: Passenger conveying systems composed of moving belts installed in inclined position including associated components, hardware, controls, safety equipment, and related items.*

Associated Masterformat Sections: 01 85 00 / 14 33 00

[See [D1010.10](#)]

### D1030 21-04 10 30 Horizontal Conveying

Associated Masterformat Sections: 01 85 00

[See [D1010.10](#)]

### D1030.10 21-04 10 30 10 Moving Walks

*Includes: Passenger conveying systems composed of moving belts installed in horizontal position including associated components, hardware, controls, safety equipment, and related items.*

Associated Masterformat Sections: 01 85 00 / 14 32 00

[See [D1010.10](#)]

### D1030.30 21-04 10 30 30 Turntables

*Includes: Structural turntables for various applications.*

Associated Masterformat Sections: 01 85 00 / 14 70 00 / 14 71 00 / 14 71 11 / 14 72 00  
14 72 25 / 14 73 00 / 14 73 59 / 14 74 00 / 14 74 61

[See [D1010.10](#)]

### D1030.50 21-04 10 30 50 Passenger Loading Bridges

*Includes: Operating bridges for loading and unloading of passengers to and from aircraft and ships.*

Associated Masterformat Sections: 01 85 00 / 34 77 13

[See [D1010.10](#)]

### D1030.70 21-04 10 30 70 People Movers

*Includes: Single rail vehicles suspended from or straddle the guideway. Includes associated track, equipment, controls, and accessories. Includes: Steep cable railways in which ascending cars counterbalance descending cars. Includes associated track, cable. Includes: Steep slope transportation system utilizing moving cable. Includes associated cable, support structures, equipment, controls, and accessories.*

Associated Masterformat Sections: 01 85 00 / 34 12 00 / 34 13 00 / 34 14 00

[See [D1010.10](#)]

### D1050 21-04 10 50 Material Handling

Associated Masterformat Sections: 01 85 00

## Uniformat Omniclass

100	See <a href="#">D10</a>	
200	Generic representation of the material handling system envelope, including critical path of travel zones.	

### D1050.10 21-04 10 50 10 Cranes

*Includes: Hoisting towers, cranes, crane rails, and related accessories.*

Associated Masterformat Sections: 41 22 13

100	See <a href="#">D10</a>	
200	See <a href="#">D1050</a>	
300	Specific system elements modeled by type, including all path of travel/boom swing zones.  Lay-down/pick-up zones are modeled.  Major structural support elements modeled.  Connections to mechanical or electrical services.	
350	Sizing adjusted to the actual manufacturer specifications.  Guiding tracks/rails  Service/access zones	
400	All connections, supports, framing, and other supplementary components.	

### D1050.20 21-04 10 50 20 Hoists

*Includes: Manual and motor operated hoists and related accessories.*

Associated Masterformat Sections: 41 22 23

[See [D1050.10](#)]

### D1050.30 21-04 10 50 30 Derricks

*Includes: Manual and motor operated derricks and related accessories.*

Associated Masterformat Sections: 41 22 33

[See [D1050.10](#)]

### D1050.40 21-04 10 50 40 Conveyors

*Includes: Automatic guided vehicles, conveyors, diverters, and chutes. Includes controls and accessories.*

Associated Masterformat Sections: 41 21 00

[See [D1050.10](#)]

### D1050.50 21-04 10 50 50 Baggage Handling Equipment

*Includes: Operating equipment for handling, scanning, and weighing of baggage at terminals. Includes controls and accessories.*

# Unifomat Omniclass

Associated Masterformat Sections: 34 77 16

100	See <a href="#">D10</a>	
200	See <a href="#">D1050</a>	
300	See <a href="#">Fundamental LOD Definitions</a>	
350	See <a href="#">Fundamental LOD Definitions</a>	
400	See <a href="#">Fundamental LOD Definitions</a>	

## D1050.60 21-04 10 50 60 Chutes

*Includes: Chutes which support the operation of the building or structure.*

Associated Masterformat Sections: 14 91 00 / 14 91 13 / 14 91 23 / 14 91 33 / 14 91 82

[See [D1050.10](#)]

## D1050.70 21-04 10 50 70 Pneumatic Tube Systems

*Includes: Pneumatically operated tube system for the delivery of small items within a facility. Includes controls and accessories.*

Associated Masterformat Sections: 14 92 00

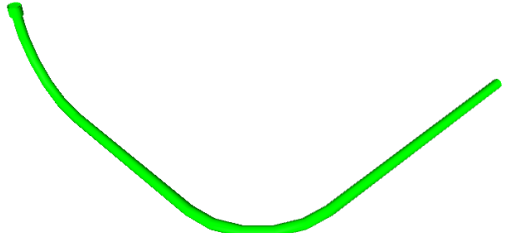
100	Diagrammatic elements or quantitative call outs; conceptual and/or schematic flow diagrams;	 <p>111 D1050.70-LOD-100 Pneumatic Tube Systems</p>
200	Generic elements; schematic layout with approximate size, shape, and location of equipment and tubing;	 <p>112 D1050.70-LOD-200 Pneumatic Tube Systems</p>

# Unifomat Omniclass

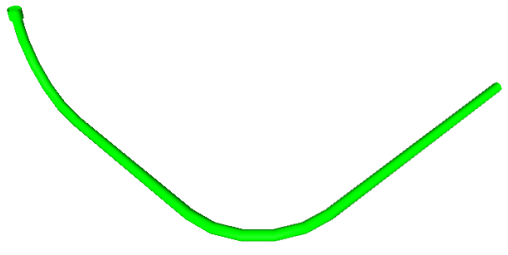
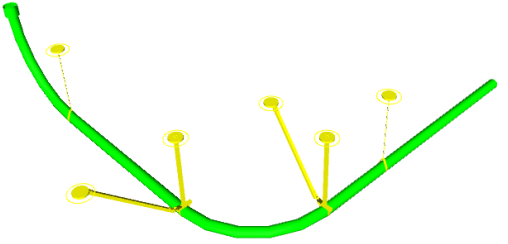
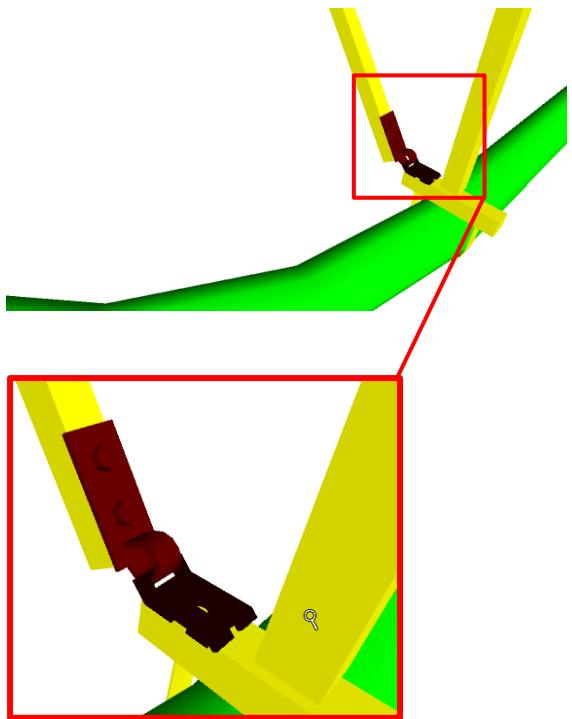
<p>300</p>	<p>Modeled as design-specified elements; specified size, shape, spacing, and location of equipment and tubing; approximate allowances for spacing and clearances required for all specified hangers, supports, vibration and seismic control that are to be utilized in the layout of all equipment and tubing are modeled or accommodated by model checking software; access/code clearance requirements modeled or accommodated by model checking software.</p>	 <p>113 D1050.70-LOD-300 Pneumatic Tube Systems</p>
<p>350</p>	<p>Modeled as <i>actual construction</i> elements; actual size, shape, spacing, and location/connections of equipment and tubing; actual size, shape, spacing, and clearances required for all hangers, supports, vibration and seismic control that are utilized in the layout of all equipment and tubing are or accommodated by model checking software; floor and wall penetrations modeled. actual access/code clearance requirements modeled or accommodated by model checking software.</p>	 <p>114 D1050.70-LOD-350 Pneumatic Tube Systems</p>
<p>400</p>	<p>Supplementary components added to the model required for fabrication and field installation</p>	 <p>115 D1050.70-LOD-400 Pneumatic Tube Systems</p>

## Unifomat Omniclass

### D1080 21-04 10 80 Operable Access Systems

Associated Masterformat Sections:

[See [Fundamental LOD Definitions](#)]

#### D1080.10 21-04 10 80 10 Suspended Scaffolding

*Includes: Suspended scaffolding when part of the completed project.*

Associated Masterformat Sections: 14 81 00

[See [Fundamental LOD Definitions](#)]

#### D1080.20 21-04 10 80 20 Rope Climbers

*Includes: Powered rope climbers to access exterior façade.*

Associated Masterformat Sections: 14 82 00

[See See [Fundamental LOD Definitions](#)]

#### D1080.30 21-04 10 80 30 Elevating Platforms

*Includes: Fixed elevating platforms to provide a movable elevated working platform for people and materials.*

Associated Masterformat Sections: 14 83 00

[See See [Fundamental LOD Definitions](#)]

#### D1080.40 21-04 10 80 40 Powered Scaffolding

*Includes: Powered scaffolding when part of the completed project.*

Associated Masterformat Sections: 14 84 00 / 14 84 13

[See [Fundamental LOD Definitions](#)]

#### D1080.50 21-04 10 80 50 Building Envelope Access

Associated Masterformat Sections: 11 24 23

[See [Fundamental LOD Definitions](#)]

### D20 21-04 20 Plumbing

Associated Masterformat Sections: 01 86 16 / 22 00 00

100	Diagrammatic or schematic model elements; conceptual and/or schematic layout/flow diagram; design performance parameters as defined in the BXP to be associated with model elements as non-graphic information.	
-----	---	--

### D2010 21-04 20 10 Domestic Water Distribution

*Includes: Facility domestic water distribution system. Include Domestic Water Distribution Supplementary Components as appropriate.*

Associated Masterformat Sections: 01 86 16 / 22 11 00

## Unifomat Omniclass

100	See <a href="#">D20</a>	
200	Schematic layout of generic model elements with approximate size, shape, and location of elements; shaft requirements modeled;	

### D2010.10 21-04 20 10 10 Facility Potable-Water Storage Tanks

*Includes: Tanks for storage of potable water serving a facility and located within, on, under, or closely associated with a structure.*

Associated Masterformat Sections: 22 12 00

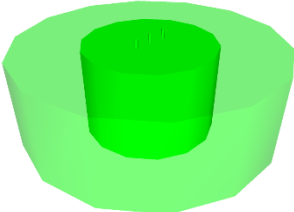
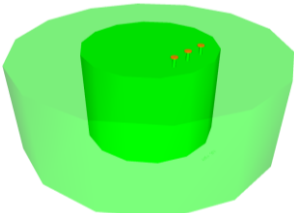
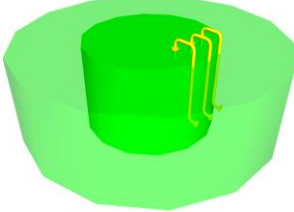
100	See <a href="#">D20</a>	
200	Schematic layout with approximate size, shape, and location of tank(s);	 <p>116 D2010.10-LOD-200 Facility Potable-Water Storage Tanks</p>
300	Modeled as design-specified size, shape, spacing, and location of tank(s); access/code clearance requirements and approximate allowances for spacing and clearances required for all specified anchors, supports, vibration and seismic control that are utilized in the layout of tanks(s) are modeled or accommodated by model checking software;	 <p>117 D2010.10-LOD-300 Facility Potable-Water Storage Tanks</p>
350	Modeled as actual construction elements <i>size and shape, spacing, and location/connections</i> of tank(s) actual access/code clearance requirements and actual size and shape, spacing, and clearances required for all specified anchors, supports, vibration and seismic control that are utilized in the layout of tanks(s) are modeled or accommodated by model checking software.	 <p>118 D2010.10-LOD-350 Facility Potable-Water Storage Tanks</p>



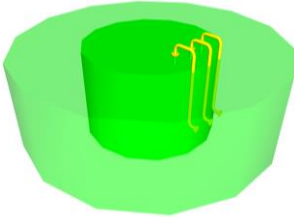

## Uniformat Omniclass

400	Supplementary components added to the model required for fabrication and field installation.	 <p>119 D2010.10-LOD-400 Facility Potable-Water Storage Tanks</p>
-----	--	--

### D2010.20 21-04 20 10 20 Domestic Water Equipment

*Includes: Equipment for domestic water distribution system. Includes: Equipment for the softening of domestic water. Includes: Equipment for the filtering of domestic water. Includes: Equipment to heat domestic water. Includes electric and fuel-fired equipment. Includes: Equipment to heat domestic water by means of heat exchange.*

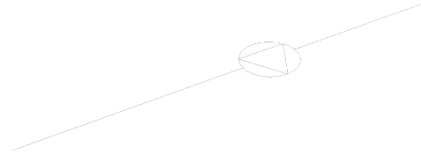
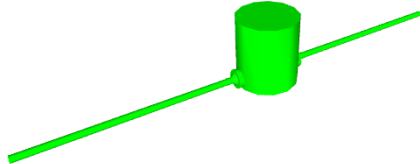
Associated Masterformat Sections: 22 11 23 / 22 31 00 / 22 32 00 / 22 33 00 / 22 34 00  
22 35 00

100	See <a href="#">D20</a>	 <p>120 D2010.20-LOD-100 Domestic Water Equipment</p>
200	Schematic layout with approximate size, shape, and location of equipment; approximate access/code clearance requirements modeled;	 <p>121 D2010.20-LOD-200 Domestic Water Equipment</p>
300	Modeled as design-specified size, shape, spacing, and location of equipment; approximate allowances for spacing and clearances required for all specified anchors, supports, vibration and seismic control that are utilized in the layout of equipment; access/code clearance requirements modeled.	 <p>122 D2010.20-LOD-300 Domestic Water Equipment</p>

## Unifomat Omniclass

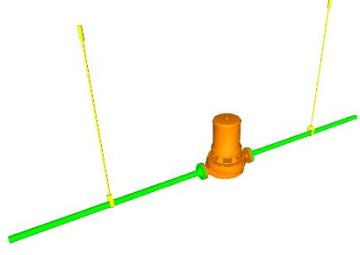
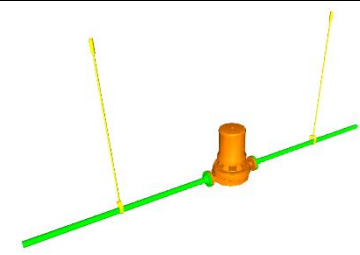
350	<p>Modeled as actual construction elements size, shape, spacing, and location/connections of equipment;</p> <p>Actual size, shape, spacing, and clearances required for all specified anchors, supports, vibration and seismic control that are utilized in the layout of equipment.</p> <p>actual access/code clearance requirements modeled.</p>	 <p>123 D2010.20-LOD-350 Domestic Water Equipment</p>
400	See <a href="#">D2010.10</a>	 <p>124 D2010.20-LOD-400 Domestic Water Equipment</p>

### D2010.40 21-04 20 10 40 Domestic Water Piping

*Includes: Piping, valves, and specialties associated with domestic water distribution located within, under, or closely associated with a structure. Includes circulating pumps. May Include: Water service from the structure to the utility water service line.*

Associated Masterformat Sections: 22 11 16 / 22 11 19

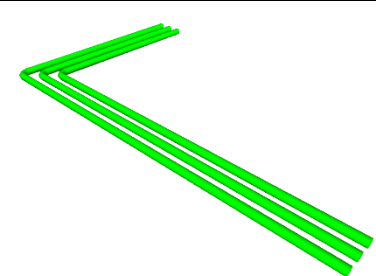
100	<p>Diagrammatic or schematic model elements;</p> <p>conceptual and/or schematic flow diagrams;</p> <p>design performance parameters as defined in the BXP to be associated with model elements as non-graphic information.</p>	
200	<p>Schematic layout with approximate size, shape, and location of mains and risers;</p> <p>shaft requirements modeled;</p>	 <p>125 D2010.40-LOD-200 Domestic Water Piping</p>

## Unifomat Omniclass

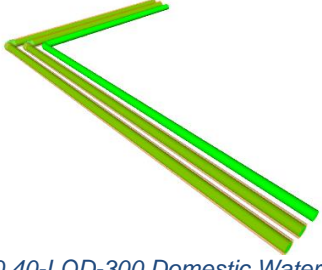
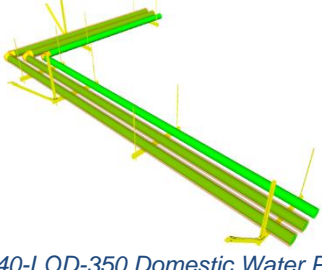
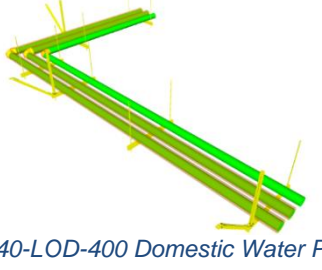
<p>300</p>	<p>Modeled as design-specified size, shape, spacing, and location of pipe, valves, fittings, and insulation for risers, mains, and branches;</p> <p>approximate allowances for spacing and clearances required for all specified hangers, supports, vibration and seismic control that are to be utilized in the layout of all risers, mains, and branches;</p> <p>access/code clearance requirements modeled.</p>	 <p>126 D2010.40-LOD-300 Domestic Water Piping</p>
<p>350</p>	<p>Modeled as actual construction elements;</p> <p>Actual size, shape, spacing, and location/connections of pipe, valves, fittings, and insulation for risers, mains, and branches;</p> <p>Actual size, shape, spacing, and clearances required for all hangers, supports, vibration and seismic control that are utilized in the layout of all risers, mains, and branches;</p> <p>Actual floor and wall penetration elements modeled.</p> <p>actual access/code clearance requirements modeled.</p>	 <p>127 D2010.40-LOD-350 Domestic Water Piping</p>
<p>400</p>	<p>See <a href="#">D2010.10</a></p>	 <p>128 D2010.40-LOD-400 Domestic Water Piping</p>



### D2010.60 21-04 20 10 60 Plumbing Fixtures

*Includes: Terminal devices on the domestic water plumbing system. Includes rough-in piping, trim, fittings, and connection to vent piping.*

Associated Masterformat Sections: 22 40 00 / 22 41 00 / 22 41 13 / 22 41 16 / 22 41 19  
 22 41 23 / 22 41 26 / 22 41 36 / 22 41 39 / 22 42 00 / 22 42 13 / 22 42 16 / 22 42 19  
 22 42 23 / 22 42 26 / 22 42 29 / 22 42 33 / 22 42 36 / 22 42 39 / 22 42 43 / 22 43 00  
 22 43 13 / 22 43 16 / 22 43 19 / 22 43 23 / 22 43 39 / 22 43 43 / 22 45 00 / 22 45 13  
 22 45 16 / 22 45 26 / 22 45 29 / 22 45 33 / 22 45 36 / 22 46 00 / 22 46 13 / 22 46 16  
 22 46 39 / 22 46 43 / 22 46 53 / 22 47 00 / 22 47 13 / 22 47 23

<p>100</p>	<p>See <a href="#">D20</a></p>	
------------	--------------------------------	--

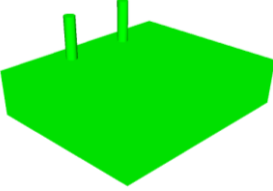
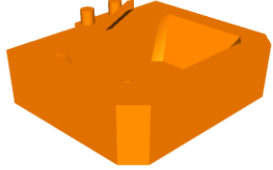
## Unifomat Omniclass

200	Schematic layout with approximate size, shape, and location of fixtures; carrier and wall width requirements modeled;	 <i>129 D2010.60-LOD-200 Plumbing Fixtures</i>
300	Modeled as design-specified size, shape, spacing, and location of fixtures; Approximate allowances for spacing and clearances required for all specified supports that are to be utilized in the layout of all fixtures; access/code clearance requirements modeled.	 <i>130 D2010.60-LOD-200 Plumbing Fixtures</i>
350	Modeled as actual construction elements size, shape, spacing, and location/connections of fixtures/carriers; Actual size, shape, spacing, and clearances required for all supports that are utilized in the layout of all fixtures. Actual access/code clearance requirements modeled.	 <i>131 D2010.60-LOD-350 Plumbing Fixtures</i>
400	See <a href="#">D2010.10</a>	 <i>132 D2010.60-LOD-400 Plumbing Fixtures</i>

### D2010.90 21-04 20 10 90 Domestic Water Distribution Supplementary Components

*Includes: Common work results for plumbing, plumbing insulation, and instrumentation. Includes: expansion fittings, meters, gages, valves, hangers, supports, heat tracing, vibration and seismic controls.*

**These components are typically modeled as part of other assemblies listed in the tables above. Do not assign this Unifomat classification unless a supplementary component is modeled independently of another assembly.**

Associated Masterformat Sections: 05 45 13 / 22 05 00 / 22 05 16 / 22 05 19 / 22 05 23  
22 05 29 / 22 05 33 / 22 05 48 / 22 05 53 / 22 07 00 / 22 09 00

[Back to TOC](#)



Copyright © 2017 by BIMForum. All rights reserved

This document is copyrighted under a [Creative Commons Attribution-NonCommercial-NoDerivatives 4.0 International License](#).

## Unifomat Omniclass

### D2020 21-04 20 20 Sanitary Drainage

*Includes: Facility sanitary sewerage system located within, under, or closely associated with a structure. Include Sanitary Drainage Supplementary Components as appropriate.*



Associated Masterformat Sections: 01 86 16 / 22 13 00

100	See <a href="#">D20</a>	
200	See <a href="#">D2010</a>	

### D2020.10 21-04 20 20 10 Sanitary Sewerage Equipment

*Includes: Interceptor, separator, pumps, and septic tanks that are part of facility sanitary sewerage system.*

Associated Masterformat Sections: 22 13 23 / 22 13 26 / 22 13 29 / 22 13 33 / 22 13 36  
22 13 43 / 22 13 53

100	See <a href="#">D20</a>	
200	Schematic layout with approximate size, shape, and location of equipment;	 <p>133 D2020.10-LOD-200 Sanitary Sewerage Equipment</p>
300	Modeled as design specified size, shape, spacing, and location of equipment;  Approximate allowances for spacing and clearances required for all specified anchors, supports, vibration and seismic control that are utilized in the layout of equipment are modeled.  access/code clearance requirements modeled.	 <p>134 D2020.10-LOD-300 Sanitary Sewerage Equipment</p>
350	Actual size, shape, spacing, and clearances required for all specified anchors, supports, vibration and seismic control that are utilized in the layout of equipment;  actual access/code clearance requirements modeled.	 <p>135 D2020.10-LOD-350 Sanitary Sewerage Equipment</p>

## Uniformat Omniclass

400	Supplementary components added to the model required for fabrication and field installation	 <p>136 D2020.10-LOD-400 Sanitary Sewerage Equipment</p>
-----	---	---

### D2020.30 21-04 20 20 30 Sanitary Sewerage Piping

*Includes: Sanitary waste and vent piping system within and under structures. May Include: Sanitary piping from the structure to the utility sanitary sewer.*

Associated Masterformat Sections: 22 13 13 / 22 13 16 / 22 13 19 / 22 05 73 / 22 05 76

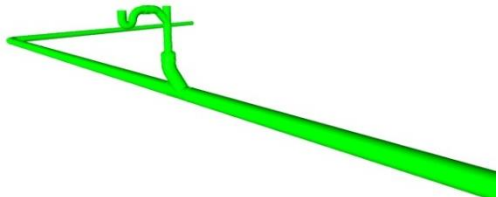
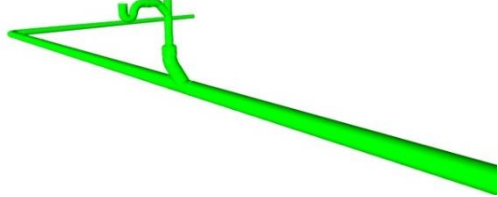
100	See <a href="#">D20</a>	
200	Schematic layout with approximate size, shape, and location of mains and risers; shaft requirements modeled;	 <p>137 D2020.30-LOD-200 Sanitary Sewerage Piping</p>
300	<p>Modeled as design-specified size, shape, spacing, location, and slope of pipe, valves, fittings, and insulation for risers, mains, and branches;</p> <p>Approximate allowances for spacing and clearances required for all specified hangers, supports, vibration and seismic control that are to be utilized in the layout of all risers, mains, and branches;</p> <p>access/code clearance requirements modeled</p>	 <p>138 D2020.30-LOD-300 Sanitary Sewerage Piping</p>

## Uniformat Omniclass

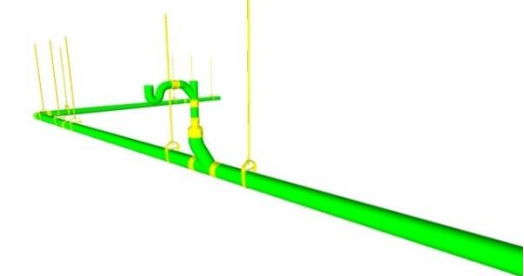
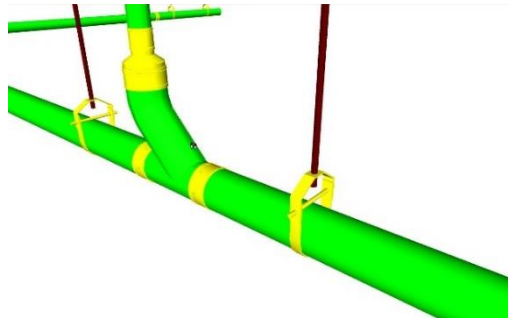
<p>350</p>	<p>Modeled as actual construction elements;</p> <p>Actual size, shape, spacing, location, connections, and slope of pipe, valves, fittings, and insulation for risers, mains, and branches;</p> <p>Actual size, shape, spacing, and clearances required for all hangers, supports, vibration and seismic control that are utilized in the layout of all risers, mains, and branches;</p> <p>Actual floor and wall penetration elements modeled.</p> <p>Actual access/code clearance requirements modeled</p>	 <p>139 D2020.30-LOD-350 Sanitary Sewerage Piping</p>
<p>400</p>	<p>See <a href="#">D2020.10</a></p>	 <p>140 D2020.30-LOD-400 Sanitary Sewerage Piping</p>

### D2020.90 21-04 20 20 90 Sanitary Drainage Supplementary Components

*Includes: Common work results for plumbing, plumbing insulation, and instrumentation and control for plumbing to be included with sanitary drainage elements above as appropriate. Includes expansion fittings, meters, gages, valves, hangers, supports, heat tracing, vibration and seismic controls.*

**These components are typically modeled as part of other assemblies listed in the tables above. Do not assign this Uniformat classification unless a supplementary component is modeled independently of another assembly.**

Associated Masterformat Sections: 05 45 13 / 22 05 00 / 22 05 16 / 22 05 19 / 22 05 23  
22 05 29 / 22 05 33 / 22 05 48 / 22 05 53 / 22 07 00 / 22 09 00

### D2030 21-04 20 30 Building Support Plumbing Systems

*Includes: Facility storm water drainage and gray water systems. Include Building Support Plumbing System Supplementary Components as appropriate.*

Associated Masterformat Sections: 01 86 16 / 22 14 00

<p>100</p>	<p>See <a href="#">D20</a></p>	
<p>200</p>	<p>See <a href="#">D2010</a></p>	

### D2030.10 21-04 20 30 10 Stormwater Drainage Equipment





*Includes: Drainage pumps, and sump pumps that are part of stormwater drainage system.*

Associated Masterformat Sections: 22 14 29 / 22 14 33 / 22 14 36 / 22 14 53

[Back to TOC](#)



## Unifomat Omniclass

100	Diagrammatic or schematic model elements; conceptual and/or schematic layout;	
200	Schematic layout with approximate size, shape, and location of equipment; approximate access/code clearance requirements modeled;	 <p><i>141 D2030.10-LOD-200 Stormwater Drainage Equipment</i></p>
300	Modeled as design-specified size, shape, spacing, and location of equipment; approximate allowances for spacing and clearances required for all specified anchors, supports, vibration and seismic control that are utilized in the layout of equipment; access/code clearance requirements modeled.	 <p><i>142 D2030.10-LOD-300 Stormwater Drainage Equipment</i></p>
350	Modeled as actual construction elements size, shape, spacing, and location/connections of equipment, actual size, shape, spacing, and clearances required for all specified anchors, supports, vibration and seismic control that are utilized in the layout of equipment; actual access/code clearance requirements modeled.	 <p><i>143 D2030.10-LOD-350 Stormwater Drainage Equipment</i></p>
400	Supplementary components added to the model required for fabrication and field installation.	 <p><i>144 D2030.10-LOD-400 Stormwater Drainage Equipment</i></p>

### D2030.20 21-04 20 30 20 Stormwater Drainage Piping

*Includes: Storm drainage piping system within, under, or closely associated with a structure. Includes storm drains for areas closely associated with a structure such as courtyards, plazas, and loading dock areas. May Include: Storm drainage piping from the structure to the utility storm drain.*



# Unifomat Omniclass

Associated Masterformat Sections: 22 05 73 / 22 05 76 / 22 14 13 / 22 14 16 / 22 14 23

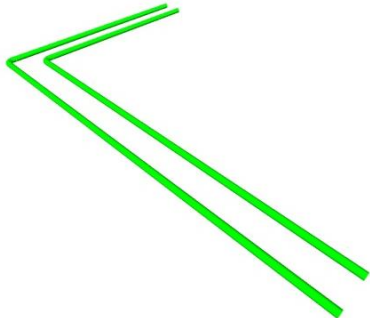
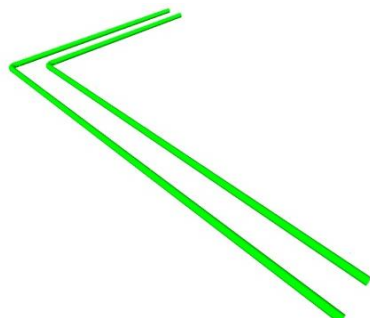
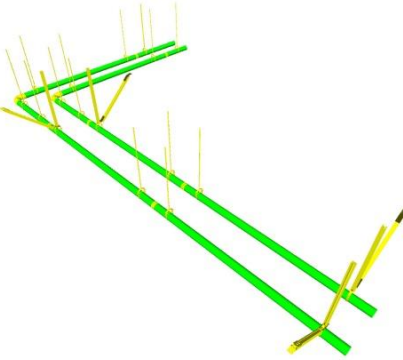
100	See <a href="#">D20</a>	
200	<p>Schematic layout with approximate size, shape, and location of mains and risers;</p> <p>shaft requirements modeled;</p>	 <p><i>145 D2030.20-LOD-200 Stormwater Drainage Piping</i></p>
300	<p>Modeled as design-specified size, shape, spacing, location, and slope of pipe, valves, fittings, and insulation for risers, mains, and branches;</p> <p>approximate allowances for spacing and clearances required for all specified hangers, supports, vibration and seismic control that are to be utilized in the layout of all risers, mains, and branches;</p> <p>access/code clearance requirements modeled.</p>	 <p><i>146 D2030.20-LOD-300 Stormwater Drainage Piping</i></p>
350	<p>Modeled as actual size, shape, spacing, location, connections, and slope of pipe, valves, fittings, and insulation for risers, mains, and branches;</p> <p>actual size and shape, spacing, and clearances required for all hangers, supports, vibration and seismic control that are utilized in the layout of all risers, mains, and branches;</p> <p>Actual access/code clearance requirements modeled.</p> <p>actual floor and wall penetration elements modeled.</p>	 <p><i>147 D2030.20-LOD-350 Stormwater Drainage Piping</i></p>

# Unifomat Omniclass

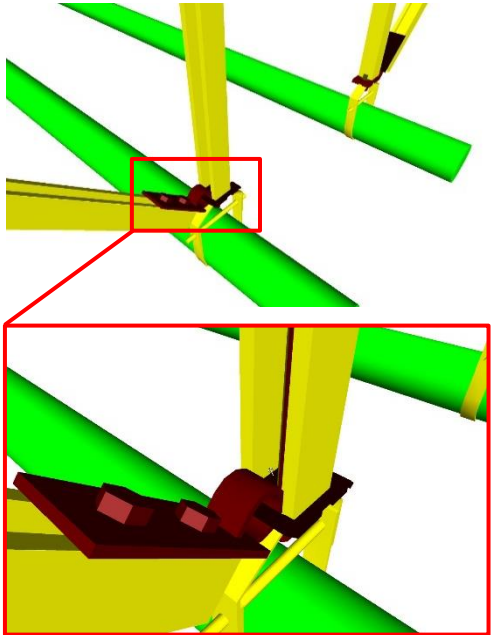
<p>400</p> <p>See <a href="#">D2030.10</a></p>		 <p>148 D2030.20-LOD-400 Stormwater Drainage Piping</p>
--	--	---

## D2030.30 21-04 20 30 30 Facility Stormwater Drains

*Includes: Various types of drains to collect storm water.*

Associated Masterformat Sections: 22 14 26

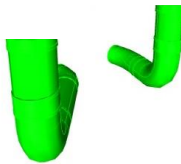
<p>100</p> <p>See <a href="#">D20</a></p>		
<p>200</p> <p>Schematic layout with approximate size, shape, and location of components;</p>		 <p>149 D2030.30-LOD-200 Facility Stormwater Drains</p>

## Uniformat Omniclass

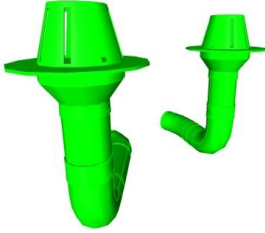
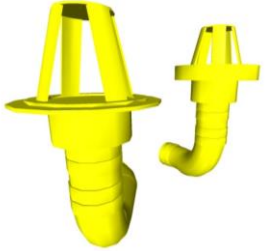
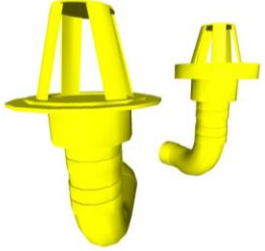
300	<p>Modeled as design-specified size, shape, spacing, and location of components;</p> <p>approximate allowances for spacing and clearances required for all specified hangers, supports, vibration and seismic control that are to be utilized in the layout of all components;</p> <p>access/code clearance requirements modeled.</p>	 <p>150 D2030.30-LOD-300 Facility Stormwater Drains</p>
350	<p>Modeled as actual construction elements size, shape, spacing, and location/connections of components;</p> <p>actual size, shape, spacing, and clearances required for all hangers, supports, vibration and seismic control that are utilized in the layout of all components.</p> <p>Actual access/code clearance requirements modeled.</p>	 <p>151 D2030.30-LOD-350 Facility Stormwater Drains</p>
400	<p>See <a href="#">D2030.10</a></p>	 <p>152 D2030.30-LOD-400 Facility Stormwater Drains</p>

**D2030.60**      21-04 20 30 60      **Gray Water Systems**  
*Includes: Systems to collect, treat, and distribute gray water for other uses such as irrigation.*

Associated Masterformat Sections: 22 13 63

[See [D2030.20](#)]

**D2030.90**      21-04 20 30 90      **Building Support Plumbing System Supplementary Components**

*Includes: Common work results for plumbing, plumbing insulation, and instrumentation and control for plumbing to be included with building support plumbing system elements above as appropriate. Includes expansion fittings, meters, gages, valves, hangers, supports, heat tracing, vibration and seismic controls.*

**These components are typically modeled as part of other assemblies listed in the tables above. Do not assign this Uniformat classification unless a supplementary component is modeled independently of another assembly.**

## Unifomat Omniclass

Associated Masterformat Sections: 05 45 13 / 22 05 00 / 22 05 16 / 22 05 19 / 22 05 23  
22 05 29 / 22 05 33 / 22 05 48 / 22 05 53 / 22 07 00 / 22 09 00

### D2050 21-04 20 50 General Service Compressed-Air

*Includes: Compressed air system serving general service requirements*

Associated Masterformat Sections: 01 86 16 / 22 15 00 / 22 15 13 / 22 15 16 / 22 15 19

[See [D2060.10](#) – Compressed-Air Systems]

### D2060 21-04 20 60 Process Support Plumbing Systems

*Includes: Process Support Plumbing System Supplementary Components as appropriate.*

Associated Masterformat Sections:

100	See <a href="#">D20</a>	
200	Schematic layout with approximate size, shape, and location of mains and risers; shaft requirements modeled;	

### D2060.10 21-04 20 60 10 Compressed-Air Systems

Associated Masterformat Sections: 01 86 16 / 22 61 00 / 22 61 13 / 22 61 19

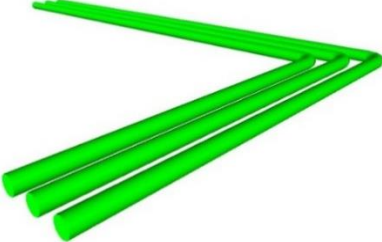
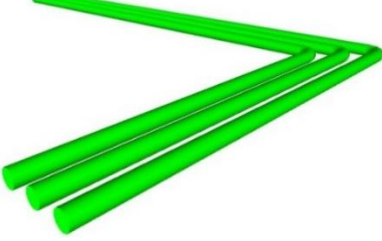
100	See <a href="#">D20</a>	
200	See <a href="#">D2060</a>	 <p><i>153D2060.10-LOD-200 Compressed-Air Systems</i></p>
300	Modeled as design-specified size, shape, spacing, location, and slope of equipment/pipe, valves, fittings, and insulation for risers, mains, and branches;  approximate allowances for spacing and clearances required for all specified hangers, supports, vibration and seismic control that are to be utilized in the layout of all risers, mains, and branches;  access/code clearance requirements modeled.	 <p><i>154D2060.10-LOD-300 Compressed-Air Systems</i></p>

## Unifomat Omniclass

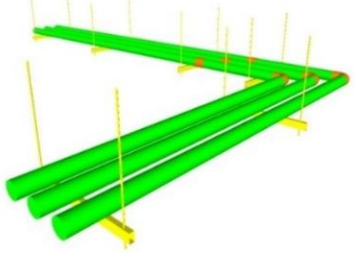
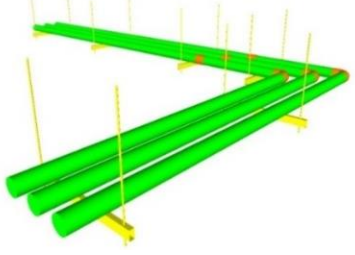
<p>350</p>	<p>Modeled as actual size, shape, spacing, location, connections, and slope of equipment/pipe, valves, fittings, and insulation for risers, mains, and branches;</p> <p>actual size, shape, spacing, and clearances required for all hangers, supports, vibration and seismic control that are utilized in the layout of all risers, mains, and branches;</p> <p>actual access/code clearance requirements modeled.</p> <p>actual floor and wall penetration elements modeled.</p>	 <p>155D2060.10-LOD-350 Compressed-Air Systems</p>
<p>400</p>	<p>Supplementary components added to the model required for fabrication and field installation.</p>	 <p>156D2060.10-LOD-400 Compressed-Air Systems</p>

### D2060.20 21-04 20 60 20 Vacuum Systems

*Includes: Vacuum systems for laboratory and healthcare purposes.*

Associated Masterformat Sections: 01 86 16 / 22 62 00 / 22 62 13 / 22 62 19 / 22 62 23

[See [D2060.10](#)]

### D2060.30 21-04 20 60 30 Gas Systems

*Includes: Gas systems for laboratory and healthcare purposes.*

Associated Masterformat Sections: 01 86 16 / 22 63 00 / 22 63 13 / 22 63 19

[See [D2060.10](#)]

### D2060.40 21-04 20 60 40 Chemical-Waste Systems

*Includes: Chemical-waste systems for laboratory and healthcare purposes.*

Associated Masterformat Sections: 01 86 16 / 22 66 00 / 22 66 53 / 22 66 70 / 22 66 83

[See [D2060.10](#)]

### D2060.50 21-04 20 60 50 Processed Water Systems

*Includes: Processed water systems for laboratory and healthcare purposes.*

Associated Masterformat Sections: 01 86 16 / 22 67 00 / 22 67 13 / 22 67 19

[See [D2060.10](#)]

## Uniformat Omniclass

### D2060.90 21-04 20 60 90 Process Support Plumbing System Supplementary Components

*Includes expansion fittings, meters, gages, valves, hangers, supports, heat tracing, vibration and seismic controls. Includes: Common work results for plumbing, plumbing insulation, and instrumentation and controls to be included with process support plumbing systems elements above as appropriate.*

**These components are typically modeled as part of other assemblies listed in the tables above. Do not assign this Uniformat classification unless a supplementary component is modeled independently of another assembly.**

Associated Masterformat Sections: 05 45 13 / 05 45 23 / 22 05 00 / 22 05 23 / 22 05 29 / 22 05 33 / 22 05 48 / 22 05 53 / 22 07 00 / 22 09 00

### D30 21-04 30 Heating, Ventilation, and Air Conditioning (HVAC)

Associated Masterformat Sections: 01 86 19 / 23 00 00

100	Diagrammatic or schematic model elements; conceptual and/or schematic layout/flow diagram;	
-----	---	--

### D3010 21-04 30 10 Facility Fuel Systems

*Includes: Fuel-oil, gasoline, natural-gas, and liquefied-petroleum fuel systems associated with a structure.*

Associated Masterformat Sections: 01 86 19 / 23 10 00

100	See <a href="#">D30</a>	
200	Schematic layout with approximate size, shape, and location of element(s); approximate access/code clearance requirements modeled; shaft requirements modeled;	

### D3010.10 21-04 30 10 10 Fuel Piping

*Includes: Fuel piping, valves, piping specialties, and other components within, under, or closely associated with a structure.*

Associated Masterformat Sections: 23 11 00

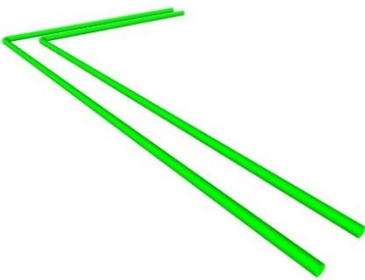
100	See <a href="#">D30</a>	
200	See <a href="#">D3010</a>	 <p style="text-align: center;">157 D3010.10-200 Fuel Piping</p>

# Unifomat Omniclass

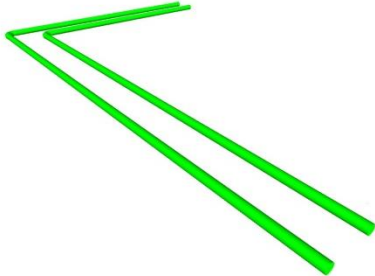
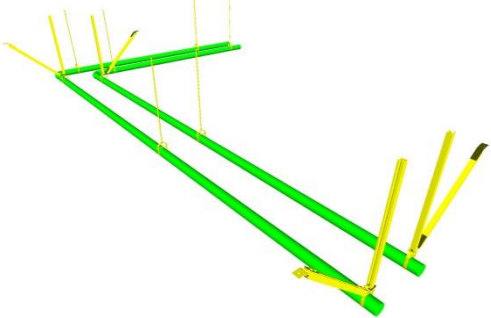
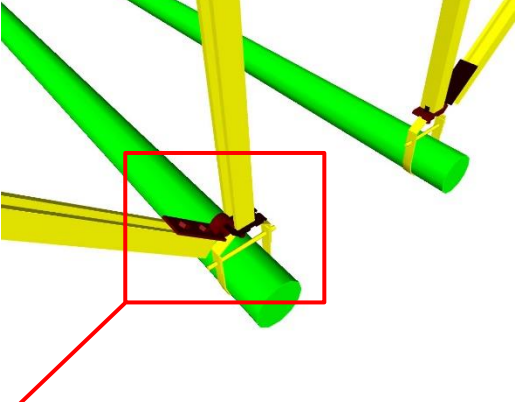
<p>300</p>	<p>Modeled as design-specified size, shape, spacing, and location of pipe, valves, fittings, and insulation for risers, mains, and branches;</p> <p>approximate allowances for spacing and clearances required for all specified hangers, supports, vibration and seismic control that are to be utilized in the layout of all risers, mains, and branches;</p> <p>access/code clearance requirements modeled.</p>	 <p>158 D3010.10-300 Fuel Piping</p>
<p>350</p>	<p>Modeled as actual size, shape, spacing, and location/connections of pipe, valves, fittings, and insulation for risers, mains, and branches;</p> <p>actual size, shape, spacing, and clearances required for all hangers, supports, vibration and seismic control that are utilized in the layout of all risers, mains, and branches;</p> <p>actual access/code clearance requirements modeled.</p> <p>actual floor and wall penetration elements modeled.</p>	 <p>159 D3010.10-350 Fuel Piping</p>
<p>400</p>	<p>Supplementary components added to the model required for fabrication and field installation</p>	

## Uniformat Omniclass

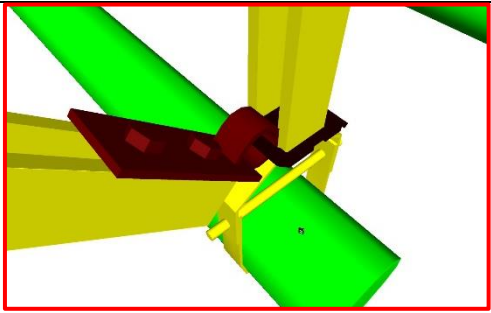
		 <p>160 D3010.10-400 Fuel Piping</p>
--	--	--

### D3010.30 21-04 30 10 30 Fuel Pumps

*Includes: Fuel pumps within or closely associated with a structure.*

Associated Masterformat Sections: 23 12 00 / 23 12 13 / 23 12 16

100	See <a href="#">D30</a>	
200	See <a href="#">D3010</a>	
300	<p>Modeled as design-specified size, shape, spacing, and location of equipment;</p> <p>approximate allowances for spacing and clearances required for all specified anchors, supports, vibration and seismic control that are utilized in the layout of equipment;</p> <p>access/code clearance requirements modeled.</p>	
350	<p>Modeled as actual size, shape, spacing, and location/connections of equipment;</p> <p>actual size, shape, spacing, and clearances required for all specified anchors, supports, vibration and seismic control that are utilized in the layout of equipment.</p> <p>actual access/code clearance requirements modeled.</p>	
400	See <a href="#">D3010.10</a>	

### D3010.50 21-04 30 10 50 Fuel Storage Tanks

*Includes: Fuel tanks under or closely associated with a structure.*

Associated Masterformat Sections: 23 13 00

100	See <a href="#">D30</a>	
-----	-------------------------	--



## Unifomat Omniclass

200	See <a href="#">D3010</a>	 <p><i>161 D3010.50-LOD-200 Fuel Storage Tanks</i></p>
300	<p>Modeled as design-specified size, shape, spacing, and location of tank(s);</p> <p>approximate allowances for spacing and clearances required for all specified anchors, supports, vibration and seismic control that are utilized in the layout of tanks(s);</p> <p>access/code clearance requirements modeled.</p>	 <p><i>162 D3010.50-LOD-300 Fuel Storage Tanks</i></p>
350	<p>Modeled as actual size, shape, spacing, and location/connections of tank(s);</p> <p>actual size, shape, spacing, and clearances required for all specified anchors, supports, vibration and seismic control that are utilized in the layout of tanks(s).</p> <p>actual access/code clearance requirements modeled.</p>	 <p><i>163 D3010.50-LOD-350 Fuel Storage Tanks</i></p>
400	See <a href="#">D3010.10</a>	 <p><i>164 D3010.50-LOD-400 Fuel Storage Tanks</i></p>

### D3020

21-04 30 20

### Heating Systems

*Includes: Associated ductwork, piping, valves, and specialties. Includes: Heating System Supplementary Components as appropriate.*

[Back to TOC](#)



Copyright © 2017 by BIMForum. All rights reserved

This document is copyrighted under a [Creative Commons Attribution-NonCommercial-NoDerivatives 4.0 International License](#).

## Unifomat Omniclass

Associated Masterformat Sections: 01 86 19

100	See <a href="#">D30</a>	
200	Schematic layout with approximate size, shape, and location of element(s);  shaft requirements modeled;	

### D3020.10 21-04 30 20 10 Heat Generation

*Includes: Boilers, furnaces, solar, geothermal, and biomass heat generation, fuel fired heaters, and heat exchangers. Includes: Fuel-fired boilers and generators for hot water and steam systems. Includes breechings, chimneys, and stacks. Includes: Electric boilers and generators for hot water and steam systems. Includes: Equipment to remove oxygen and other dissolved gases in boiler feed. Includes: Fuel-fired and electric furnaces. Includes: Equipment powered by solar energy. Includes: Fuel-fired radiant and unit heaters. Includes: Equipment used to transfer heat from one medium to another.*

Associated Masterformat Sections: 23 51 00 / 23 52 00 / 23 52 13 / 23 53 00 / 23 53 13 / 23 53 16 / 23 54 00 / 23 56 00 / 23 56 13 / 23 56 16 / 23 55 00 / 23 57 00

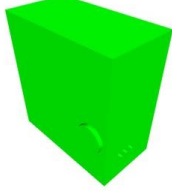
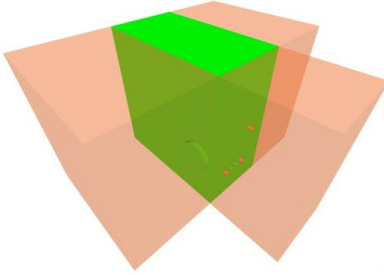
100	See <a href="#">D30</a>	
200	See <a href="#">D3020</a>	 <p>165 D3020.10-LOD-200 Heat Generation</p>
300	Modeled as design-specified size, shape, spacing, and location of equipment;  approximate allowances for spacing and clearances required for all specified anchors, supports, vibration and seismic control that are utilized in the layout of equipment;  access/code clearance requirements modeled.	 <p>166 D3020.10-LOD-300 Heat Generation</p>

## Unifomat Omniclass

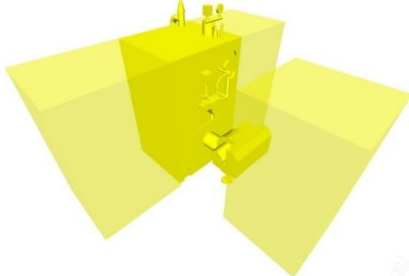
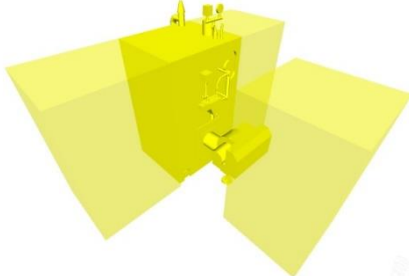
350	<p>Modeled as actual size, shape, spacing, and location/connections of equipment,</p> <p>actual size, shape, spacing, and clearances required for all specified anchors, supports, vibration and seismic control that are utilized in the layout of equipment.</p> <p>actual access/code clearance requirements modeled.</p>	 <p>167D3020.10-LOD-350 Heat Generation</p>
400	<p>Supplementary components added to the model required for fabrication and field installation.</p>	 <p>168D3020.10-LOD-400 Heat Generation</p>

### D3020.30 21-04 30 20 30 Thermal Heat Storage

*Includes: Equipment to store thermal energy for use in heating and with charging or discharging this energy at a controllable rate.*

Associated Masterformat Sections: 23 71 13

[See [D3020.10](#)]

### D3020.70 21-04 30 20 70 Decentralized Heating Equipment

*Includes: Heating equipment that serves a portion of a HVAC system. Includes: Convection units may provide heating and cooling. Includes: Electric cables or panels and hydronic piping used for radiant heating for space heating.*

Associated Masterformat Sections: 23 80 00 / 23 82 00 / 23 82 13 / 23 82 14 / 23 82 16 / 23 82 19 / 23 82 23 / 23 82 26 / 23 82 29 / 23 82 33 / 23 82 36 / 23 82 39 / 23 83 00

[See [D3020.10](#)]

### D3020.90 21-04 30 20 90 Heating System Supplementary Components

*Includes: Common work results for HVAC, insulation, and instrumentation and control to be included in heating system elements above as appropriate.*

**These components are typically modeled as part of other assemblies listed in the tables above. Do not assign this Unifomat classification unless a supplementary component is modeled independently of another assembly.**

Associated Masterformat Sections: 05 45 13 / 23 05 00 / 23 05 19 / 23 05 23 / 23 05 29 / 23 05 48 / 23 05 53 / 23 05 63 / 23 05 66 / 23 05 93 / 23 07 00 / 23 09 00

### D3030 21-04 30 30 Cooling Systems

*Includes: Associated ductwork, piping, valves, and specialties. Includes: Cooling System Supplementary Components as appropriate.*

[Back to TOC](#)



Copyright © 2017 by BIMForum. All rights reserved

This document is copyrighted under a [Creative Commons Attribution-NonCommercial-NoDerivatives 4.0 International License](#).

## Unifomat Omniclass

Associated Masterformat Sections: 01 86 19

100	See <a href="#">D30</a>	
200	Schematic layout with approximate size, shape, and location of element(s);  shaft requirements modeled;	

### D3030.10

### 21-04 30 30 10 Central Cooling

*Includes: Refrigerant compressors, condensers, packaged compressor and condenser units, water chillers, and cooling towers. Includes: Various type of compressors used in refrigeration process. Includes: Condensing units used to reject heat from the refrigeration process. Includes: Compressor in combination with condensing units used to reject heat from the refrigeration process. Includes: Various types of chillers used for building space cooling. Includes: Factory- and field-fabricated cooling towers and liquid coolers. Includes piping and specialties; chemical water treatment; vibration and seismic controls; and integral controls not a part of the condenser water distribution systems.*

Associated Masterformat Sections: 23 60 00 / 23 61 00 / 23 62 00 / 23 63 00 / 23 64 00 / 23 65 00

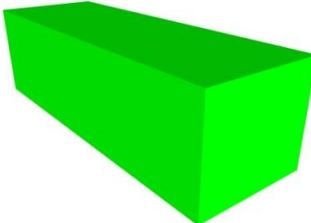
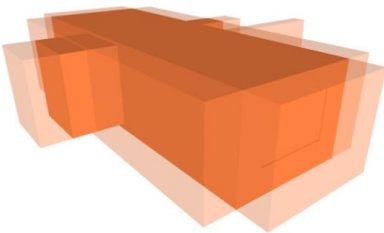
100	See <a href="#">D30</a>	
200	See <a href="#">D3030</a>	 <p>169 D3030.10-LOD-200 Central Cooling</p>
300	Modeled as design-specified size, shape, spacing, and location of equipment;  approximate allowances for spacing and clearances required for all specified anchors, supports, vibration and seismic control that are utilized in the layout of equipment;  access/code clearance requirements modeled.	 <p>170 D3030.10-LOD-300 Central Cooling</p>

## Unifomat Omniclass

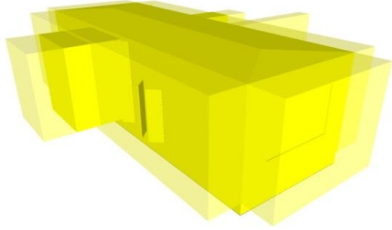
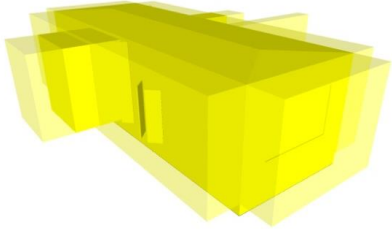
350	<p>Modeled as actual size, shape, spacing, and location/connections of equipment;</p> <p>actual size, shape, spacing, and clearances required for all specified anchors, supports, vibration and seismic control that are utilized in the layout of equipment.</p> <p>actual access/code clearance requirements modeled.</p>	 <p><i>171 D3030.10-LOD-350 Central Cooling</i></p>
400	<p>Supplementary components added to the model required for fabrication and field installation.</p>	 <p><i>172 D3030.10-LOD-400 Central Cooling</i></p>

### D3030.30 21-04 30 30 30 Evaporative Air-Cooling

*Includes: Equipment used to reject heat from the refrigeration process by evaporation.*

Associated Masterformat Sections: 23 76 00

100	See <a href="#">D3030.10</a>	
200	See <a href="#">D3030.10</a>	 <p><i>173 D3030.30-LOD-200 Evaporative Air-Cooling</i></p>

# Unifomat Omniclass

300	See <a href="#">D3030.10</a>	 <p>174D3030.30-LOD-300 Evaporative Air-Cooling</p>
350	See <a href="#">D3030.10</a>	 <p>175D3030.30-LOD-350 Evaporative Air-Cooling</p>
400	See <a href="#">D3030.10</a>	 <p>176D3030.30-LOD-400 Evaporative Air-Cooling</p>

## **D3030.50**      21-04 30 30 50      **Thermal Cooling Storage**

*Includes: Equipment to store thermal energy for use in cooling and with charging or discharging this energy at a controllable rate.*

Associated Masterformat Sections: 23 71 00 / 23 71 16 / 23 71 19

[See [D3030.10](#)]

## **D3030.70**      21-04 30 30 70      **Decentralized Cooling**

*Includes: Cooling equipment that serves a portion of a HVAC system. Note: Convection units may provide heating and cooling.*

Associated Masterformat Sections: 23 80 00 / 23 81 13 / 23 81 16 / 23 81 19 / 23 81 23 /  
23 81 26 / 23 81 43 / 23 81 46 / 23 82 00 / 23 82 13 / 23 82 14 / 23 82 16 / 23 82 19 /  
23 82 23 / 23 82 26

[Back to TOC](#)



Copyright © 2017 by BIMForum. All rights reserved

This document is copyrighted under a [Creative Commons Attribution-NonCommercial-NoDerivatives 4.0 International License](#).

## Uniformat Omniclass

[See [D3030.10](#)]

### D3030.90 21-04 30 30 90 Cooling System Supplementary Components

*Includes expansion fittings, meters, gages, valves, hangers, supports, heat tracing, vibration and seismic controls. Includes: Common work results for HVAC, insulation, and instrumentation and control to be included in cooling system elements above as appropriate.*

**These components are typically modeled as part of other assemblies listed in the tables above. Do not assign this Uniformat classification unless a supplementary component is modeled independently of another assembly.**

Associated Masterformat Sections: 05 45 13 / 23 05 00 / 23 05 19 / 23 05 23 / 23 05 29 / 23 05 48 / 23 05 53 / 23 05 63 / 23 05 66 / 23 05 93 / 23 07 00 / 23 09 00

### D3050 21-04 30 50 Facility HVAC Distribution Systems

*Includes: Facility Distribution Systems Supplementary Components as appropriate.*

Associated Masterformat Sections:

100	See <a href="#">D30</a>	
200	Schematic layout with approximate size, shape, and location of element(s);	

### D3050.10 21-04 30 50 10 Facility Hydronic Distribution

*Includes: Piping systems and equipment for distribution of heating hot water and cooling chilled water. Includes piping systems, pumps, tanks, supports and anchors, vibration and seismic controls, identification, and piping and equipment insulation.*

Associated Masterformat Sections: 01 86 19 / 23 21 13 / 23 21 23 / 23 25 00

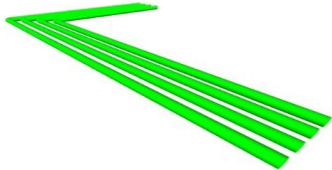
100	See <a href="#">D30</a>	
200	See <a href="#">D3050</a>	 <p>177 D3050.10-LOD-200 Facility Hydronic distribution</p>

# Unifomat Omniclass

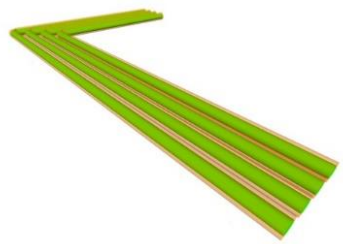
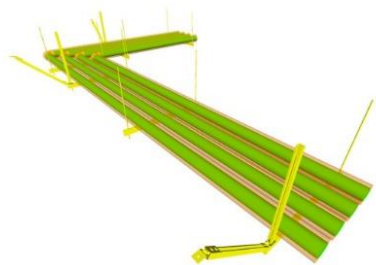
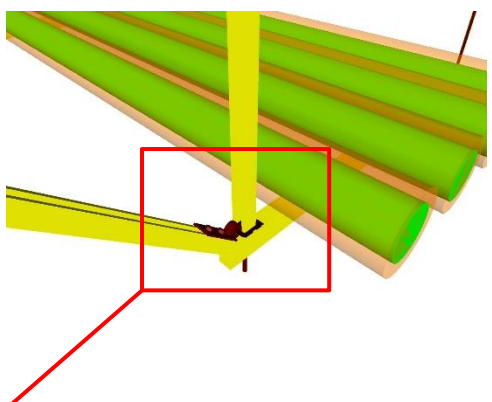
<p>300</p>	<p>Modeled as design-specified size, shape, spacing, location, and slope of pipe, valves, fittings, and insulation for risers, mains, and branches;</p> <p>approximate allowances for spacing and clearances required for all specified hangers, supports, vibration and seismic control that are to be utilized in the layout of all risers, mains, and branches;</p> <p>access/code clearance requirements modeled.</p>	 <p><i>178 D3050.10-LOD-300 Facility Hydronic Distribution</i></p>
<p>350</p>	<p>Modeled as actual size, shape, spacing, location, connections, and slope of pipe, valves, fittings, and insulation for risers, mains, and branches;</p> <p>actual size, shape, spacing, and clearances required for all hangers, supports, vibration and seismic control that are utilized in the layout of all risers, mains, and branches;</p> <p>actual floor and wall penetration elements modeled.</p> <p>actual access/code clearance requirements modeled.</p>	 <p><i>179D3050.10-LOD-350 Facility Hydronic Distribution</i></p>
<p>400</p>	<p>Supplementary components added to the model required for fabrication and field installation.</p>	

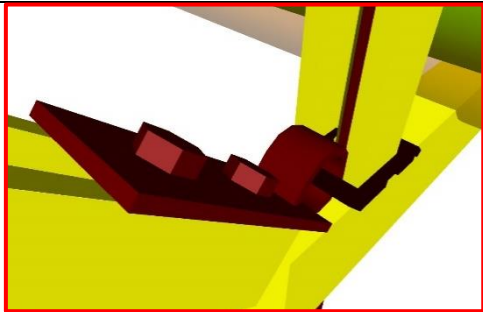

## Unifomat Omniclass

		 <p>180 D3050.10-LOD-400 Facility Hydronic Distribution</p>
--	--	--

### D3050.30 21-04 30 50 30 Facility Steam Distribution

*Includes: Piping systems and equipment for distribution of steam and condensate return. Includes piping systems, pumps, tanks, supports and anchors, vibration and seismic controls, identification, and piping and equipment insulation.*

Associated Masterformat Sections: 01 86 19 / 23 22 13 / 23 22 23 / 23 25 19

[See [D3050.10](#)]

### D3050.50 21-04 30 50 50 HVAC Air Distribution

*Includes: Systems for distribution of air including supply systems, return systems, and general exhaust systems. Does not include special exhaust systems such as kitchen hood, paint booth, and fume hood exhaust systems. Includes: Air-handling units consisting of fans, coils, dampers, control devices, and other accessories. Includes: Ducts, duct accessories, fans, terminal units, and air inlets and outlets. Includes: Devices of a variety of types to clean distribution air. Includes: Equipment that adds or removes moisture from a medium in order to control the humidity.*

Associated Masterformat Sections: 01 86 19 / 23 73 00 / 23 74 00 / 23 75 00 / 23 30 00 / 23 34 00 / 23 31 00 / 23 32 00 / 23 33 00 / 23 36 00 / 23 37 00 / 23 40 00 / 23 41 00 / 23 42 00 / 23 43 00 / 23 84 00

100	See <a href="#">D30</a>	
200	See <a href="#">D3050</a>	
300	<p>Modeled as design-specified size, shape, spacing, and location of duct, dampers, fittings, and insulation for risers, mains, and branches;</p> <p>approximate allowances for spacing and clearances required for all specified hangers, supports, vibration and seismic control that are to be utilized in the layout of all risers, mains, and branches;</p> <p>access/code clearance requirements modeled.</p>	
350	<p>Modeled as actual size, shape, spacing, and location/connections of duct, dampers, fittings, and insulation for risers, mains, and branches;</p>	

## Unifomat Omniclass

	actual size, shape, spacing, and clearances required for all hangers, supports, vibration and seismic control that are utilized in the layout of all risers, mains, and branches;  actual floor and wall penetration elements modeled.  actual access/code clearance requirements modeled.	
400	See <a href="#">D3050.10</a>	

**D3050.90**      21-04 30 50 90      **Facility Distribution Systems Supplementary Components**  
*Includes expansion fittings, meters, gages, valves, hangers, supports, heat tracing, vibration and seismic controls. Includes: Common work results for HVAC, insulation, and instrumentation and control to be included in distribution system elements above as appropriate.*

**These components are typically modeled as part of other assemblies listed in the tables above. Do not assign this Unifomat classification unless a supplementary component is modeled independently of another assembly.**

Associated Masterformat Sections: 05 45 13 / 23 05 00 / 23 05 16 / 23 05 19 / 23 05 23 / 23 05 29 / 23 05 33 / 23 05 48 / 23 05 53 / 23 05 63 / 23 05 66 / 23 05 93 / 23 07 00 / 23 09 00

## D3060      21-04 30 60      Ventilation

*Includes: Supply air, return air, exhaust air, outside air, and air cleaning systems. Includes Ventilation Supplementary Components as appropriate.*

Associated Masterformat Sections: 01 86 19

100	See <a href="#">D30</a>	
200	Schematic layout with approximate size, shape, and location of mains and risers;	

## D3060.10      21-04 30 60 10      Supply Air

Associated Masterformat Sections: 23 34 00 / 23 31 00 / 23 32 00 / 23 33 00 / 23 36 00 / 23 37 00

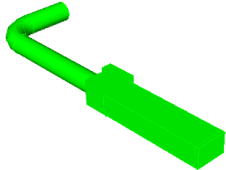
100	See <a href="#">D30</a>	
200	See <a href="#">D3060</a>	 <p>181 D3060.10-LOD-200 Supply Air</p>

## Unifomat Omniclass

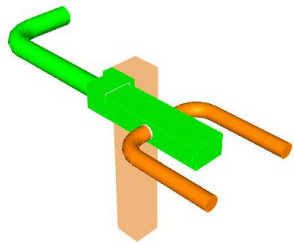
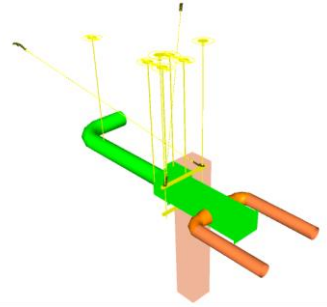
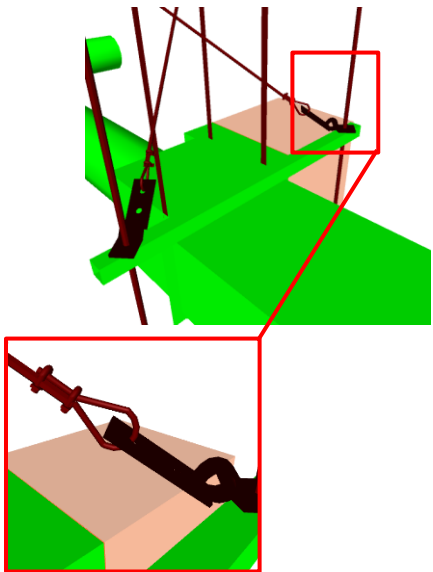
<p>300</p>	<p>Modeled as design-specified size, shape, spacing, and location of duct, dampers, fittings, and insulation for risers, mains, and branches;</p> <p>approximate specified allowances for spacing and clearances required for all hangers, supports, vibration and seismic control that are to be utilized in the layout of all risers, mains, and branches;</p> <p>access/code clearance requirements modeled.</p>	 <p><i>182 D3060.10-LOD-300 Supply Air</i></p>
<p>350</p>	<p>Modeled as actual size, shape, spacing, and location/connections of duct, dampers, fittings, and insulation for risers, mains, and branches;</p> <p>actual size, shape, spacing, and clearances required for all hangers, supports, vibration and seismic control that are utilized in the layout of all risers, mains, and branches;</p> <p>actual floor and wall penetration elements modeled.</p> <p>actual access/code clearance requirements modeled.</p>	 <p><i>183 D3060.10-LOD-350 Supply Air</i></p>
<p>400</p>	<p>Supplementary components added to the model required for fabrication and field installation.</p>	 <p><i>184 D3060.10-LOD-400 Supply Air</i></p>

## Unifomat Omniclass

### D3060.20 21-04 30 60 20 Return Air

Associated Masterformat Sections: 23 34 00 / 23 31 00 / 23 32 00 / 23 33 00 / 23 37 00

[See [D3060.10](#)]

### D3060.30 21-04 30 60 30 Exhaust Air

*Includes: Special systems for exhausting air such as kitchen hood, paint booth, and fume hood exhaust systems.*

Associated Masterformat Sections: 23 35 00 / 23 35 13.13 / 23 35 16 / 23 38 00 / 23 38 13 / 23 38 16 / 23 34 00 / 23 31 00 / 23 32 00 / 23 33 00 / 23 37 00

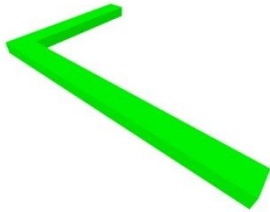
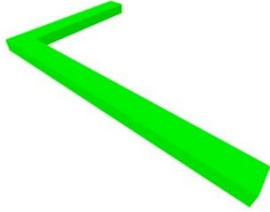
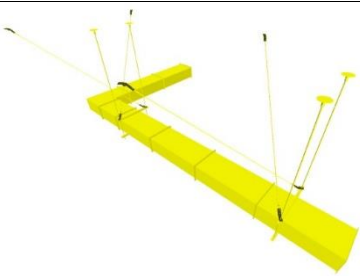
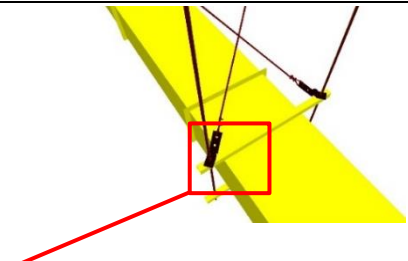
100	See <a href="#">D30</a>	
200	See <a href="#">D3060</a>	 <p>185 D3060.30-LOD-200 Exhaust Air</p>
300	Modeled as design-specified size, shape, spacing, location, duct slope (if required), dampers, fittings, insulation for risers, mains, and branches; approximate specified allowances for spacing and clearances required for all hangers, supports, vibration and seismic control that are to be utilized in the layout of all risers, mains, and branches; access/code clearance requirements modeled.	 <p>186 D3060.30-LOD-300 Exhaust Air</p>
350	Modeled as actual size, shape, spacing, location, and slope (if required)/connections of duct, dampers, fittings, and insulation for risers, mains, and branches; actual size, shape, spacing, and clearances required for all hangers, supports, vibration and seismic control that are utilized in the layout of all risers, mains, and branches; actual floor and wall penetration elements modeled. actual access/code clearance requirements modeled.	 <p>187 D3060.30-LOD-350 Exhaust Air</p>
400	See <a href="#">D3060.10</a>	

## Uniformat Omniclass

		 <i>188 D3060.30-LOD-400 Exhaust Air</i>
--	--	--

**D3060.40**      21-04 30 60 40      **Outside Air**  
 Associated Masterformat Sections: 23 34 00 / 23 31 00 / 23 32 00 / 23 33 00 / 23 36 00 / 23 37 00

[See [D3060.10](#)]

**D3060.60**      21-04 30 60 60      **Air-to-Air Energy Recovery**  
*Includes: Air-to-air energy recovery units.*

Associated Masterformat Sections: 23 72 00

[See [D3060.10](#)]

**D3060.70**      21-04 30 60 70      **HVAC Air Cleaning**  
 Associated Masterformat Sections: 23 40 00

[See [D3060.10](#)]

**D3060.90**      21-04 30 60 90      **Ventilation Supplementary Components**  
*Includes expansion fittings, meters, gages, valves, hangers, supports, heat tracing, vibration and seismic controls. Includes: Common work results for HVAC, insulation, and instrumentation and control to be included in ventilation elements above as appropriate.*

**These components are typically modeled as part of other assemblies listed in the tables above. Do not assign this Uniformat classification unless a supplementary component is modeled independently of another assembly.**

Associated Masterformat Sections: 05 45 13 / 23 05 00 / 23 05 29 / 23 05 48 / 23 05 53 / 23 05 63 / 23 05 66 / 23 05 93 / 23 07 00 / 23 09 00

**D3070**      21-04 30 70      **Special Purpose HVAC Systems**

Associated Masterformat Sections:

100	See <a href="#">D30</a>	
200	Schematic layout with approximate size, shape, and location of components;	

**D3070.10**      21-04 30 70 10      **Snow Melting**  
*Includes: Electric cables and hydronic piping used for snow and ice control.*

Associated Masterformat Sections: 23 83 13 / 23 83 16

## Unifomat Omniclass

100	See <a href="#">D30</a>	
200	See <a href="#">D3070</a>	
300	Modeled as design-specified size, shape, spacing, and location of supplementary components; approximate allowances for spacing and clearances required for all specified hangers, supports, vibration and seismic control that are to be utilized in the layout of all supplementary components; access/code clearance requirements modeled.	
350	Modeled as actual size, shape, spacing, and location/connections of supplementary components; actual size, shape, spacing, and clearances required for all hangers, supports, vibration and seismic control that are utilized in the layout of all supplementary components. actual access/code clearance requirements modeled.	
400	Supplementary components added to the model required for fabrication and field installation.	

### D40 21-04 40 Fire Protection

Associated Masterformat Sections:

100	Diagrammatic or schematic model elements; conceptual and/or schematic layout/flow diagram;	
-----	---	--

### D4010 21-04 40 10 Fire Suppression

*Includes: Fire Suppression Supplementary Components as appropriate.*

Associated Masterformat Sections: 01 86 13 / 21 00 00



100	See <a href="#">D40</a>	
200	Schematic layout with approximate size, shape, and location of mains and risers;	

### D4010.10 21-04 40 10 10 Water-Based Fire-Suppression

*Includes: Systems that use water for fire extinguishing and suppression. Includes piping, fittings, and specialties; hoses, valves, cabinets; fire pumps, accessories, and controls. Includes: Piping, fittings, valves, hangers, supports, other specialties, and sprinklers for fire protection systems. Includes limited area sprinkler systems, fire pumps, accessories, and controls.*

Associated Masterformat Sections: 01 86 13 / 21 10 00 / 21 11 00 / 21 12 00 / 21 13 00 / 21 13 13 / 21 13 16 / 21 13 19 / 21 13 23 / 21 13 26 / 21 13 29 / 21 13 36 / 21 13 39 / 21 30 00 / 21 40 00

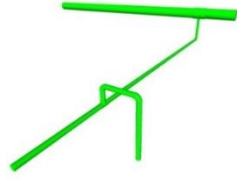
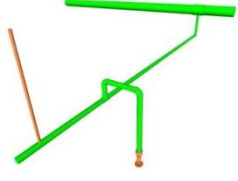
## Unifomat Omniclass

100	See <a href="#">D40</a>	
200	See <a href="#">D4010</a>	 <p><i>189 D4010.10-LOD-200 Water-Based Fire-Suppression</i></p>
300	<p>Modeled as design-specified size, shape, spacing, and location of pipe/slope (if required)/valves/fittings/insulation for risers, mains, and branches/standpipes;</p> <p>approximate allowances for spacing and clearances required for all specified hangers, supports, vibration and seismic control that are to be utilized in the layout of all risers, mains, and branches/standpipes;</p> <p>access/code clearance requirements modeled.</p>	 <p><i>190 D4010.10-LOD-300 Water-Based Fire-Suppression</i></p>
350	<p>Modeled as actual size, shape, spacing, and location/ slope (if required)/connections of pipe, valves, fittings, and insulation for risers, mains, and branches/standpipes;</p> <p>actual size, shape, spacing, and clearances required for all hangers, supports, vibration and seismic control that are utilized in the layout of all risers, mains, and branches/standpipes;</p> <p>actual floor and wall penetration elements modeled.</p> <p>actual access/code clearance requirements modeled.</p>	 <p><i>191 D4010.10-LOD-350 Water-Based Fire-Suppression</i></p>
400	Supplementary components added to the model required for fabrication and field installation.	 <p><i>192 D4010.10-LOD-400 Water-Based Fire-Suppression</i></p>

### D4010.50 21-04 40 10 50 Fire-Extinguishing

*Includes: Systems that use other than water for fire extinguishing and suppression. Includes piping, fittings, and specialties; valves, accessories, and controls.*

## Uniformat Omniclass

Associated Masterformat Sections: 21 20 00 / 21 21 00 / 21 22 00 / 21 23 00 / 21 24 00

[See [D4010.10](#)]

### D4010.90 21-04 40 10 90 Fire Suppression Supplementary Components

*Includes: Expansion fittings and loops, meters and gages, general-duty valves, hanger and supports, heat tracing, vibration and seismic controls, identification, insulation, and instrumentation and control to be included in fire protection elements above as appropriate.*

**These components are typically modeled as part of other assemblies listed in the tables above. Do not assign this Uniformat classification unless a supplementary component is modeled independently of another assembly.**

Associated Masterformat Sections: 05 45 13 / 21 05 00 / 21 05 16 / 21 05 19 / 21 05 23 / 21 05 29 / 21 05 33 / 21 05 48 / 21 05 53 / 21 07 00 / 21 09 00

### D4030 21-04 40 30 Fire Protection Specialties

*Includes: Firefighting devices and storage cabinets except devices connected to a fire suppression system.*

Associated Masterformat Sections: 10 44 00

100	See <a href="#">D40</a>	
200	Schematic layout with approximate size, shape, and location of components;	

### D4030.10 21-04 40 30 10 Fire Protection Cabinets

Associated Masterformat Sections: 10 44 13

100	See <a href="#">D40</a>	
200	See <a href="#">D4030</a>	
300	Modeled as design-specified size, shape, spacing, and location of components;  approximate allowances for spacing and clearances required for all specified hangers, supports, vibration and seismic control that are to be utilized in the layout of all components;  access/code clearance requirements modeled.	
350	Modeled as actual size, shape, spacing, and location/connections of components;  actual size, shape, spacing, and clearances required for all hangers, supports, vibration and seismic control that are utilized in the layout of all components.  actual access/code clearance requirements modeled.	
400	Supplementary components added to the model required for fabrication and field installation.	

### D4030.30 21-04 40 30 30 Fire Extinguishers

Associated Masterformat Sections: 10 44 16

[See [D4030.10](#)]

[Back to TOC](#)



Copyright © 2017 by BIMForum. All rights reserved

This document is copyrighted under a [Creative Commons Attribution-NonCommercial-NoDerivatives 4.0 International License](#).



## Uniformat Omniclass

### D4030.50 21-04 40 30 50 Breathing Air Replenishment Systems

Associated Masterformat Sections: 10 44 33

[See [D4030.10](#)]

### D4030.70 21-04 40 30 70 Fire Extinguisher Accessories

Associated Masterformat Sections: 10 44 43

[See [D4030.10](#)]

## D50 21-04 50 Electrical

Associated Masterformat Sections: 26 00 00 / 01 86 26

100	Diagrammatic or schematic model elements: conceptual and/or schematic layout;	
-----	--	--

### D5010 21-04 50 10 Facility Power Generation

*Includes: Power Generation Supplementary Components as appropriate.*

Associated Masterformat Sections: 01 86 26

100	See <a href="#">D50</a>	
200	Schematic layout with approximate size, shape, and location of equipment;	

### D5010.10 21-04 50 10 10 Packaged Generator Assemblies

*Includes: Generator, frequency changers, and rotary converters and uninterruptible power units.*

Associated Masterformat Sections: 26 32 00 / 26 32 13 / 26 32 16 / 26 32 19 / 26 32 23 / 26 32 26 / 26 32 29 / 26 32 33

100	See <a href="#">D50</a>	
200	See <a href="#">D5010</a>	 <p>193 D5010.10-LOD-200 Packaged Generator Assemblies</p>

## Unifomat Omniclass

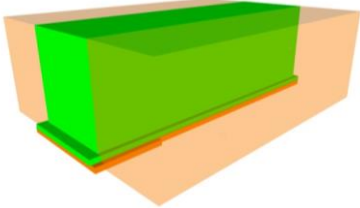
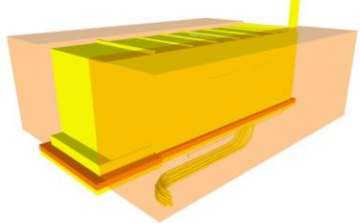
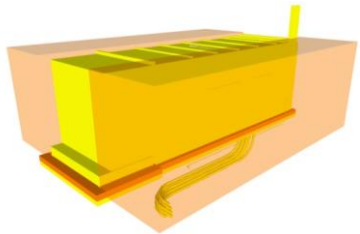
<p>300</p>	<p>Modeled as design-specified size, shape, spacing, and location of equipment and associated components; approximate allowances for spacing and clearances required for all specified supports and seismic control; access/code clearance requirements modeled.</p>	 <p>194 D5010.10-LOD-300 Packaged Generator Assemblies</p>
<p>350</p>	<p>Modeled as actual size, shape, spacing, and location of equipment and associated components; actual size, shape, spacing, and location for supports and seismic control; actual size, shape, and location/connections of equipment and support structure/pads. actual access/code clearance requirements modeled.</p>	 <p>195 D5010.10-LOD-350 Packaged Generator Assemblies</p>
<p>400</p>	<p>Supplementary components added to the model required for fabrication and field installation.</p>	 <p>196 D5010.10-LOD-400 Packaged Generator Assemblies</p>

### D5010.20 21-04 50 10 20 Battery Equipment

*Includes: Batteries, battery racks, battery chargers, static power converters, uninterruptible power supplies, and accessories.*

Associated Masterformat Sections: 26 33 00 / 26 33 13 / 26 33 16 / 26 33 19 / 26 33 23 / 26 33 33 / 26 33 43 / 26 33 46 / 26 33 53

[See [D5010.10](#)]

### D5010.30 21-04 50 10 30 Photovoltaic Collectors

*Includes: Solar cells to convert sunlight to electricity.*

Associated Masterformat Sections: 26 31 00

[See [D5010.10](#)]

## Unifomat Omniclass

### D5010.40 21-04 50 10 40 Fuel Cells

*Includes: Fuel cell electricity generating equipment.*

Associated Masterformat Sections: 48 18 00

[See [D5010.10](#)]

### D5010.60 21-04 5010 60 Power Filtering and Conditioning TBD

### D5010.70 21-04 50 10 70 Transfer Switches

*Includes: Switches that transfer from one source of electricity to another.*

Associated Masterformat Sections: 26 36 00

[See [D5010.10](#)]

### D5010.90 21-05 50 10 90 Facility Power Generation Supplementary Components TBD

## D5020 21-04 50 20 Electrical Service and Distribution

*Includes: Electrical Service and Distribution Supplementary Components as appropriate.*

Associated Masterformat Sections: 01 86 26

100	See <a href="#">D50</a>	
200	Schematic layout with approximate size, shape, and location of equipment;	

### D5020.10 21-04 50 20 10 Electrical Service Entrance

*Includes: Meters, substations, transformers, switchgear, switchboards, and protective devices where electrical power enters structure.*

Associated Masterformat Sections: 26 21 00 / 26 16 00 / 26 11 00 / 26 12 00 / 26 22 00 / 26 13 00 / 22 23 00 / 26 18 00 / 22 28 00

100	See <a href="#">D50</a>	
200	See <a href="#">D5020</a>	
300	Modeled as design-specified size, shape, spacing, and location of equipment and associated components; approximate allowances for spacing and clearances required for all specified supports and seismic control; access/code clearance requirements modeled.	

# Unifomat Omniclass

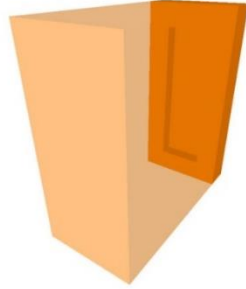
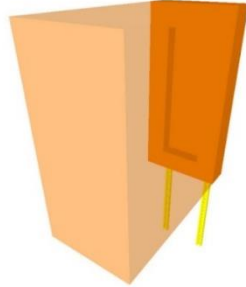
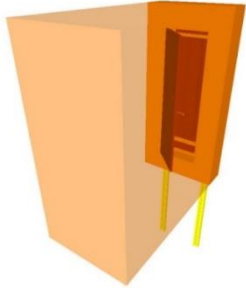
		 <p><i>197 D5020.10-LOD-300 Electrical Service Entrance</i></p>
350	<p>Modeled as actual size, shape, spacing, and location of equipment and associated components;</p> <p>actual size, shape, spacing, and location for supports and seismic control;</p> <p>actual size, shape, and location/connections of equipment and support structure/pads.</p> <p>actual access/code clearance requirements modeled.</p>	 <p><i>198 D5020.10-LOD-350 Electrical Service Entrance</i></p>
400	<p>Supplementary components added to the model required for fabrication and field installation.</p>	 <p><i>199 D5020.10-LOD-400 Electrical Service Entrance</i></p>

## D5020.30 21-04 50 20 30 Power Distribution

*Includes: Bus assemblies, distribution equipment, and electrical wiring system to distribute electrical power to switchboards, panelboards, and motor control centers.*

Associated Masterformat Sections: 26 20 00 / 26 24 00 / 26 24 13 / 26 24 16 / 26 24 19 / 26 25 00 / 26 27 00 / 26 27 16 / 26 05 33 / 26 05 43 / 26 05 36 / 26 05 13

100	See <a href="#">D50</a>	
200	See <a href="#">D5020</a>	

# Unifomat Omniclass

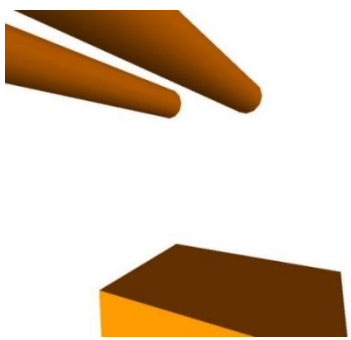
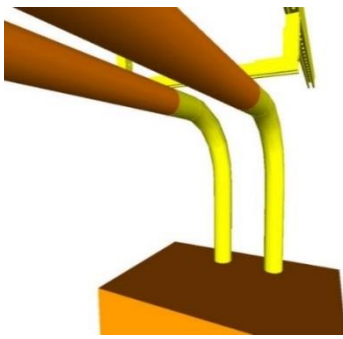
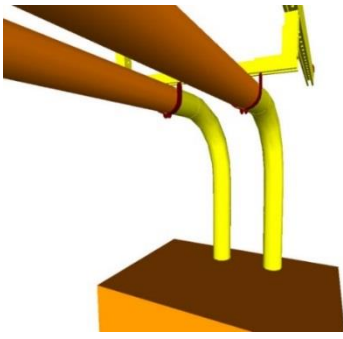
<p>300</p>	<p>Modeled as design-specified size, shape, spacing, and location of raceways, boxes, enclosures, and equipment; approximate allowances for spacing and clearances required for all specified hangers, supports and seismic control; access/code clearance requirements modeled.</p>	 <p>200 D5020.30-LOD-300 Power Distribution</p>
<p>350</p>	<p>Modeled as actual size, shape, spacing, and location of raceways, boxes, and enclosures; actual size, shape, spacing, and location for supports and seismic control; actual size, shape, and location/connections of equipment and support structure/pads; actual floor and wall penetration elements are modeled. actual access/code clearance requirements modeled.</p>	 <p>201 D5020.30-LOD-350 Power Distribution</p>
<p>400</p>	<p>Supplementary components added to the model required for fabrication and field installation.</p>	 <p>202 D5020.30-LOD-400 Power Distribution</p>

**D5020.70**      21-04 50 20 70      **Facility Grounding**  
Includes: Raceways, wiring and devices for grounding and bonding an electrical distribution system.  
Associated Masterformat Sections: 26 05 26 / 26 05 33 / 26 05 13

## Unifomat Omniclass

100	See <a href="#">D50</a>	
200	See <a href="#">D5020</a>	
300	Modeled as design-specified size, shape, spacing, and location of raceways, boxes, enclosures, and the electrical equipment and end-devices served;  approximate allowances for spacing and clearances required for all specified hangers, supports, and seismic control;  access/code clearance requirements modeled.	
350	Modeled as actual size, shape, spacing, and location of raceways, boxes, enclosures, and the electrical equipment and end-devices served;  actual size, shape, spacing, and location for supports and seismic control;  actual floor and wall penetration elements are modeled.  actual access/code clearance requirements modeled.	
400	Supplementary components added to the model required for fabrication and field installation.	

D5020.90      21-04 50 20 90      Electrical Service and Distribution      TBD  
Supplementary Components

### D5030      21-04 50 30      General Purpose Electrical Power

*Includes: General Purpose Electrical Power Supplementary Components as appropriate.*

Associated Masterformat Sections: 01 86 26

100	See <a href="#">D50</a>	
200	Schematic layout with approximate size, shape, and location of equipment;	

### D5030.10      21-04 50 30 10      Branch Wiring System

*Includes: Raceways, ducts, cable trays, and wiring to deliver power from branch panelboards to the point of use.*

Associated Masterformat Sections: 26 05 33 / 26 05 43 / 26 05 36 / 26 05 19

100	See <a href="#">D50</a>	
200	See <a href="#">D5030</a>	
300	Modeled as design-specified size, shape, spacing, and location of raceways, boxes, and enclosures;  approximate allowances for spacing and clearances required for all specified hangers, supports and seismic control;  access/code clearance requirements modeled.	

## Unifomat Omniclass

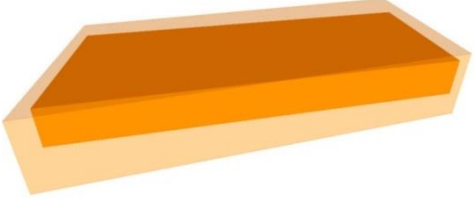
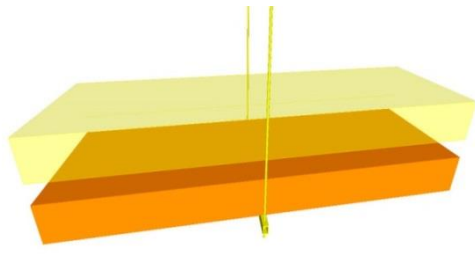
		 <p>203 D5030.10-LOD-300 Branch Wiring System</p>
350	<p>Modeled as actual size, shape, spacing, and location of raceways, boxes, enclosures;</p> <p>actual size, shape, spacing, and location for supports and seismic control;</p> <p>actual floor and wall penetration elements are modeled.</p> <p>actual access/code clearance requirements modeled.</p>	 <p>204 D5030.10-LOD-350 Branch Wiring System</p>
400	Supplementary components added to the model required for fabrication and field installation.	

### D5030.50 21-04 50 30 50 Wiring Devices

*Includes: Electrical devices at point of use including electrical outlets and switches.*

Associated Masterformat Sections: 26 27 26

100	See <a href="#">D50</a>	
200	See <a href="#">D5030</a>	
300	<p>Modeled as design-specified size, shape, spacing, and location of outlet boxes and devices;</p> <p>access/code clearance requirements modeled.</p>	
350	<p>Modeled as actual size, shape, spacing, and location of outlet boxes and devices.</p> <p>actual access/code clearance requirements modeled.</p>	
400	Supplementary components added to the model required for fabrication and field installation.	

## Unifomat Omniclass

D5030.90      21-04 50 30 90      General Purpose Electrical Power  
Supplementary Components      TBD

### D5040      21-04 50 40      Lighting

*Includes: Lighting Supplementary Components as appropriate.*

Associated Masterformat Sections: 26 50 00 / 01 86 26

100	See <a href="#">D50</a>	
200	Schematic layout with approximate size, shape, and location of equipment;	

### D5040.10      21-04 50 40 10      Lighting Control

*Includes: Clock and calendar, photoelectric switches, occupancy sensors, and light-leveling control devices.*

Associated Masterformat Sections: 26 09 23 / 26 09 26 / 26 09 33 / 26 09 36 / 26 09 43 / 26 09 61

100	See <a href="#">D50</a>	
200	See <a href="#">D5040</a>	
300	Modeled as design-specified size, shape, spacing, and location of enclosures, equipment, and devices; access/code clearance requirements modeled.	
350	Modeled as actual size, shape, spacing, and location of enclosures, equipment, and control devices; actual size, shape, and location/connections of equipment and control devices. actual access/code clearance requirements modeled.	
400	Supplementary components added to the model required for fabrication and field installation.	

### D5040.20      21-04 50 40 20      Branch Wiring for Lighting

*Includes: Raceways, ducts, cable trays, and wiring beyond branch circuit panelboards to lighting fixtures.*

Associated Masterformat Sections: 26 05 33 / 26 05 43 / 26 05 36 / 26 05 19 / 26 27 26

100	See <a href="#">D50</a>	
200	See <a href="#">D5040</a>	
300	Modeled as design-specified size, shape, spacing, and location of raceways, boxes, and enclosures to fixture locations; approximate allowances for spacing and clearances required for all specified hangers, supports, and seismic control.	



## Unifomat Omniclass

	access/code clearance requirements modeled.	
350	Modeled as actual size, shape, spacing, and location of raceways, boxes, and enclosures to fixture locations; actual size, shape, spacing, and location for supports and seismic control; actual floor and wall penetration elements are modeled. actual access/code clearance requirements modeled.	
400	Supplementary components added to the model required for fabrication and field installation.	

### D5040.50 21-04 50 40 50 Lighting Fixtures

*Includes: Luminaires, lighting equipment, ballasts, and accessories. Includes fluorescent, high intensity discharge, incandescent, mercury vapor, neon, and sodium vapor lighting.*

Associated Masterformat Sections: 26 50 00 / 26 51 00 / 26 52 00 / 26 53 00 / 26 54 00 / 26 55 00 / 26 55 23 / 26 55 29 / 26 55 33 / 26 55 36 / 26 55 39 / 26 55 53 / 26 55 59 / 26 55 61 / 26 55 63 / 26 55 70

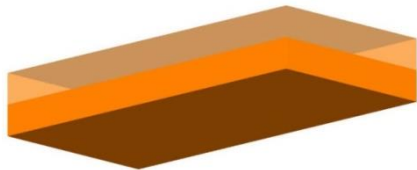
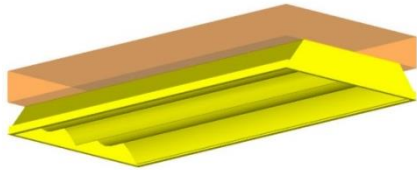
100	See <a href="#">D50</a>	
200	See <a href="#">D5040</a>	
300	Modeled as design-specified size, shape, spacing, and location of lighting fixtures; approximate allowances for spacing and clearances required for all specified hangers, supports and seismic control; access/code clearance requirements modeled.	 <p>205 D5040.50-LOD-300 Lighting Fixtures</p>
350	Modeled as actual size, shape, spacing, and location of lighting fixtures. actual size, shape, spacing, and location for supports and seismic control. actual access/code clearance requirements modeled.	 <p>206 D5040.50-LOD-350 Lighting Fixtures</p>
400	Supplementary components added to the model required for fabrication and field installation.	

## Unifomat Omniclass

D5040.90      21-04 50 40 90      Lighting Supplementary Components      TBD

### D5080      21-04 50 80      Miscellaneous Electrical Systems

*Includes: Miscellaneous Electrical Systems Supplementary Components as appropriate.*

Associated Masterformat Sections:

100	See <a href="#">D50</a>	
200	Schematic layout with approximate size, shape, and location of equipment;	

### D5080.10      21-04 50 80 10      Lightning Protection

*Includes: Wiring and equipment for lightning protection.*

Associated Masterformat Sections: 26 41 00 / 01 86 26 / 26 41 13 / 26 41 16 / 26 41 19 / 26 41 23

100	See <a href="#">D50</a>	
200	See <a href="#">D5080</a>	
300	Modeled as design-specified size, shape, spacing, and location of raceways, boxes, enclosures including the electrical equipment and end-devices served; approximate allowances for spacing and clearances required for all specified hangers, supports and seismic control; access/code clearance requirements modeled.	
350	Modeled as actual size, shape, spacing, and location of raceways, boxes, enclosures including the electrical equipment, fixtures, and end-devices served actual size, shape, spacing, and location for supports and seismic control; actual size, shape, and location/connections of equipment and support structure/pads; actual floor and wall penetration elements are modeled. actual access/code clearance requirements modeled.	
400	Supplementary components added to the model required for fabrication and field installation.	

D5080.40      21-04 50 80 40      Cathodic Protection      TBD

### D5080.70      21-04 50 80 70      Transient Voltage Suppression

*Includes: Devices to protect against voltage surges on electrical distribution systems.*

## Unifomat Omniclass

Associated Masterformat Sections: 26 43 00

100	See <a href="#">D50</a>	
200	See <a href="#">D5080</a>	
300	Modeled as design-specified size, shape, spacing, and location of equipment; approximate allowances for spacing and clearances required for all specified hangers, supports and seismic control; access/code clearance requirements modeled.	
350	Modeled as actual size, shape, spacing, and location of the equipment; actual size, shape, spacing, and location for supports and seismic control. actual access/code clearance requirements modeled.	
400	Supplementary components added to the model required for fabrication and field installation.	

D5080.90      21-04 50 80 90      Miscellaneous Electrical Systems Supplementary Components      TBD

### D60      21-04 60      Communications

Associated Masterformat Sections: 27 00 00 / 01 86 29

[See [Fundamental LOD Definitions](#)]

#### D6010      21-04 60 10      Data Communications

*Includes: Communications Supplementary Components as appropriate.*

Associated Masterformat Sections: 27 20 00 / 01 86 29

[See [Fundamental LOD Definitions](#)]

D6010.10      21-04 60 10 10      Data Communications Network Equipment      TBD

D6010.20      21-04 60 10 20      Data Communications Hardware      TBD

D6010.30      21-04 60 10 30      Data Communications Peripheral Data Equipment      TBD

#### D6020      21-04 60 20      Voice Communications

*Includes: Communications Supplementary Components as appropriate.*

Associated Masterformat Sections: 27 30 00 / 01 86 29

## Unifomat Omniclass

[See [Fundamental LOD Definitions](#)]

### D6030 21-04 60 30 Audio-Video Communication

*Includes: Communications Supplementary Components as appropriate.*

Associated Masterformat Sections: 27 40 00 / 01 86 29

[See [Fundamental LOD Definitions](#)]

### D6060 21-04 60 60 Distributed Communications and Monitoring

*Includes: Communications Supplementary Components as appropriate.*

Associated Masterformat Sections: 27 50 00 / 01 86 29

[See [Fundamental LOD Definitions](#)]

### D6090 21-04 60 90 Communications Supplementary Components

[See [Fundamental LOD Definitions](#)]

### D70 21-04 70 Electronic Safety and Security

Associated Masterformat Sections: 28 00 00 / 01 86 33

[See [Fundamental LOD Definitions](#)]

### D7010 21-04 70 10 Access Control and Intrusion Detection

*Includes: Electronic Safety and Security Supplementary Components as appropriate.*

Associated Masterformat Sections: 28 10 00 / 01 86 33

[See [Fundamental LOD Definitions](#)]

### D7030 21-04 70 30 Electronic Surveillance

*Includes: Equipment for detecting and controlling access by persons to a facility site, building, or within a building. Includes Electronic Safety and Security Supplementary Components as appropriate.*

Associated Masterformat Sections: 28 20 00 / 01 86 33

[See [Fundamental LOD Definitions](#)]

### D7050 21-04 70 50 Detection and Alarm

*Includes: Equipment for detecting hazardous conditions in a building or on a facility site and communicating an alarm signal. Includes alarm devices, detection devices, safety switches, and associated items. Includes Electronic Safety and Security Supplementary Components as appropriate.*

Associated Masterformat Sections: 28 30 00 / 01 86 33

### D7070 21-04 70 70 Electronic Monitoring and Control

*Includes: Electronic Safety and Security Supplementary Components as appropriate.*

[Back to TOC](#)



Copyright © 2017 by BIMForum. All rights reserved

This document is copyrighted under a [Creative Commons Attribution-NonCommercial-NoDerivatives 4.0 International License](#).

## Uniformat    Omniclass

Associated Masterformat Sections: 28 46 00 / 01 86 33

**D7090            21-04 70 90            Electronic Safety and Security Supplementary Components**

**These components are typically modeled as part of other assemblies listed in the tables above. Do not assign this Uniformat classification unless a supplementary component is modeled independently of another assembly.**

Associated Masterformat Sections:

**D80            21-04 80            Integrated Automation**

Associated Masterformat Sections: 25 00 00 / 01 86 23

[See [Fundamental LOD Definitions](#)]

**D8010            21-04 80 10            Integrated Automation Facility Controls**

*Includes: Hardware and/or software that allows the building automation system to monitor and control other facility equipment and systems. Includes Integrated Automation Supplementary Components as appropriate.*

Associated Masterformat Sections: 25 50 00 / 01 86 23

[See [Fundamental LOD Definitions](#)]

## Unifomat Omniclass

### **E 21-05 00 00 EQUIPMENT & FURNISHINGS**

Associated Masterformat Sections: 01 87 00

#### **E10 21-05 10 Equipment**

Associated Masterformat Sections: 11 00 00 / 01 87 13

100	Diagrammatic or schematic model elements: conceptual and/or schematic layout;  design performance parameters as defined in the BXP to be associated with model elements as non-graphic information.	
-----	--	--

#### **E1010 21-05 10 10 Vehicle and Pedestrian Equipment**

Associated Masterformat Sections: 11 10 00

100	See <a href="#">E10</a>	
200	Schematic layout with approximate size, shape, and location of equipment;  design performance parameters as defined in the BXP to be associated with model elements as non-graphic information.	

#### **E1010.10 21-05 10 10 10 Vehicle Servicing Equipment**

*Includes: Equipment associated with vehicle service facilities.*

Associated Masterformat Sections: 11 11 00 / 11 11 19 / 11 11 23 / 11 11 26

100	See <a href="#">E10</a>	
200	See <a href="#">E1010</a>	
300	Modeled as design-specified size, shape, spacing, and location of equipment and associated components;  approximate allowances for spacing and clearances required for all specified supports and seismic control;  access/code clearance requirements modeled.	
350	Modeled as actual size, shape, spacing, and location of equipment and associated components;  actual size, shape, spacing, and location for supports and seismic control;  actual size, shape, and location of service connections and support structure/pads.  Actual access/code clearance requirements modeled.	
400	Supplementary components added to the model required for fabrication and field installation.	

## Unifomat Omniclass

### E1010.30 21-05 10 10 30 Interior Parking Control Equipment

*Includes: Equipment associated with the control of movement of vehicle parking.*

Associated Masterformat Sections: 11 12 00 / 11 12 13 / 11 12 16 / 11 12 23 / 11 12 26 / 11 12 33

[See [E1010.10](#)]

### E1010.50 21-05 10 10 50 Loading Dock Equipment

*Includes: Equipment for the protection of service docks and for the loading and unloading of service vehicles.*

Associated Masterformat Sections: 11 13 00 / 11 13 13 / 11 13 16 / 11 13 19.13 / 11 13 19.23 / 11 13 26

[See [E1010.10](#)]

### E1010.70 21-05 10 10 70 Interior Pedestrian Control Equipment

*Includes: Equipment associated with the control of movement of pedestrians.*

Associated Masterformat Sections: 11 14 00 / 11 14 13 / 11 14 16 / 11 14 26 / 11 14 43 / 11 14 53

[See [E1010.10](#)]

### E1030 21-05 10 30 Commercial Equipment

Associated Masterformat Sections: 11 20 00

[See [E1010](#)]

### E1030.10 21-05 10 30 10 Mercantile and Service Equipment

*Includes: Equipment used in retail and service stores.*

Associated Masterformat Sections: 11 21 00 / 11 21 13 / 11 21 23 / 11 21 33 / 11 21 43 / 11 21 53

[See [E1010.10](#)]

### E1030.20 21-05 10 30 20 Vault Equipment

*Includes: Equipment specifically designed for money or valuable material storage, including vault ventilators and specialized security equipment.*

Associated Masterformat Sections: 11 16 00 / 11 16 13 / 11 16 16 / 11 16 23

[See [E1010.10](#)]

### E1030.25 21-05 10 30 25 Teller and Service Equipment

*Includes: Equipment specifically designed for handling and transfer of money and other high-security items.*

Associated Masterformat Sections: 11 17 00 / 11 17 13 / 11 17 16 / 11 17 23 / 11 17 33 / 11 17 36

[See [E1010.10](#)]

## Unifomat Omniclass

### E1030.30 21-05 10 30 30 Refrigerated Display Equipment

*Includes: Display cases that include refrigeration.*

Associated Masterformat Sections: 11 22 00

[See [E1010.10](#)]

### E1030.35 21-05 10 30 35 Commercial Laundry and Dry Cleaning Equipment

*Includes: Equipment for commercial laundry and dry-cleaning operations including coin-operated equipment.*

Associated Masterformat Sections: 11 23 00 / 11 23 13 / 11 23 16 / 11 23 19 / 11 23 23 /  
11 23 26 / 11 23 33 / 11 23 43

[See [E1010.10](#)]

### E1030.40 Maintenance Equipment

*Includes: Built-in and free-standing equipment for building maintenance.*

Associated Masterformat Sections: 11 24 00 / 11 24 13 / 11 24 16 / 11 24 19 / 11 24 23.13

[See [E1010.10](#)]

### E1030.50 21-05 10 30 50 Hospitality Equipment

*Includes: Specialized equipment for the purpose of registering, admitting, and controlling rooms and other information at hotels, motels, hospitals, and other similar facilities.*

Associated Masterformat Sections: 11 25 00 / 11 25 13

[See [E1010.10](#)]

### E1030.55 21-05 10 30 55 Unit Kitchens

*Includes: Manufactured units incorporating plumbing fixtures, appliances, casework and countertops.*

Associated Masterformat Sections: 11 26 00

[See [E1010.10](#)]

### E1030.60 21-05 10 30 60 Photographic Processing Equipment

*Includes: Photographic film processing equipment and other products for darkroom use.*

Associated Masterformat Sections: 11 27 00 / 11 27 13 / 11 27 16

[See [E1010.10](#)]

### E1030.70 21-05 10 30 70 Postal, Packaging and Shipping Equipment

*Includes: Equipment for normal mailing, packaging, shipping, and delivery operations for professional, commercial, and institutional applications.*

Associated Masterformat Sections: 11 29 00 / 11 29 23 / 11 29 33 / 11 29 55 / 11 28 23

[See [E1010.10](#)]



## Unifomat Omniclass

### E1030.75 21-05 10 30 75 Office Equipment

*Includes: Computers, printers, copiers, drafting equipment, plotters, carto-stereographs, and other equipment used in offices.*

Associated Masterformat Sections: 11 28 00 / 11 28 13 / 11 28 16 / 11 28 19 / 11 28 23

[See [E1010.10](#)]

### E1030.80 21-05 10 30 80 Foodservice Equipment

*Includes: Equipment used for liquid and solid food storage, preparation, display, serving, and clean-up in commercial and institutional kitchens and bars.*

Associated Masterformat Sections: 11 40 00 / 11 41 00 / 11 41 13 / 11 41 23 / 11 41 26 /  
11 41 33 / 11 42 00 / 11 43 00 / 11 41 13 / 11 41 16 / 11 44 00 / 11 44 13 / 11 44 16 /  
11 46 00 / 11 46 13 / 11 46 16 / 11 46 19 / 11 47 00 / 11 48 00 / 11 48 13

[See [E1010.10](#)]

### E1040 21-05 10 40 Institutional Equipment

Associated Masterformat Sections: 11 50 00

[See [E1010](#)]

### E1040.10 21-05 10 40 10 Educational and Scientific Equipment

*Includes: Equipment associated with libraries, education facilities, laboratories, planetariums, observatories, and museums.*

Associated Masterformat Sections: 11 50 00 / 11 51 00 / 11 51 13 / 11 51 16 / 11 51 19 /  
11 51 23 / 11 52 00 / 11 52 13 / 11 52 16 / 11 52 19 / 11 53 00 / 11 53 13 / 11 53 16 /  
11 53 19 / 11 53 23 / 11 53 33 / 11 53 43 / 11 53 53 / 11 55 00 / 11 55 13 / 11 55 16 /  
11 56 00 / 11 56 13 / 11 57 00 / 11 59 00 / 11 95 00 / 11 95 13

[See [E1010.10](#)]

### E1040.20 21-05 10 40 20 Healthcare Equipment

*Includes: Specialized equipment for healthcare facilities for humans and animals. Includes film illuminators, fluoroscopes, hubbard tubs, radio isotopic equipment, and surgical equipment.*

Associated Masterformat Sections: 11 70 00 / 05 45 23 / 11 71 00 / 11 72 00 / 11 73 00 /  
11 74 00 / 11 75 00 / 11 76 00 / 11 77 00 / 11 78 00 / 11 78 13 / 11 78 16 / 11 78 19 /  
11 79 00

[See [E1010.10](#)]

### E1040.40 21-05 10 40 40 Religious Equipment

*Includes: Built-in and free-standing religious equipment, including baptistry and chancel fittings.*

Associated Masterformat Sections: 11 91 00 / 11 91 13

[See [E1010.10](#)]

### E1040.60 21-05 10 40 60 Security Equipment

*Includes: Equipment specifically designed for secure operations.*

Associated Masterformat Sections: 11 18 00 / 11 18 13 / 11 18 16 / 11 18 23

## Unifomat Omniclass

[See [E1010.10](#)]

### E1040.70 21-05 10 40 70 Detention Equipment

*Includes: Equipment specifically designed for detention facilities.*

Associated Masterformat Sections: 11 19 00 / 01 87 13 / 11 19 13 / 11 19 16

[See [E1010.10](#)]

### E1060 21-05 10 60 Residential Equipment

*Includes: Built-in and free-standing appliances and other components specifically for residential use.*

Associated Masterformat Sections: 11 30 00

[See [E1010](#)]

### E1060.10 21-05 10 60 10 Residential Appliances

Associated Masterformat Sections: 11 31 00 / 11 31 13 / 11 31 23

[See [E1010.10](#)]

### E1060.50 21-05 10 60 50 Residential Stairs

Associated Masterformat Sections: 11 33 00

[See [B1080](#)]

### E1060.70 21-05 10 60 70 Residential Ceiling Fans

Associated Masterformat Sections: 11 34 00

[See [E1010.10](#)]

### E1070 21-05 10 70 Entertainment and Recreational Equipment

*Includes: Equipment for use in athletic, recreational, and therapeutic activities.*

Associated Masterformat Sections:

[See [E1010](#)]

### E1070.10 21-05 10 70 10 Theater and Stage Equipment

*Includes: Equipment for support of theatrical, instrumental, and voice programs. Includes cycloramas, entertainment ticket dispensers, scenery and flats, and tormentors.*

Associated Masterformat Sections: 11 61 00 / 11 61 13 / 11 61 23 / 11 61 33 / 11 61 43

[See [E1010.10](#)]

### E1070.20 21-05 10 70 20 Musical Equipment

*Includes: Musical instruments, including prefabricated and field assembled instruments.*

Associated Masterformat Sections: 11 62 00 / 11 62 13 / 11 62 16 / 11 62 19

[See [E1010.10](#)]

[Back to TOC](#)



## Unifomat Omniclass

### E1070.50 21-05 10 70 50 Athletic Equipment

*Includes: Equipment for use in interior athletic and exercise activities.*

Associated Masterformat Sections: 11 66 00 / 11 66 13 / 11 66 23 / 11 66 43 / 11 66 53

[See [E1010.10](#)]

### E1070.60 21-05 10 70 60 Recreational Equipment

*Includes: Equipment for use in recreational activities. Includes curling rinks and pistol and rifle range equipment.*

Associated Masterformat Sections: 11 67 00 / 11 67 13 / 11 67 23 / 11 67 33 / 11 67 43 / 11 67 53

[See [E1010.10](#)]

### E1090 21-05 10 90 Other Equipment

Associated Masterformat Sections: 11 90 00

[See [E1010](#)]

### E1090.10 21-05 10 90 10 Solid Waste Handling Equipment

*Includes: Equipment involving the collection, shredding, compaction, removal and incineration of trash and other solid waste*

Associated Masterformat Sections: 11 82 00 / 01 87 13 / 11 82 13 / 11 82 19 / 11 82 23 / 11 82 26 / 11 82 29 / 11 82 33 / 11 82 36

[See [E1010.10](#)]

### E1090.30 21-05 10 90 30 Agricultural Equipment

*Includes: Equipment related to land cultivating, raising crops, and feeding, breeding, and raising of livestock.*

Associated Masterformat Sections: 11 92 00 / 11 92 13 / 11 92 16 / 11 92 19 / 11 92 23

[See [E1010.10](#)]

### E1090.40 21-05 10 90 40 Horticultural Equipment

*Includes: Equipment related to cultivating flowers, fruits, vegetables, or ornamental plants.*

Associated Masterformat Sections: 11 93 00 / 11 93 13 / 11 93 16 / 11 93 19 / 11 93 23 / 11 93 26 / 11 93 29 / 11 93 33 / 32 86 00

[See [E1010.10](#)]

### E1090.60 21-05 10 90 60 Decontamination Equipment

*Includes: Equipment associated with decontamination operations.*

Associated Masterformat Sections:

[See [E1010.10](#)]

## E20 21-05 20 Furnishings

Associated Masterformat Sections: 12 00 00 / 01 87 16

## Unifomat Omniclass

100	A schematic model element or symbol that is not distinguishable by type or material. Types, layouts, and locations are still flexible.	
-----	---	--

### E2010 21-05 20 10 Fixed Furnishings

Associated Masterformat Sections:

100	See <a href="#">E20</a>	
200	Generic model elements with approximate nominal size. Placement and quantity remains flexible. •	

### E2010.10 21-05 20 10 10 Fixed Art

*Includes: Interior and exterior fixed art objects.*

Associated Masterformat Sections: 12 10 00 / 12 11 00 / 12 12 00 / 12 12 23 / 12 12 26 / 12 14 00 / 12 17 00 / 12 19 00

100	See <a href="#">E20</a>	
200	See <a href="#">E2010</a>	
300	Modeled types with specific dimensions, locations, and quantities.	
350	Include any applicable service or installation clearances. Include any applicable support and connection points.	
400	Supplementary components added to the model required for fabrication and field installation.	

### E2010.20 21-05 20 10 20 Window Treatments

*Includes: Interior window coverings and associated hardware and controls.*

Associated Masterformat Sections: 12 20 00 / 12 21 00 / 12 22 00 / 12 23 00 / 12 24 00 / 12 25 00

[See [E2010.10](#)]

### E2010.30 21-05 20 10 30 Casework

*Includes: Custom and manufactured stock design steel, wood, and laminate faced cabinets and other casework units. Includes countertops with integral sinks, fixtures and accessories.*

Associated Masterformat Sections: 12 30 00 / 12 35 00 / 12 35 17 / 12 35 25 / 12 35 30 / 12 35 33 / 12 35 50 / 12 35 53 / 12 35 59 / 12 35 70 / 12 35 91 / 12 36 00

[See [E2010.10](#)]

## Unifomat Omniclass

### E2010.70 21-05 20 10 70 Fixed Multiple Seating

*Includes: Fixed, and telescoping seating for theaters, auditoriums, lecture halls, stadiums, arenas, gymnasiums, religious buildings, restaurants, and other facilities where multiple seating is required.*

Associated Masterformat Sections: 12 60 00 / 12 61 00 / 12 63 00 / 13 34 16.53 / 12 64 00 / 12 65 00 / 12 66 00 / 12 67 00 / 12 68 00

[See [E2010.10](#)]

### E2010.90 21-05 20 10 90 Other Fixed Furnishings

*Includes: Fixed artificial plants, planters, and accessories.*

Associated Masterformat Sections: 12 90 00 / 12 92 00 / 12 92 13 / 12 92 33 / 12 92 43

[See [E2010.10](#)]

### E2050 21-05 20 50 Movable Furnishings

*Includes: Items of moveable furniture and furnishing accessories. Includes furniture for a variety of uses including classroom, dormitory, ecclesiastical, hotel and motel, laboratory, library, lounge, medical, office, restaurant, and residential.*

Associated Masterformat Sections:

[See [E2010](#)]

### E2050.10 21-05 20 50 10 Movable Art

*Includes: Interior and exterior moveable art objects such as paintings, and sculpture.*

Associated Masterformat Sections: 12 10 00 / 12 14 00 / 12 19 00

[See [E2010.10](#)]

### E2050.30 21-05 20 50 30 Furniture

*Includes: Movable interior furniture.*

Associated Masterformat Sections: 12 50 00 / 12 51 00 / 12 52 00 / 12 52 23 / 12 52 70 / 12 53 00 / 12 54 00 / 12 54 13 / 12 54 16 / 12 55 00 / 12 56 00 / 12 56 33 / 12 56 39 / 12 56 43 / 12 56 51 / 12 56 52 / 12 56 53 / 12 56 70 / 12 57 00 / 12 57 13 / 12 57 16 / 12 58 00 / 12 59 00

[See [E2010.10](#)]

### E2050.40 21-05 20 50 40 Accessories

*Includes: Interior furnishing accessories not attached to permanent construction.*

Associated Masterformat Sections: 12 40 00 / 12 41 00 / 12 42 00 / 12 43 00 / 12 44 00 / 12 44 16 / 12 45 00 / 12 46 00 / 12 48 00

[See [E2010.10](#)]

### E2050.60 21-05 20 50 60 Movable Multiple Seating

*Includes: Portable seating for auditoriums, lecture halls, stadiums, arenas, gymnasiums, religious buildings, restaurants, and other facilities where multiple seating is required.*

Associated Masterformat Sections: 12 60 00 / 12 62 00 / 12 65 00 / 12 67 00 / 12 68 00

[See [E2010.10](#)]

## Uniformat Omniclass

E2050.90      21-05 20 50 90      Other Movable Furnishings

*Includes: Moveable artificial plants, and planters.*

Associated Masterformat Sections: 12 90 00 / 12 92 00 / 12 92 13 / 12 92 33 / 12 92 43

[See [E2010.10](#)]



Uniformat Omniclass

**F 21-06 00 00 SPECIAL CONSTRUCTION & DEMOLITION**

Associated Masterformat Sections:

**F10 21-06 10 Special Construction**

Associated Masterformat Sections: 01 88 13

**F1010 21-06 10 10 Integrated Construction**

Associated Masterformat Sections:

[See [Fundamental LOD Definitions](#)]

**F1020 21-06 10 20 Special Structures**

Associated Masterformat Sections: 13 30 00 / 01 88 13

[See [Fundamental LOD Definitions](#)]

**F1020.40 21-06 10 20 40 Special Structures: Metal Building Systems**

*Includes: Prefabricated buildings and structures assembled on temporary and permanent foundations.*

Associated Masterformat Sections: 13 34 00 / 01 88 13 / 13 34 13 / 13 34 16 / 13 34 19 / 13 34 56

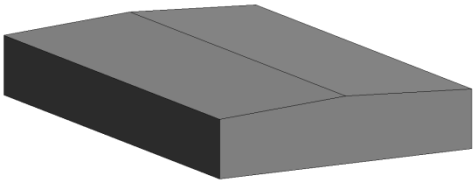
100	Generic mass of special structure with system typically noted with a design narrative for conceptual pricing.	 <p><i>207 F1020.40-LOD 100 Metal Building Systems</i></p>
-----	---	--

**F1020.40.10 21-06 10 20 40 Special Structures: Metal Building Systems - Primary Framing and Bracing**

*Includes: Prefabricated buildings and structures assembled on temporary and permanent foundations.*

Associated Masterformat Sections: 13 34 00 / 01 88 13 / 13 34 13 / 13 34 16 / 13 34 19 / 13 34 56

# Unifomat Omniclass

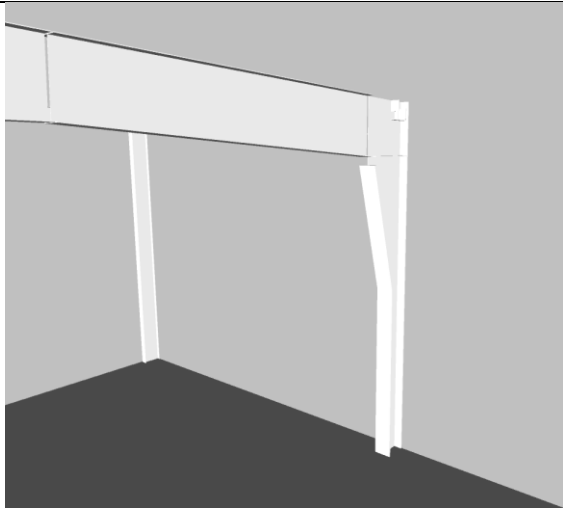
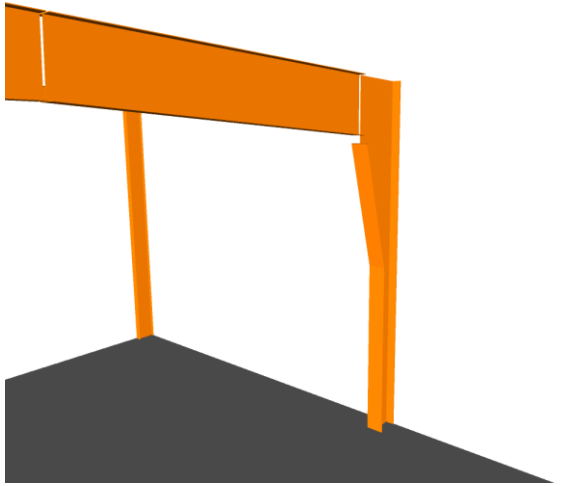
<p>200</p>	<p>Generic mass of frame shown in an approximate location, and a general span/direction with a design narrative for conceptual pricing.</p> <p>Model elements to include:</p> <ul style="list-style-type: none"> <li>• Framing grids defined.</li> <li>• Sections shapes shown but profiles, tapers and plate thicknesses and flange widths still flexible.</li> <li>• Primary braced bay locations</li> <li>• End wall framing type (i.e., main frame versus post and beam)</li> </ul> <p>Crane runways</p>	 <p><i>208 F1020.40-LOD 200 Metal Building Systems - Primary Framing</i></p>
<p>300</p>	<p>Metal Building System components including:</p> <ol style="list-style-type: none"> <li>1) Endwall or wind column</li> <li>2) End frame main members</li> <li>3) Module or interior columns</li> <li>4) Frames and main members             <ol style="list-style-type: none"> <li>a. Columns</li> <li>b. Rafters</li> </ol> </li> <li>5) Roof and wall diagonal bracing</li> <li>6) Crane beams</li> </ol> <p>Element modeling to include:</p> <ul style="list-style-type: none"> <li>• Specific sizes of frame structural members, all with correct orientation</li> <li>• Web tapers</li> <li>• Frame connection type (Extended/Flush)</li> <li>• Any lateral bracing components connecting to frame or foundation (i.e., portal frames, fixed base columns, diagonal bracing - rods or cables, struts) all with specific sizes and orientation.</li> </ul>	 <p><i>209 F1020.40-LOD 300 Metal Building Systems - Primary Framing</i></p>

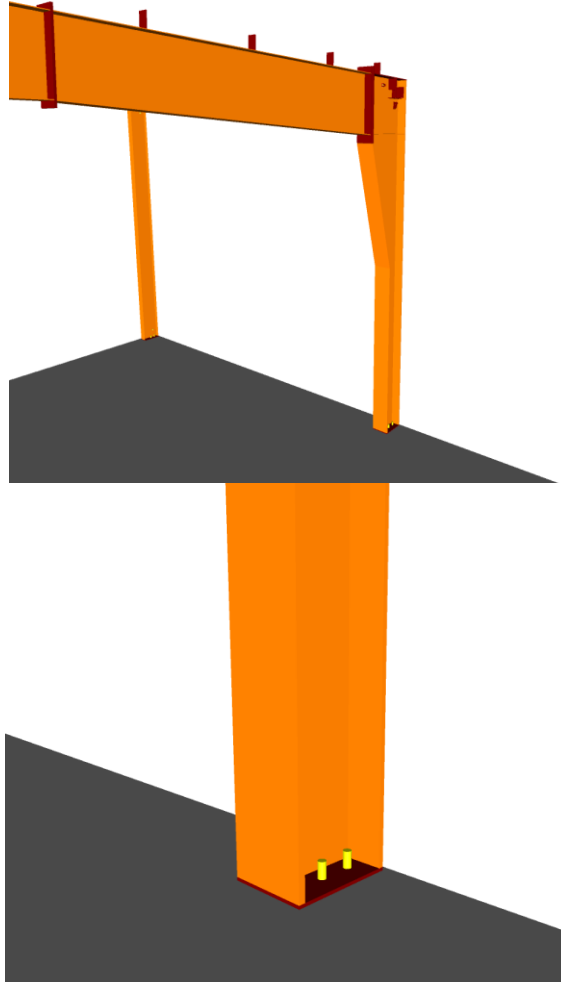

## Unifomat Omniclass

350	<p>Element modeling to include:</p> <ul style="list-style-type: none"><li>• Base plate locations</li><li>• Bracing components (i.e. gussets)</li><li>• Critical or large elements of connections applied to all structural steel connections such as base plates, gusset plates, anchor rods, etc.</li><li>• Clips required for connection to secondary framing</li><li>• Any miscellaneous steel members with correct size, shape, orientation and material required for the frame structure. (i.e., roof beams, spandrels)</li><li>• Any steel structure reinforcement such as web stiffeners, connection plate stiffeners, sleeve penetrations, etc. required for coordination.</li></ul>	 <p>210 F1020.40-LOD 350 Metal Building Systems - Primary Framing</p>
-----	--	--

# Unifomat Omniclass

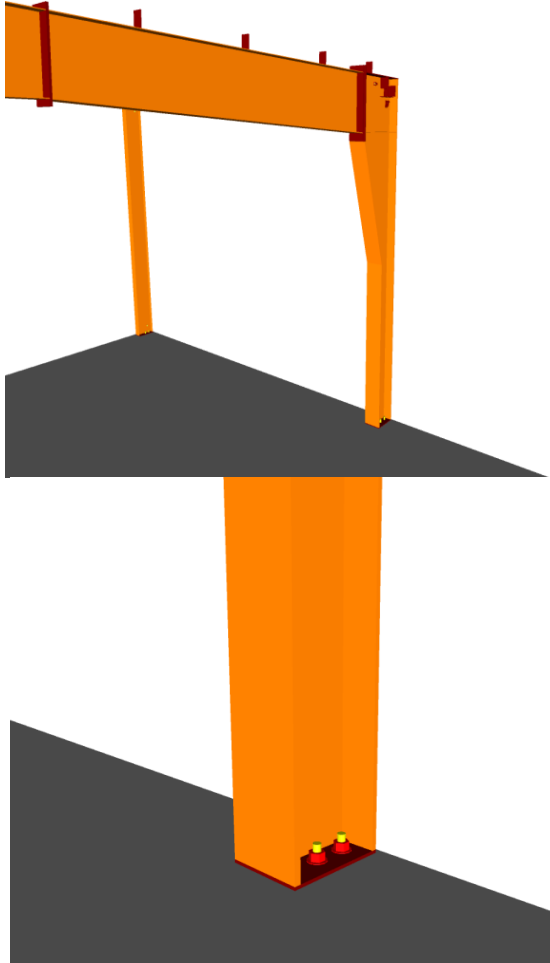
400	<p>Element modeling to include fabrication level information:</p> <ul style="list-style-type: none"><li>• Welds</li><li>• Reinforcement plates</li><li>• Coping of members</li><li>• Bolts, nuts, washers, etc.</li><li>• Holes, slots, etc., including holes for future element attachments</li><li>• All assembly elements</li></ul>	 <p>211 F1020.40-LOD 400 Metal Building Systems - Primary Framing</p>
-----	--	--

F1020.40.20      21-06 10 20 40      Special Structures: Metal Building Systems - Secondary Framing

*Includes: Prefabricated buildings and structures assembled on temporary and permanent foundations.*

Associated Masterformat Sections: 13 34 00 / 01 88 13 / 13 34 13 / 13 34 16 / 13 34 19 / 13 34 56

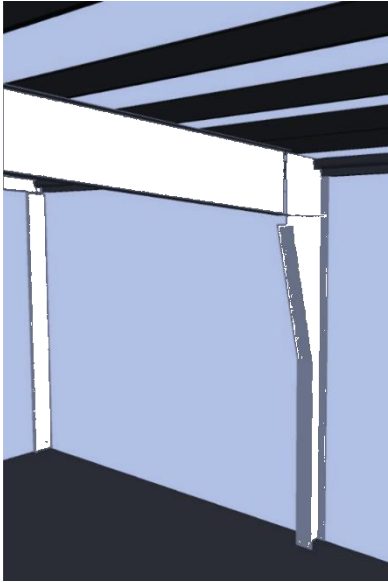
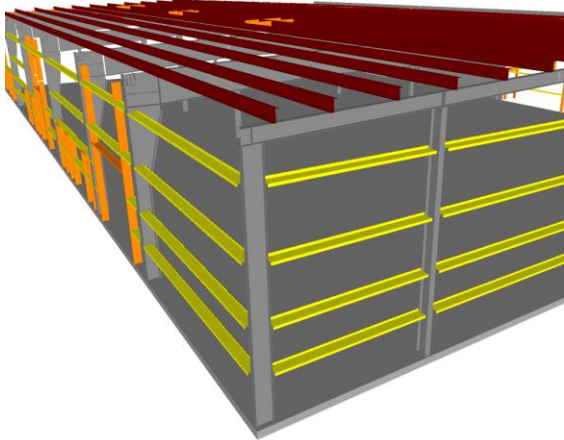

# Uniformat Omniclass

<p>200</p>	<p>Generic mass of special structure with system typically noted with a design narrative for conceptual pricing. Generic open wall conditions identified (i.e., open for material by others, open for passage, etc.)</p> <p>Approximate overall depth and extent represented by secondary roof and wall framing members.</p>	 <p><i>212 F1020.40-LOD 200 Metal Building Systems - Secondary Framing</i></p>
<p>300</p>	<p>Metal Building System components, including:</p> <ul style="list-style-type: none"> <li>• Purlins and bridging</li> <li>• Eave strut</li> <li>• Sidewall girts</li> <li>• Endwall girts</li> <li>• Sag braces</li> <li>• Framed openings (jambes, headers, etc.)</li> <li>• Window sub-frames</li> <li>• Walk door sub-frames</li> <li>• Wall member connection type (Flush/Bypass/Inset)</li> <li>• Base condition (i.e., angle, channel, tube)</li> </ul> <p>Element modeling to include:</p> <ul style="list-style-type: none"> <li>• Specific sizes of main structural members, (mass for open web members), all with correct orientation</li> </ul>	 <p><i>213 F1020.40-LOD 300 Metal Building Systems - Secondary Framing</i></p>

# Unifomat Omniclass

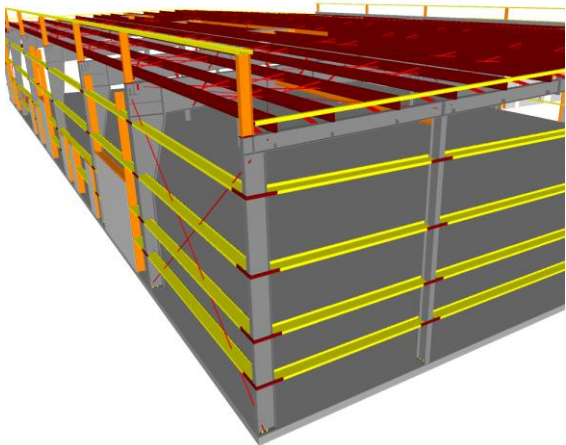
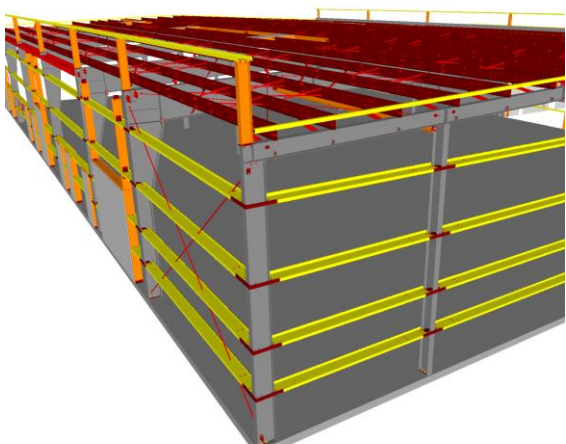
<p>350</p>	<p>Element modeling to include:</p> <ul style="list-style-type: none"> <li>• Nested members</li> <li>• Connections for member bracing</li> <li>• Clips joining secondary framing members</li> <li>• Large elements of typical connections applied to all secondary steel connections such as girt to column, purlin to rafter, jamb to girt, header to jamb, etc.</li> <li>• Secondary angles, including sheeting angles and rake angles</li> <li>• Base attachment members</li> <li>• Any miscellaneous secondary steel members with correct orientation, i.e. canopies, parapets, door framing, etc.</li> <li>• Web members and bridging for open web purlins</li> <li>• For bar joist, see Steel Open Web Joists LOD.</li> </ul>	 <p>214 F1020.40-LOD 350 Metal Building Systems-Secondary Framing</p>
<p>400</p>	<p>Element modeling to include fabrication level information:</p> <ul style="list-style-type: none"> <li>• Welds</li> <li>• Bolts, nuts, washers, screws, and fasteners</li> <li>• Coping of members</li> <li>• Holes cut for bracing</li> <li>• Nested member attachments</li> <li>• All assembly elements</li> <li>• Continuous web vs. open web</li> </ul>	 <p>215 F1020.40-LOD 400 Metal Building Systems - Secondary Framing</p>

F1020.40.30      21-06 10 20 40      **Special Structures: Metal Building Systems - Cladding and Exterior Trim**

*Includes: Prefabricated buildings and structures assembled on temporary and permanent foundations.*

Associated Masterformat Sections: 13 34 00 / 01 88 13 / 13 34 13 / 13 34 16 / 13 34 19 / 13 34 56

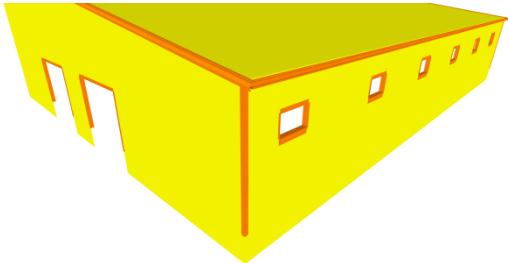
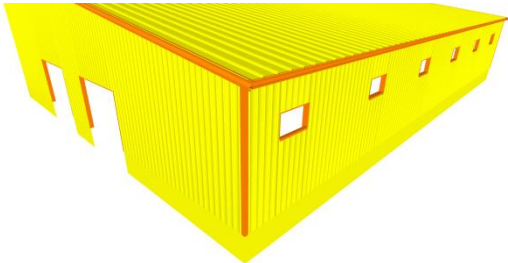

## Unifomat Omniclass

<p>200</p>	<p>Element modeling to include:</p> <ol style="list-style-type: none"> <li>1) Panel:             <ol style="list-style-type: none"> <li>a. Generic mass of panel with a generic profile or graphical texture shown,</li> <li>b. Openings/Voids are represented, identifying cladding boundaries within the wall/roof plane.</li> </ol> </li> <li>2) Trim:             <ol style="list-style-type: none"> <li>a. Major exterior trim used to separate roof and walls and trim used for aesthetic accent, represented by a generic trim profile.</li> </ol> </li> </ol>	 <p><i>216 F1020.40-LOD 200 Metal Building Systems – Cladding and Exterior Trim</i></p>
<p>300</p>	<p>Element modeling to include:</p> <ul style="list-style-type: none"> <li>• Panel:             <ul style="list-style-type: none"> <li>○ Panel with actual profile or graphical texture shown, filling the boundary set by the plane object.</li> <li>○ Significant accessories (i.e., light transmitting panels, ridge vents, curbs) shown</li> <li>○ Openings/Voids are represented in true dimensions/locations.</li> </ul> </li> <li>• Trim:             <ul style="list-style-type: none"> <li>○ Major trims (primary exterior pieces) are shown, represented by the actual trim profile, thickness, and color.                 <ul style="list-style-type: none"> <li>▪ Gutters</li> <li>▪ Corner boxes</li> <li>▪ Corners</li> <li>▪ Open wall trim</li> <li>▪ Framed opening trim</li> </ul> </li> </ul> </li> </ul>	 <p><i>217 F1020.40-LOD 300 Metal Building Systems – Cladding and Exterior Trim</i></p>

# Unifomat Omniclass

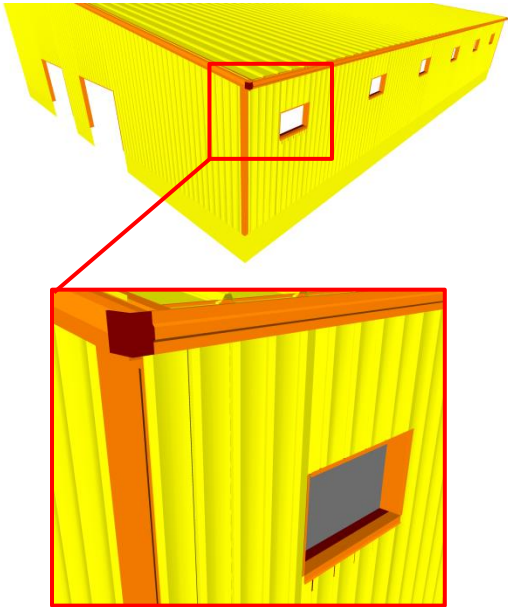
<p>350</p>	<p>Element modeling to include:</p> <ul style="list-style-type: none"><li>• Panel:<ul style="list-style-type: none"><li>○ Actual profile modeled filling the boundary set by the plane object.</li><li>○ Closures</li><li>○ Downspouts</li></ul></li><li>• Trim:<ul style="list-style-type: none"><li>○ Minor trims (end caps, transition pieces, etc.) are shown generically.</li></ul></li></ul> <p>Other non-graphic information may be included such as: Textual information on installation details</p>	 <p>218 F1020.40-LOD 350 Metal Building Systems – Cladding and Exterior Trim</p> <p>F1020.40-LOD 350 Metal Building Systems – Cladding and Exterior Trim</p>
------------	--	--

## Unifomat Omniclass

400	<p>Element modeling to include fabrication level information:</p> <ul style="list-style-type: none"> <li>• Panel: <ul style="list-style-type: none"> <li>○ Individual panel objects, with actual profile shown, positioned accurately within the building plane boundary and shown at installed length.</li> <li>○ Fasteners at critical locations</li> <li>○ Closures</li> <li>○ Cinch straps</li> <li>○ Caulk/mastic and other field-installed weather-tightness materials shown at critical locations</li> </ul> </li> <li>• Trim: <ul style="list-style-type: none"> <li>○ Minor trims (end caps, transition pieces, etc.) are shown accurately.</li> <li>○ Attachment or accessories (fasteners, etc.) shown at critical locations.</li> <li>○ Caulk/mastic and other field-installed weather-tightness materials shown at critical locations</li> </ul> </li> </ul> <p>Other non-graphic information may be included such as:  Additional material and its installation instructions required for proper installation  Mark identification that correlates with bill of material (i.e., piece mark)  Fastener material and installation instructions  Caulk/mastic and other field-installed weather-tightness materials and installation instructions</p>	
-----	--	--

### F1030                      21-06 10 30                      Special Function Construction

Associated Masterformat Sections:

[See [Fundamental LOD Definitions](#)]

### F1050                      21-06 10 50                      Special Facility Components

Associated Masterformat Sections:

[See [Fundamental LOD Definitions](#)]

### F1060                      21-06 10 60                      Athletic and Recreational Special Construction

*Includes: Special construction for athletic and recreational activities that are directly related to the adjacent construction.*

Associated Masterformat Sections: 13 28 00

[See [Fundamental LOD Definitions](#)]



## Uniformat Omniclass

### F1080 21-06 10 80 Special Instrumentation

*Includes: Instrumentation for measuring and recording phenomena such as stresses in structures, solar and wind energy, and effects of earthquakes.*

Associated Masterformat Sections: 13 50 00

[See [Fundamental LOD Definitions](#)]

### F20 21-06 20 Facility Remediation

Associated Masterformat Sections:

### F2010 21-06 20 10 Hazardous Materials Remediation

*Includes: Remediation for abatement and removal and disposal of contaminated materials within structures.*

Associated Masterformat Sections: 02 80 00

[See [Fundamental LOD Definitions](#)]

### F30 21-06 30 Demolition

Associated Masterformat Sections:

### F3010 21-06 30 10 Structure Demolition

*Includes: Complete removal and disposal of structures.*

Associated Masterformat Sections: 02 41 16

[See [Fundamental LOD Definitions](#)]

### F3030 21-06 30 30 Selective Demolition

*Includes: Removal and disposal of parts of structures.*

Associated Masterformat Sections: 02 41 19

[See [Fundamental LOD Definitions](#)]

### F3050 21-06 30 50 Structure Moving

*Includes: Preparation and processes of relocating and raising structures.*

Associated Masterformat Sections: 02 43 00

[See [Fundamental LOD Definitions](#)]

G 21-07 00 00 BUILDING SITEWORK

Associated Masterformat Sections: 01 89 00

### G10 21-07 10 Site Preparation

Associated Masterformat Sections: 01 89 13



## Uniformat Omniclass

100	A simple topographic surface is provided.	 <p>219 G10-LOD-100 Site Preparation</p>
200	<p>Element modeling to include:</p> <ul style="list-style-type: none"> <li>• Approximate size and shape of foundation element</li> <li>• Approximate size/location of utilities and structures</li> <li>• Approximate code and clearance requirements</li> <li>• Approximate pipe material</li> <li>• Rough modeling of site grading</li> </ul>	

### G1010 21-07 10 10 Site Clearing

*Includes: Removal of vegetation from the site, including stripping of sod and soil, and tree pruning for site clearing.*

Associated Masterformat Sections: 31 10 00 / 31 11 00 / 31 13 00 / 31 14 00 / 31 14 13 / 31 14 16

### G1020 21-07 10 20 Site Elements Demolition

*Includes: Removal of above and below grade site improvements.*

Associated Masterformat Sections: 02 41 13

### G1030 21-07 10 30 Site Element Relocations

*Includes: Relocation of utility systems.*

### G1050 21-07 10 50 Site Remediation

*Includes: Remediation of contaminated sites.*

Associated Masterformat Sections: 02 50 00 / 01 89

### G1070 21-07 10 70 Site Earthwork

*Includes: Moving earth to establish new contours and elevations.*

Associated Masterformat Sections: 31 20 00 / 01 89 13

### G1070.10 21-07 10 70 10 Grading

*Includes: Earthmoving to reshape contours.*

Associated Masterformat Sections: 31 20 00 / 01 89 13

[Back to TOC](#)



Copyright © 2017 by BIMForum. All rights reserved

This document is copyrighted under a [Creative Commons Attribution-NonCommercial-NoDerivatives 4.0 International License](#).

## Unifomat Omniclass

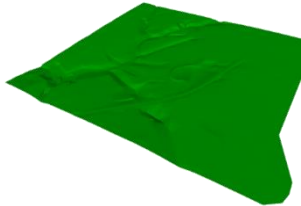
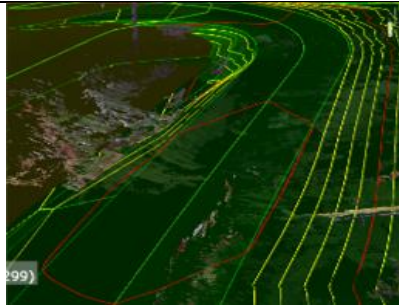
100	Proposed Surfaces shown as a plane.	
200	Proposed Surface: Generic Surface Interpolation between the following elements: Building Envelope at Finish Floor, Finish Grade at Retaining Walls, Grading Limits. Curbs, hardscape, finish surface at building envelopes.	
300	Proposed Surface: Complete and accurate surface definition based on defined fine grading, grade breaks, curbs, hardscape, buildings, swales, etc.  Local Coordinate Control. Shared Coordinate from Building Grid base point to real-world project control	
350	Include existing Surface: 3D surface generated from site topography, with grade breaks and lines as needed to define accurate surface. 3D site features included if provided by surveyor (i.e. walls, signage, stairs, etc., as defined in Survey LOC-Grade). Added definition from supplemental survey, revised limits of work	
400	Surface modeled to facilitate robotic controlled grading and GPS grade-control systems.	

G20

21-07 20

Site Improvements

Associated Masterformat Sections: 01 89 16

100	Diagrammatic or schematic model elements.	
-----	---	--

## Uniformat Omniclass

200	<p>Element modeling to include:</p> <ul style="list-style-type: none"> <li>• Approximate size and shape of foundation element</li> <li>• Approximate size/location of utilities and structures</li> <li>• Approximate code and clearance requirements</li> <li>• Rough modeling of site grading</li> <li>• Local structural building grids defined in model and coordinated with global state plane coordinate system for site model.</li> </ul>	
-----	--	--

### G2010 21-07 20 10 Roadways

*Includes: Pavement, curbs and gutters, appurtenances, lighting, and vehicle fare collection for roadways. May Include: Site earthwork.*

Associated Masterformat Sections: 01 89 16

[See [Fundamental LOD Definitions](#)]

### G2020 21-07 20 20 Parking Lots

*Includes: Pavement, curbs and gutters, appurtenances, lighting, and parking control equipment for parking lots. May Include: Site earthwork*

Associated Masterformat Sections: 01 89 16

[See [Fundamental LOD Definitions](#)]

#### G2020.10 21-07 20 20 10 Parking Lot Pavement

*Includes: Prepared and compacted soil and granular layers placed prior to installation of parking lot pavement. Includes: Finished parking lot pavement of granular and asphaltic materials. Includes: Finished parking lot pavement with high bending resistance, usually of concrete. Includes: Blocks or tiles used for parking lot pavement. Unit pavers set in mastic, sand, or mortar.*

Associated Masterformat Sections: 32 10 00 / 32 12 00 / 32 13 00 / 32 14 00 / 32 15 00

100	See <a href="#">G20</a>	
200	See <a href="#">G20</a>	
300	Specific thickness of pavement and substrate modeled. All drainage slopes modeled.	
350	Openings for drains and other services modeled.	

#### G2020.20 21-07 20 20 20 Parking Lot Curbs and Gutters

*Includes: Construction at perimeter of parking lot pavement to separate pavement from adjacent surfaces, provide vehicular restraint, and facilitate drainage.*

Associated Masterformat Sections: 32 16 13

100	See <a href="#">G20</a>	
200	See <a href="#">G20</a>	
300	Full extents of curbs and gutters (above and below grade) are modeled.	
350	<p>Element modeling to include:</p> <ul style="list-style-type: none"> <li>• Reinforcing</li> <li>• Pour stops</li> <li>• Expansion joints</li> </ul>	

## Uniformat Omniclass

### G2020.40 21-07 20 20 40 Parking Lot Appurtenances

*Includes traffic signals, signage, striping.*

Associated Masterformat Sections: 32 17 00 / 32 17 13 / 32 17 43 / 10 14 53 / 32 17 23

### G2030 21-07 20 30 Pedestrian Plazas and Walkways

*Includes: Pavement, curbs and gutters, appurtenances, lighting, and pedestrian control equipment for pedestrian plazas and walkways. Includes exterior steps and ramps. May Include: Site earthwork.*

Associated Masterformat Sections: 01 89 16

### G2040 21-07 20 40 Airfields

*Includes: Pavement, curbs and gutters, appurtenances, lighting, and airfield signally and control equipment for airfields. May Include: Site earthwork.*

Associated Masterformat Sections: 01 89 16

### G2050 21-07 20 50 Athletic, Recreational, and Playfield Areas

*Includes: Surfacing, fencing, equipment, grandstands and bleachers, and lighting for athletic, recreational, and playfield areas. May Include: Site earthwork.*

Associated Masterformat Sections: 01 89 16

### G2060 21-07 20 60 Site Development

[See [Fundamental LOD Definitions](#)]

### G2080 21-07 20 80 Landscaping

[See [Fundamental LOD Definitions](#)]

*Includes: Trees*

Associated Masterformat Sections: 31 20 00 / 01 89 13

### G30 21-07 30 Liquid and Gas Site Utilities

Associated Masterformat Sections: 01 89 19

100	Narrative that references the grading model	
200	Approximate sizes, vertical control, and apparatus.	

## Unifomat Omniclass

### G3010 21-07 30 10 Water Utilities

*Includes: Water distribution for domestic consumption, fire fighting, and irrigation for a facility site and for multiple facilities. Includes trenching and backfilling. Includes Liquid and Gas Site Utilities Supplementary Components as appropriate.*

Associated Masterformat Sections: 33 10 00

100	See <a href="#">G30</a>	
200	See G30	

### G3010.10 21-07 30 10 10 Site Domestic Water Distribution

*Includes: Supply wells, piping, equipment, storage tanks, and water ponds and reservoirs.*

Associated Masterformat Sections: 01 89 19 / 33 21 00 / 33 11 00 / 33 12 00 / 33 12 13 / 33 12 16 / 33 12 19 / 33 12 23 / 33 12 33 / 33 13 00 / 33 16 00 / 33 47 19.13 / 33 47 13.13 / 33 47 16.13

100	See <a href="#">G30</a>	
200	See G30	

### G3010.30 21-07 30 10 30 Site Fire Protection Water Distribution

*Includes: Supply wells, piping, equipment, storage tanks, and water ponds and reservoirs.*

Associated Masterformat Sections: 01 89 19 / 33 21 00 / 33 11 19 / 33 12 00 / 33 12 13 / 33 12 16 / 33 12 19 / 33 12 23 / 33 12 33 / 33 16 00 / 33 47 19.33 / 33 47 13.13 / 33 47 16.13

100	See <a href="#">G30</a>	
200	See G30	

### G3020 21-07 30 20 Sanitary Sewerage Utilities

*Includes: Sanitary sewerage for a facility site and for multiple facilities. Includes piping, septic tanks that serve multiple facilities, structures, and lagoons. Includes trenching and backfilling. Includes Liquid and Gas Site Utilities Supplementary Components as appropriate.*

Associated Masterformat Sections: 33 30 00 / 01 89 19

100	See <a href="#">G30</a>	
200	See G30	

### G3020.20 21-07 30 20 20 Sanitary Sewerage Piping

Associated Masterformat Sections: 33 31 00 / 33 33 00 / 33 34 00

100	See <a href="#">G30</a>	
200	See G30	
300	Specific elevations, sizes, materials	

## Uniformat Omniclass

### G3020.50 21-07 30 20 50 Sanitary Sewerage Structures

Associated Masterformat Sections: 33 39 00 / 33 39 13 / 33 39 23

100	See <a href="#">G30</a>	
200	Approximate structure types, sizes and materials	
300	Specific structure elements at all locations, specific sizes and materials	

### G3030 21-07 30 30 Storm Drainage Utilities

*Includes: Storm drainage for surface or combination of surface and subsurface water for a facility site or for multiple facilities. Includes piping, culverts, water drains, drainage pumps, Subdrainage, and storm drainage ponds and reservoirs. Includes trenching and backfilling. Includes Liquid and Gas Site Utilities Supplementary Components as appropriate.*

Associated Masterformat Sections: 01 89 19

100	See <a href="#">G30</a>	
200	See G30	

### G3050 21-07 30 50 Site Energy Distribution

*Includes: Energy distribution for a facility site or multiple facilities. Includes hydronic heating, steam energy, and hydronic cooling distribution. Includes trenching and backfilling. Includes Liquid and Gas Site Utilities Supplementary Components as appropriate.*

100	See <a href="#">G30</a>	
200	See G30	

### G3060 21-07 30 60 Site Fuel Distribution

*Includes: Gas, fuel-oil, gasoline, diesel fuel, and aviation fuel distribution for a facility site or multiple facilities. Includes trenching and backfilling. Includes Liquid and Gas Site Utilities Supplementary Components as appropriate.*

100	See <a href="#">G30</a>	
200	See G30	

### G3090 21-07 30 90 Liquid and Gas Site Utilities Supplementary Components

*Includes: Common work results for utilities and instrumentation and control to be included in liquid and gas utility elements above as appropriate.*

***These components are typically modeled as part of other assemblies listed in the tables above. Do not assign this Uniformat classification unless a supplementary component is modeled independently of another assembly.***

### G40 21-07 40 Electrical Site Improvements

Associated Masterformat Sections: 01 89 26

## Unifomat Omniclass

100	<p>Diagrammatic or schematic model elements: conceptual and/or schematic layout; design performance parameters as defined in the BXP to be associated with model elements as non-graphic information.</p>	
-----	---	--

### G4010 21-07 40 10 Site Electric Distribution Systems

*Description: Electrical wiring systems to distribute electrical power to on the Site. Includes Duct Banks, Pullboxes, vaults and transformers from the utility point of connection, to the building's main electric room.*

Associated Masterformat Sections: 01 89 26

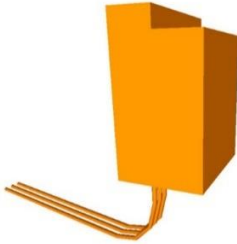
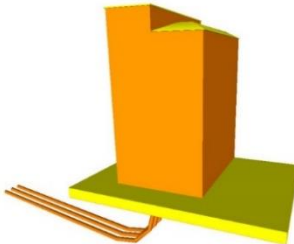
100	See <a href="#">G40</a>	
200	<p>Generic model elements in schematic layout with: approximate size, shape, and location of equipment; approximate access/code clearance requirements modeled; design performance parameters as defined in the BXP to be associated with model elements as non-graphic information.</p>	
300	<p>Modeled as design-specified size, shape, spacing, and location of raceways/ boxes/enclosures/duct banks in the power distribution system  specified size, shape, spacing, and location of equipment and associated components;  approximate allowances for spacing and clearances required for all specified hangers, supports and seismic control  access/code clearance requirements modeled</p>	 <p>220 G4010-LOD-300 Site Electric Distribution Systems</p>
350	<p>Modeled as actual size, shape, spacing, and location of raceways/ boxes/enclosures/duct banks in the power distribution system;  actual size, shape, spacing, and location for supports and seismic control;  actual size, shape, and location/connections of equipment and support structure/pads.  Actual access/code clearance requirements modeled</p>	 <p>221 G4010-LOD-350 Site Electric Distribution Systems</p>

## Unifomat Omniclass

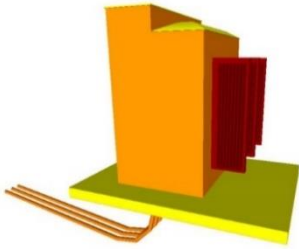
400	Supplementary components added to the model required for fabrication and field installation.	 <p>222 G4010-LOD-400 Site Electric Distribution Systems</p>
-----	--	---

### G4050 21-07 40 50 Site Lighting

*Description: Luminaires, lighting equipment, ballasts, and accessories. Includes fluorescent, high intensity discharge, incandescent, mercury vapor, neon, and sodium vapor lighting. Includes Pole Mount, Building Mount and on-grade fixtures for exterior lighting.*

Associated Masterformat Sections: 26 56 29

100	See <a href="#">G40</a>	
200	Generic elements in schematic layout with: approximate size, shape, and location of equipment; approximate access/code clearance requirements modeled; design performance parameters as defined in the BXP to be associated with model elements as non-graphic information.	
300	Modeled as design-specified size, shape, spacing, and location of lighting fixtures; approximate allowances for spacing and clearances required for all specified hangers, supports and seismic control; required pole bases and footing elements; access/code clearance requirements modeled.	
350	Modeled as actual size, shape, spacing, and location of lighting fixtures; actual size, shape, spacing, and location for supports and seismic control; actual size, shape, and location/connections of equipment and support structure/pads. Actual access/code clearance requirements modeled.	
400	Supplementary components added to the model required for fabrication and field installation.	

### G50 21-07 50 Site Communications

100	Diagrammatic or schematic model elements:	
-----	---	--



## Unifomat Omniclass

	conceptual and/or schematic layout; design performance parameters as defined in the BXP to be associated with model elements as non-graphic information.	
--	---	--

### G5010 – Site Communications Systems

*Description: Conduit Systems for routing of Communication trunk systems.*

Associated Masterformat Sections: 33 80 00

100	See <a href="#">G50</a>	
200	Generic elements in a schematic layout with: approximate size, shape, and location of equipment; approximate access/code clearance requirements modeled; design performance parameters as defined in the BXP to be associated with model elements as non-graphic information.	
300	Modeled as design-specified size, shape, spacing, and location of raceways, boxes, and enclosures in the power distribution system; size, shape, spacing, and location of equipment and associated components; approximate allowances for spacing and clearances required for all specified hangers, supports and seismic control; access/code clearance requirements modeled.	
350	Modeled as actual size, shape, spacing, and location of raceways, boxes, and enclosures in the power distribution system; size, shape, spacing, and location for supports and seismic control; size, shape, location, and connections of equipment and support structure or pads; floor and wall penetration elements are modeled. Actual access/code clearance requirements modeled.	
400	Supplementary components added to the model required for fabrication and field installation.	

### G90

21-07 90

### Miscellaneous Site Construction

Associated Masterformat Sections: 01 89 29

### G9010

21-07 90 10

### Tunnels

*Includes: Vehicular, pedestrian, and service tunnels. Includes tunnel boring, bracing and jacking work, linings and casing, grouting support systems, boring machines, and control and spoil removal systems. Includes Tunnel Construction Related Activities as appropriate.*

Associated Masterformat Sections: 31 70 00 / 01 89 29



## Unifomat Omniclass

[See [Fundamental LOD Definitions](#)]



Unifomat Omniclass

**N/A      23-13      STRUCTURAL AND EXTERIOR ENCLOSURE PRODUCTS**

N/A      23-13-23      Mechanical Fasteners, Adhesives, and Sealants

N/A      23-13 23 11      Mechanical Fasteners – L-Bolt  
*Includes: Cast-in anchors per American Concrete Institute 318 building code.*

Associated Masterformat Sections: N/A

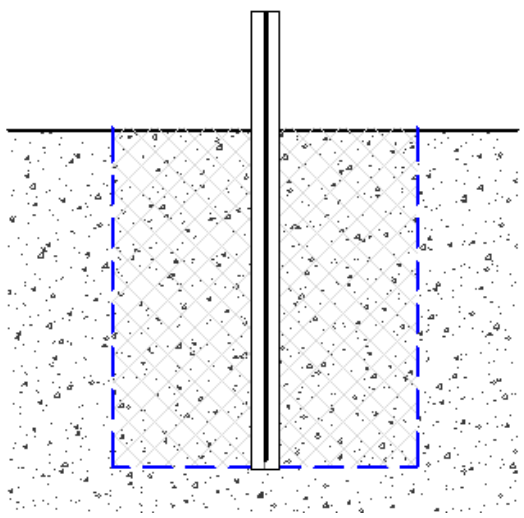
200	Refer to the model element of the main assembly being connected.	N/A
300	Refer to the model element of the main assembly being connected.	N/A
350	<p>Element modeling to include:</p> <ul style="list-style-type: none"> <li>• Anchor Length</li> <li>• Embedment Length</li> <li>• Projection Length</li> <li>• Edge Distance Zone</li> <li>• Spacing Zone</li> <li>• Geometry, base size without threads</li> </ul> <p>Required non-graphic information associated with model elements to include:</p> <ul style="list-style-type: none"> <li>• Anchor materials defined</li> <li>• Anchor type defined</li> <li>• Base material type (steel, concrete, masonry, etc)</li> <li>• Base material strength</li> <li>• Base material condition (New, existing, cracked, uncracked, saturated, etc.)</li> <li>• Finishes, i.e. primed, galvanized, etc.</li> </ul>	 <p><i>LOD 350 L-Bolt Anchor</i></p>

## Unifomat Omniclass

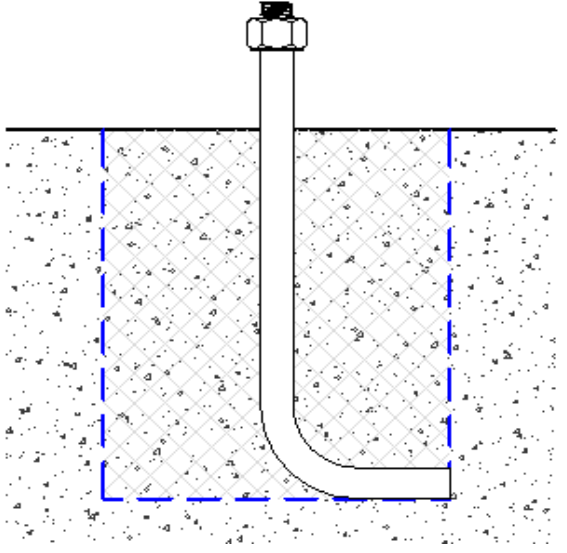
400	<p>Element modeling to include fabrication level information:</p> <ul style="list-style-type: none"><li>• Anchor Threads</li><li>• Anchor Washers</li><li>• Anchor Nuts</li></ul> <p>Other non-graphic information may be included such as:</p> <ul style="list-style-type: none"><li>• Mark identification that correlates with bill of material (i.e., piece mark)</li><li>• Member finish (primer, galvanized, etc.)</li><li>• Fastener finish (i.e., black, zinc electroplated, hot-dipped galvanized)</li></ul>	 <p><i>LOD 400 L-Bolt Anchor</i></p>
-----	--	--

# Unifomat Omniclass

## N/A 23-13 23 11 Mechanical Fasteners – J-Bolt

Includes: Cast-in anchors per American Concrete Institute 318 building code.

Associated Masterformat Sections: N/A

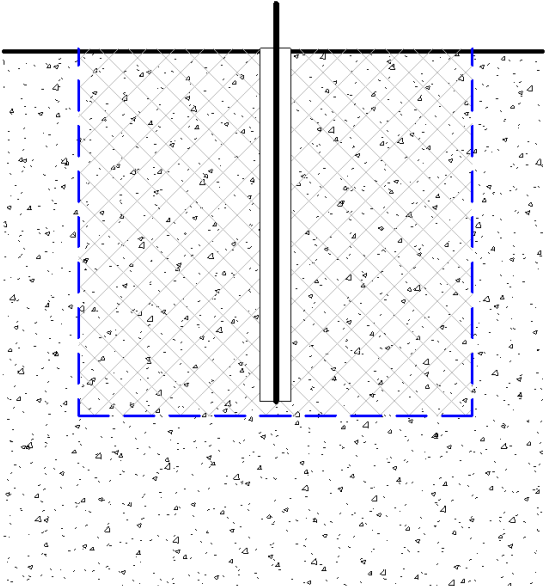
200	Refer to the model element of the main assembly being connected.	N/A
300	Refer to the model element of the main assembly being connected.	N/A
350	<p>Element modeling to include:</p> <ul style="list-style-type: none"> <li>• Anchor Length</li> <li>• Embedment Length</li> <li>• Projection Length</li> <li>• Edge Distance Zone</li> <li>• Spacing Zone</li> <li>• Geometry, base size without threads</li> </ul> <p>Required non-graphic information associated with model elements to include:</p> <ul style="list-style-type: none"> <li>• Anchor materials defined</li> <li>• Anchor type defined</li> <li>• Base material type (steel, concrete, masonry, etc)</li> <li>• Base material strength</li> <li>• Base material condition (New, existing, cracked, uncracked, saturated, etc.)</li> <li>• Finishes, i.e. primed, galvanized, etc.</li> </ul>	 <p>LOD 350 J-Bolt Anchor</p>

# Unifomat Omniclass

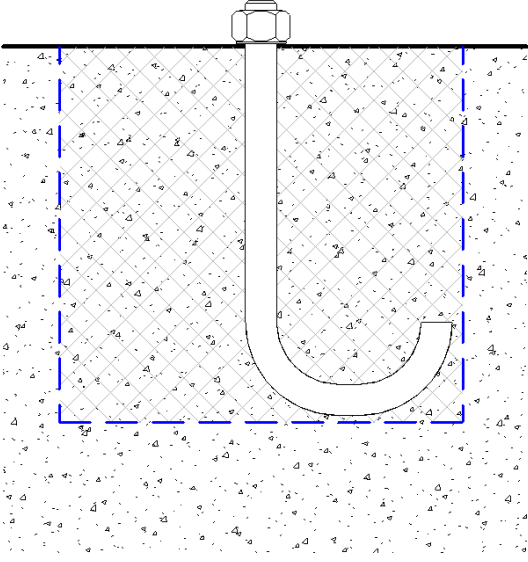
<p>400</p>	<p>Element modeling to include fabrication level information:</p> <ul style="list-style-type: none"> <li>• Anchor Threads</li> <li>• Anchor Washers</li> <li>• Anchor Nuts</li> </ul> <p>Other non-graphic information may be included such as:</p> <ul style="list-style-type: none"> <li>• Mark identification that correlates with bill of material (i.e., piece mark)</li> <li>• Member finish (primer, galvanized, etc.)</li> <li>• Fastener finish (i.e., black, zinc electroplated, hot-dipped galvanized)</li> </ul>	 <p>LOD 400 J-Bolt Anchor</p>
------------	--	---

## N/A 23-13 23 11 Mechanical Fasteners – Hex Head Bolt with Washer

Includes: Cast-in anchors per American Concrete Institute 318 building code.

Associated Masterformat Sections: N/A

<p>200</p>	<p>Refer to the model element of the main assembly being connected.</p>	<p>N/A</p>
<p>300</p>	<p>Refer to the model element of the main assembly being connected.</p>	<p>N/A</p>

# Unifomat Omniclass

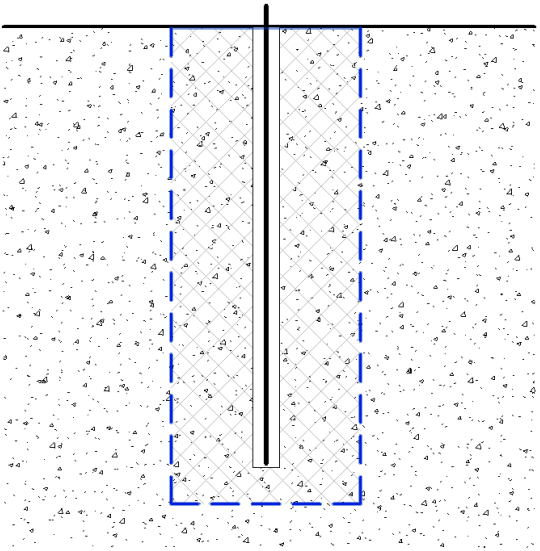
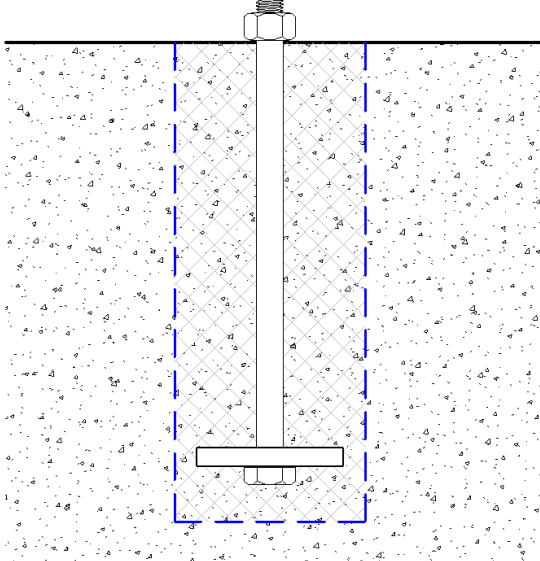
<p>350</p>	<p>Element modeling to include:</p> <ul style="list-style-type: none"> <li>• Anchor Length</li> <li>• Embedment Length</li> <li>• Projection Length</li> <li>• Edge Distance Zone</li> <li>• Spacing Zone</li> <li>• Geometry, base size without threads</li> </ul> <p>Required non-graphic information associated with model elements to include:</p> <ul style="list-style-type: none"> <li>• Anchor materials defined</li> <li>• Anchor type defined</li> <li>• Base material type (steel, concrete, masonry, etc)</li> <li>• Base material strength</li> <li>• Base material condition (New, existing, cracked, uncracked, saturated, etc.)</li> <li>• Finishes, i.e. primed, galvanized, etc.</li> </ul>	 <p><i>LOD 350 Hex Head Bolt with Washer</i></p>
<p>400</p>	<p>Element modeling to include fabrication level information:</p> <ul style="list-style-type: none"> <li>• Anchor Threads</li> <li>• Anchor Washers</li> <li>• Anchor Nuts</li> </ul> <p>Other non-graphic information may be included such as:</p> <ul style="list-style-type: none"> <li>• Mark identification that correlates with bill of material (i.e., piece mark)</li> <li>• Member finish (primer, galvanized, etc.)</li> <li>• Fastener finish (i.e., black, zinc electroplated, hot-dipped galvanized)</li> </ul>	 <p><i>LOD 400 Hex Head Bolt with Washer</i></p>

Unifomat Omniclass

N/A 23-13 23 11 Mechanical Fasteners – Welded Headed Stud Bolt

Includes: Cast-in anchors per American Concrete Institute 318 building code.

Associated Masterformat Sections: N/A

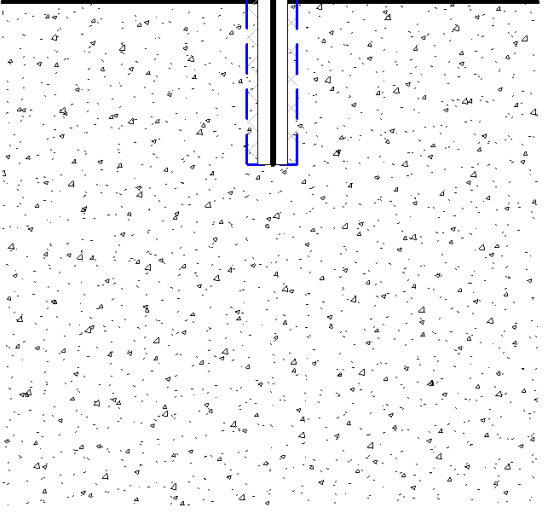
200	Refer to the model element of the main assembly being connected.	N/A
300	Refer to the model element of the main assembly being connected.	N/A
350	<p>Element modeling to include:</p> <ul style="list-style-type: none"> <li>• Anchor Length</li> <li>• Embedment Length</li> <li>• Projection Length</li> <li>• Edge Distance Zone</li> <li>• Spacing Zone</li> <li>• Geometry, base size without threads</li> </ul> <p>Required non-graphic information associated with model elements to include:</p> <ul style="list-style-type: none"> <li>• Anchor materials defined</li> <li>• Anchor type defined</li> <li>• Base material type (steel, concrete, masonry, etc)</li> <li>• Base material strength</li> <li>• Base material condition (New, existing, cracked, uncracked, saturated, etc.)</li> <li>• Finishes, i.e. primed, galvanized, etc.</li> </ul>	 <p><i>LOD 350 Welded Headed Stud Bolt</i></p>

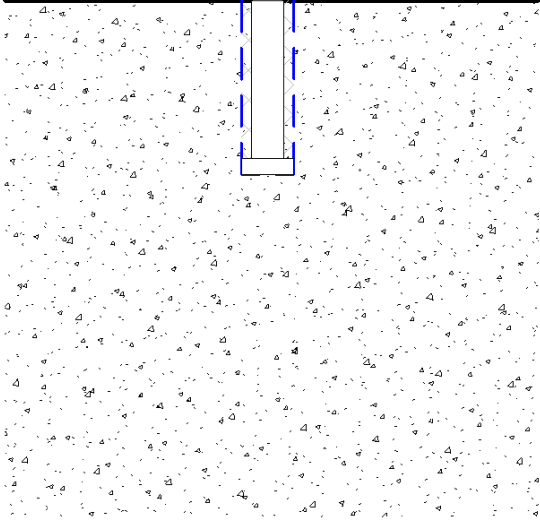

## Unifomat Omniclass

400	<p>Element modeling to include fabrication level information:</p> <ul style="list-style-type: none"> <li>• Anchor Threads</li> <li>• Anchor Washers</li> <li>• Anchor Nuts</li> </ul> <p>Other non-graphic information may be included such as:</p> <ul style="list-style-type: none"> <li>• Mark identification that correlates with bill of material (i.e., piece mark)</li> <li>• Member finish (primer, galvanized, etc.)</li> <li>• Fastener finish (i.e., black, zinc electroplated, hot-dipped galvanized)</li> </ul>	 <p><i>LOD 400 Welded Headed Stud Bolt</i></p>
-----	--	--

## N/A 23-13 23 11 Mechanical Fasteners – Adhesive Anchor

*Includes: Post-installed anchors per American Concrete Institute 318 building code.*

Associated Masterformat Sections: N/A

200	Refer to the model element of the main assembly being connected.	N/A
300	Refer to the model element of the main assembly being connected.	N/A

# Unifomat Omniclass

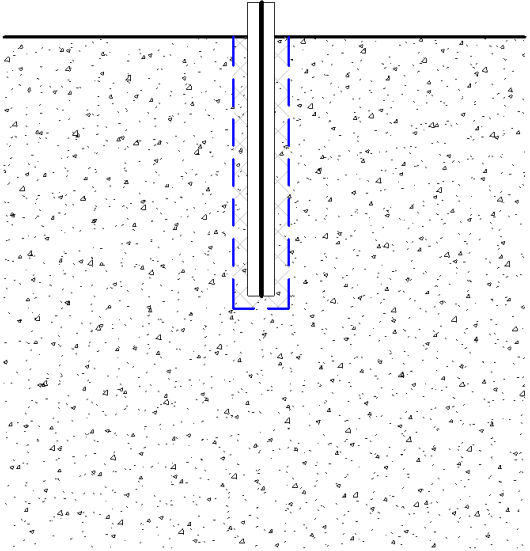
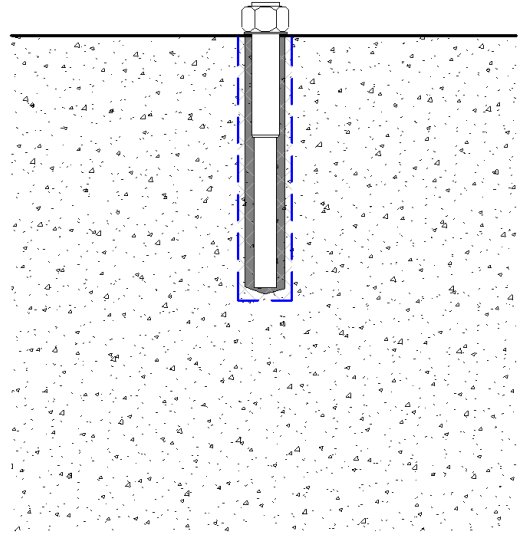
<p>350</p>	<p>Element modeling to include:</p> <ul style="list-style-type: none"> <li>• Anchor Length</li> <li>• Embedment Length</li> <li>• Projection Length</li> <li>• Edge Distance Zone</li> <li>• Spacing Zone</li> <li>• Geometry, base size without threads</li> </ul> <p>Required non-graphic information associated with model elements to include:</p> <ul style="list-style-type: none"> <li>• Anchor materials defined</li> <li>• Anchor type defined</li> <li>• Base material type (steel, concrete, masonry, etc)</li> <li>• Base material strength</li> <li>• Base material condition (New, existing, cracked, uncracked, saturated, etc.)</li> <li>• Finishes, i.e. primed, galvanized, etc.</li> <li>• Hole preparation specification</li> </ul>	 <p><i>LOD 350 Adhesive Anchor</i></p>
<p>400</p>	<p>Element modeling to include fabrication level information:</p> <ul style="list-style-type: none"> <li>• Anchor Threads</li> <li>• Anchor Washers</li> <li>• Anchor Nuts</li> </ul> <p>Other non-graphic information may be included such as:</p> <ul style="list-style-type: none"> <li>• Mark identification that correlates with bill of material (i.e., piece mark)</li> <li>• Member finish (primer, galvanized, etc.)</li> <li>• Fastener finish (i.e., black, zinc electroplated, hot-dipped galvanized)</li> </ul>	 <p><i>LOD 400 Adhesive Anchor</i></p>

# Unifomat Omniclass

## N/A 23-13 23 11 Mechanical Fasteners – Undercut Anchor

Includes: Post-installed anchors per American Concrete Institute 318 building code.

Associated Masterformat Sections: N/A

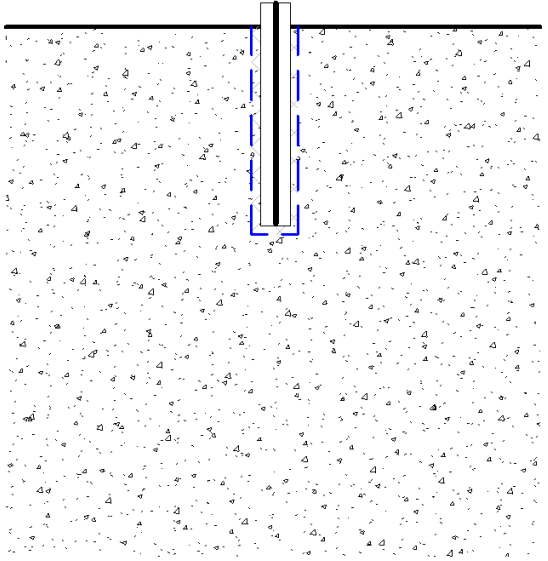
200	Refer to the model element of the main assembly being connected.	N/A
300	Refer to the model element of the main assembly being connected.	N/A
350	<p>Element modeling to include:</p> <ul style="list-style-type: none"> <li>• Anchor Length</li> <li>• Embedment Length</li> <li>• Projection Length</li> <li>• Edge Distance Zone</li> <li>• Spacing Zone</li> <li>• Geometry, base size without threads</li> </ul> <p>Required non-graphic information associated with model elements to include:</p> <ul style="list-style-type: none"> <li>• Anchor materials defined</li> <li>• Anchor type defined</li> <li>• Base material type (steel, concrete, masonry, etc)</li> <li>• Base material strength</li> <li>• Base material condition (New, existing, cracked, uncracked, saturated, etc.)</li> <li>• Finishes, i.e. primed, galvanized, etc.</li> <li>• Hole preparation specification</li> </ul>	 <p><i>LOD 350 Undercut Anchor</i></p>

# Unifomat Omniclass

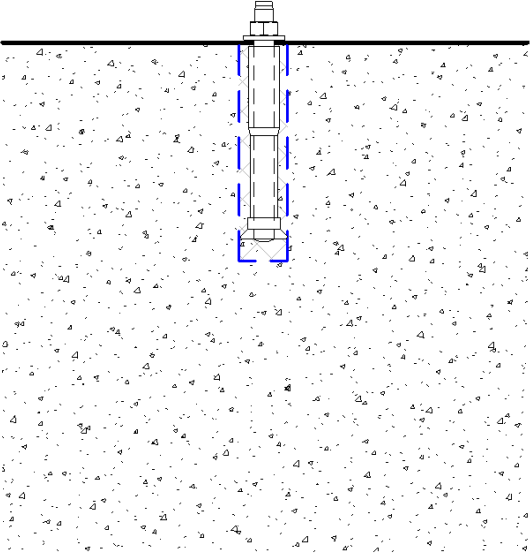
400	<p>Element modeling to include fabrication level information:</p> <ul style="list-style-type: none"><li>• Anchor Threads</li><li>• Anchor Washers</li><li>• Anchor Nuts</li></ul> <p>Other non-graphic information may be included such as:</p> <ul style="list-style-type: none"><li>• Mark identification that correlates with bill of material (i.e., piece mark)</li><li>• Member finish (primer, galvanized, etc.)</li><li>• Fastener finish (i.e., black, zinc electroplated, hot-dipped galvanized)</li></ul>	 <p><i>LOD 400 Undercut Anchor</i></p>
-----	--	--

Uniformat Omniclass

N/A 23-13 23 11 Mechanical Fasteners – Torque-controlled Expansion Anchor (Sleeve Type)

Includes: Post-installed anchors per American Concrete Institute 318 building code.

Associated Masterformat Sections: N/A

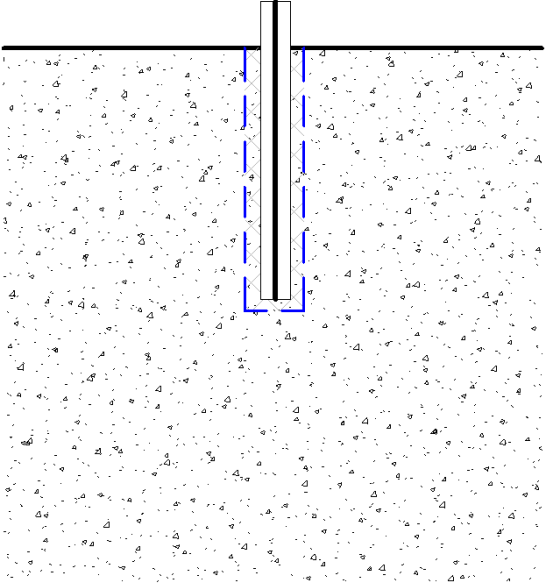
200	Refer to the model element of the main assembly being connected.	N/A
300	Refer to the model element of the main assembly being connected.	N/A
350	<p>Element modeling to include:</p> <ul style="list-style-type: none"> <li>• Anchor Length</li> <li>• Embedment Length</li> <li>• Projection Length</li> <li>• Edge Distance Zone</li> <li>• Spacing Zone</li> <li>• Geometry, base size without threads</li> </ul> <p>Required non-graphic information associated with model elements to include:</p> <ul style="list-style-type: none"> <li>• Anchor materials defined</li> <li>• Anchor type defined</li> <li>• Base material type (steel, concrete, masonry, etc)</li> <li>• Base material strength</li> <li>• Base material condition (New, existing, cracked, uncracked, saturated, etc.)</li> <li>• Finishes, i.e. primed, galvanized, etc.</li> <li>• Hole preparation specification</li> </ul>	 <p><i>LOD 350 Torque-Controlled Expansion Anchor (Sleeve Type)</i></p>

# Unifomat Omniclass

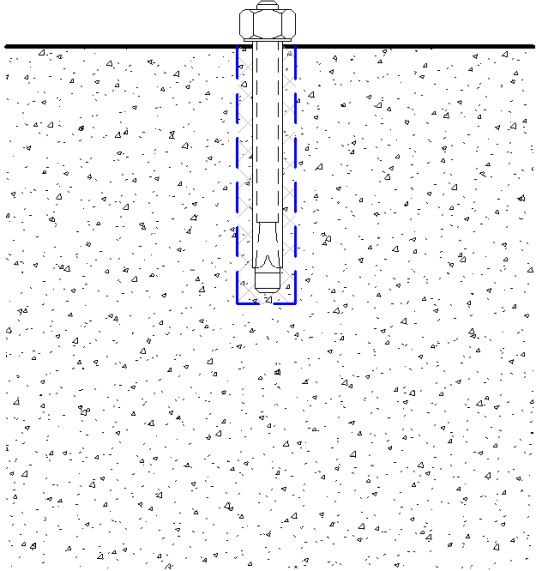
400	<p>Element modeling to include fabrication level information:</p> <ul style="list-style-type: none"><li>• Anchor Threads</li><li>• Anchor Washers</li><li>• Anchor Nuts</li></ul> <p>Other non-graphic information may be included such as:</p> <ul style="list-style-type: none"><li>• Mark identification that correlates with bill of material (i.e., piece mark)</li><li>• Member finish (primer, galvanized, etc.)</li><li>• Fastener finish (i.e., black, zinc electroplated, hot-dipped galvanized)</li></ul>	 <p><i>LOD 400 Torque-Controlled Expansion Anchor (Sleeve Type)</i></p>
-----	--	---

Uniformat Omniclass

N/A 23-13 23 11 Mechanical Fasteners – Torque-controlled Expansion Anchor (Stud Type)

Includes: Post-installed anchors per American Concrete Institute 318 building code.

Associated Masterformat Sections: N/A

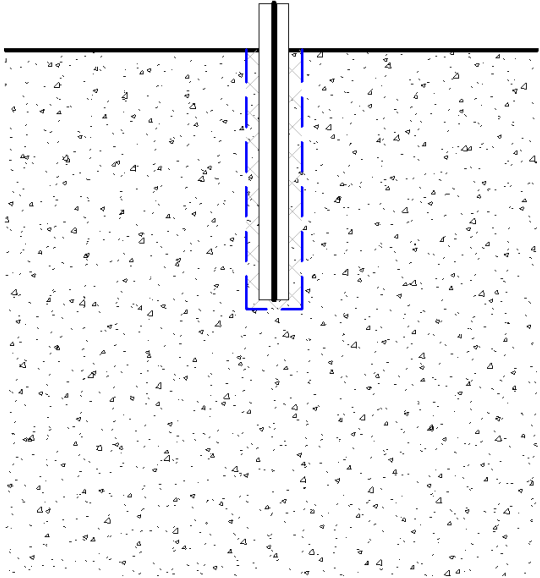
200	Refer to the model element of the main assembly being connected.	N/A
300	Refer to the model element of the main assembly being connected.	N/A
350	<p>Element modeling to include:</p> <ul style="list-style-type: none"> <li>• Anchor Length</li> <li>• Embedment Length</li> <li>• Projection Length</li> <li>• Edge Distance Zone</li> <li>• Spacing Zone</li> <li>• Geometry, base size without threads</li> </ul> <p>Required non-graphic information associated with model elements to include:</p> <ul style="list-style-type: none"> <li>• Anchor materials defined</li> <li>• Anchor type defined</li> <li>• Base material type (steel, concrete, masonry, etc)</li> <li>• Base material strength</li> <li>• Base material condition (New, existing, cracked, uncracked, saturated, etc.)</li> <li>• Finishes, i.e. primed, galvanized, etc.</li> <li>• Hole preparation specification</li> </ul>	 <p><i>LOD 350 Torque-Controlled Expansion Anchor (Stud Type)</i></p>

# Unifomat Omniclass

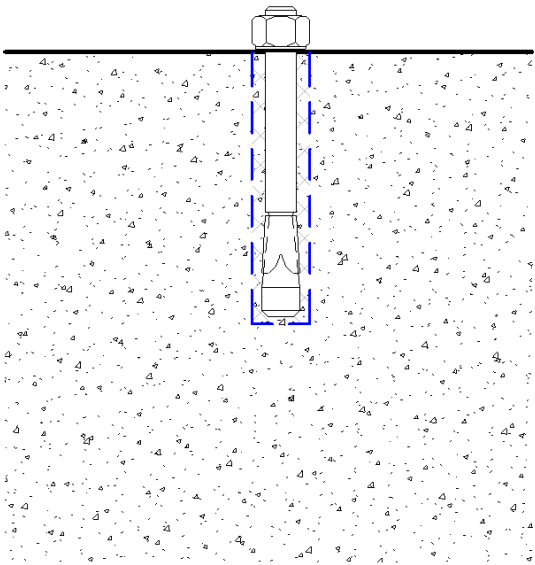
<p>400</p>	<p>Element modeling to include fabrication level information:</p> <ul style="list-style-type: none"><li>• Anchor Threads</li><li>• Anchor Washers</li><li>• Anchor Nuts</li></ul> <p>Other non-graphic information may be included such as:</p> <ul style="list-style-type: none"><li>• Mark identification that correlates with bill of material (i.e., piece mark)</li><li>• Member finish (primer, galvanized, etc.)</li><li>• Fastener finish (i.e., black, zinc electroplated, hot-dipped galvanized)</li></ul>	 <p><i>LOD 400 Torque-Controlled Expansion Anchor (Stud Type)</i></p>
------------	--	---



Uniformat Omniclass

N/A 23-13 23 11 Mechanical Fasteners – Drop-in Type  
Displacement-Controlled Expansion Anchor

Includes: Post-installed anchors per American Concrete Institute 318 building code.

Associated Masterformat Sections: N/A

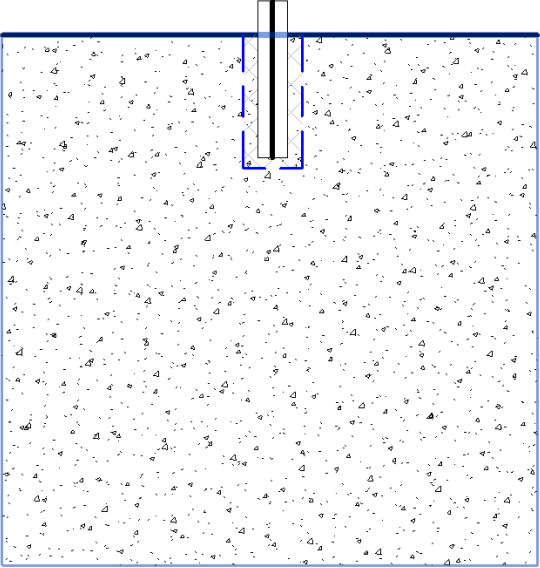
200	Refer to the model element of the main assembly being connected.	N/A
300	Refer to the model element of the main assembly being connected.	N/A
350	<p>Element modeling to include:</p> <ul style="list-style-type: none"> <li>• Anchor Length</li> <li>• Embedment Length</li> <li>• Projection Length</li> <li>• Edge Distance Zone</li> <li>• Spacing Zone</li> <li>• Geometry, base size without threads</li> </ul> <p>Required non-graphic information associated with model elements to include:</p> <ul style="list-style-type: none"> <li>• Anchor materials defined</li> <li>• Anchor type defined</li> <li>• Base material type (steel, concrete, masonry, etc)</li> <li>• Base material strength</li> <li>• Base material condition (New, existing, cracked, uncracked, saturated, etc.)</li> <li>• Finishes, i.e. primed, galvanized, etc.</li> <li>• Hole preparation specification</li> </ul>	 <p><i>LOD 350 Drop-In Type Displacement-Controlled Expansion Anchor</i></p>

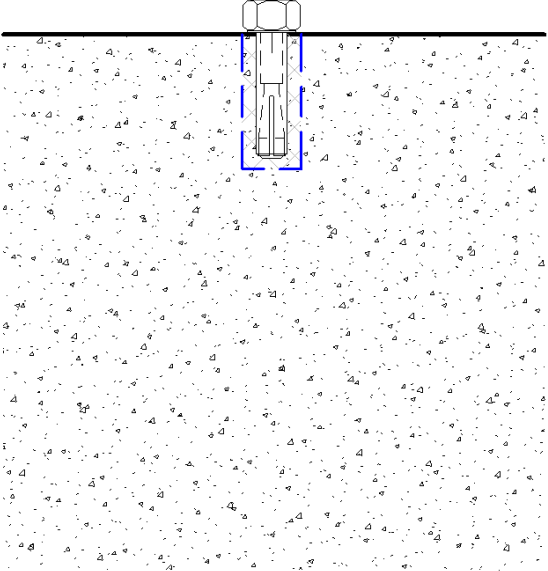

# Unifomat Omniclass

400	<p>Element modeling to include fabrication level information:</p> <ul style="list-style-type: none"><li>• Anchor Threads</li><li>• Anchor Washers</li><li>• Anchor Nuts</li></ul> <p>Other non-graphic information may be included such as:</p> <ul style="list-style-type: none"><li>• Mark identification that correlates with bill of material (i.e., piece mark)</li><li>• Member finish (primer, galvanized, etc.)</li><li>• Fastener finish (i.e., black, zinc electroplated, hot-dipped galvanized)</li></ul>	 <p><i>LOD 400 Drop-In Type Displacement-Controlled Expansion Anchor</i></p>
-----	--	--

Uniformat Omniclass

N/A 23-13 31 Structural Concrete Products  
N/A 23-13 31 17 Formwork– Concrete Column

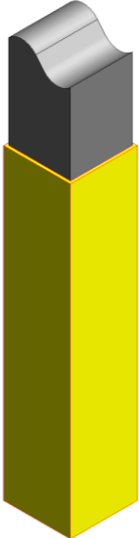
Associated Masterformat Sections: 03-10-00

<p>200</p>	<p>Element modeling to include:</p> <ul style="list-style-type: none"> <li>• Approximate geometry (e.g. panel dimensions or depth).</li> </ul>	 <p><i>LOD 200 Concrete Column Formwork</i></p>
<p>300</p>	<p>Element modeling to include:</p> <ul style="list-style-type: none"> <li>• Formwork materials are defined. These may include, but are not limited to plastic, wood or steel.</li> <li>• Material properties are defined. These may include, but are not limited to material finish, type, size, grade, strength, etc.</li> <li>• Products manufacturer is defined.</li> </ul>	 <p><i>LOD 300 Concrete Column Formwork</i></p>

## Unifomat Omniclass

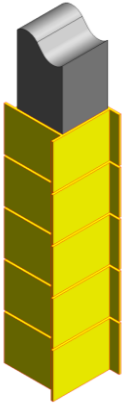
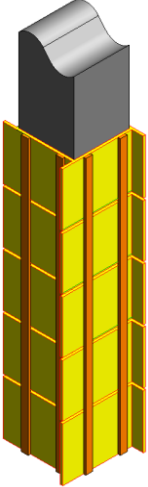
<p>350</p>	<p>Element modeling to include:</p> <ul style="list-style-type: none"> <li>• Insulating faces are defined.</li> <li>• Insulating details are defined. These include, but are not limited, too, the type of insulation specified, the temperature change the insulation will cause and the thickness of the insulation within the formwork.</li> <li>• Hardware and fastener specification defined (may include Nails, Wood Screws, Bolts, Lag Screws, Ties, Anchors, Hangers, etc.)</li> <li>• Shoring connections are defined.</li> <li>• Scaffolding connections are defined</li> <li>• Liner details are defined.</li> </ul>	 <p><i>LOD 350 Concrete Column Formwork</i></p>
<p>400</p>	<p>Element modeling to include:</p> <ul style="list-style-type: none"> <li>• All connections, fasteners, and forms detailed and modeled.</li> <li>• Nails, Screws, Anchors, etc.</li> </ul>	 <p><i>LOD 400 Concrete Column Formwork</i></p>

# Unifomat Omniclass

## N/A 23-13 31 17 Formwork– Concrete Slab

Associated Masterformat Sections: 03-10-00

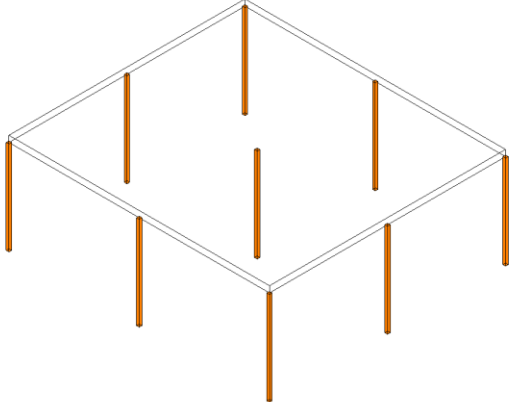
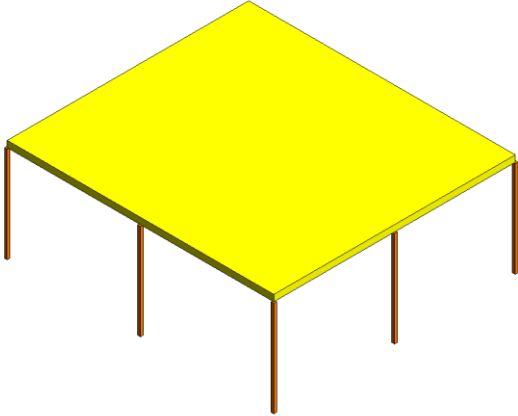
<p>200</p>	<p>Element modeling to include:</p> <ul style="list-style-type: none"> <li>Approximate geometry (e.g. formwork dimensions or depth).</li> </ul>	 <p><i>LOD 200 Concrete Slab Formwork</i></p>
<p>300</p>	<p>Element modeling to include:</p> <ul style="list-style-type: none"> <li>Formwork materials are defined. These may include, but are not limited to plastic, wood or steel.</li> <li>Material properties are defined. These may include, but are not limited to material finish, type, size, grade, strength, etc.</li> <li>Products manufacturer is defined.</li> </ul>	 <p><i>LOD 300 Concrete Slab Formwork</i></p>

# Unifomat Omniclass

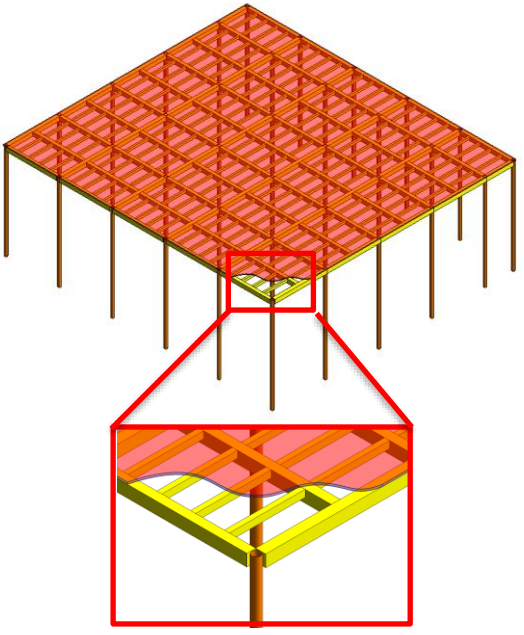
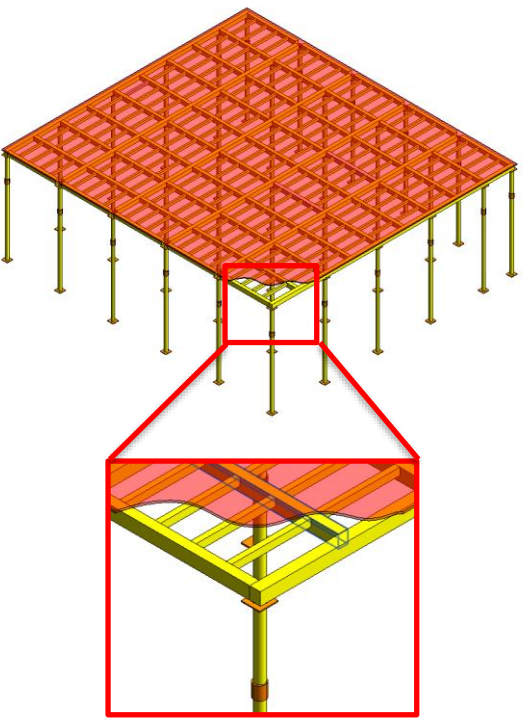
<p>350</p>	<p>Element modeling to include:</p> <ul style="list-style-type: none"><li>• Insulating faces are defined.</li><li>• Insulating details are defined. These include, but are not limited to, the type of insulation specified, the temperature change the insulation will cause and the thickness of the insulation within the formwork.</li><li>• Hardware and fastener specification defined (may include Nails, Wood Screws, Bolts, Lag Screws, Ties, Anchors, Hangers, etc.)</li><li>• Shoring connections are defined.</li><li>• Scaffolding connections are defined</li><li>• Liner details are defined.</li></ul>	 <p><i>LOD 350 Concrete Slab Formwork</i></p>
<p>400</p>	<p>Element modeling to include:</p> <ul style="list-style-type: none"><li>• All supports and formwork detailed and modeled.</li><li>• Wood supports, metal supports, plates, etc.</li></ul>	 <p><i>LOD 400 Concrete Slab Formwork</i></p>

# Unifomat Omniclass

## CIVIL

### Highway Bridges Precast Structural I Girder (Concrete)

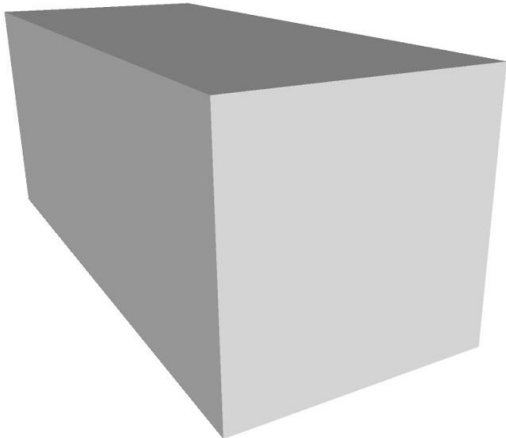
100		
200	<p>Element modeling to include:</p> <ul style="list-style-type: none"><li>• Type of structural concrete system</li><li>• Approximate geometry (e.g. depth) of structural elements</li></ul>	 <p><i>LOD 200 Highway Bridges Precast Structural I Girder (Concrete)</i></p>

## Unifomat Omniclass

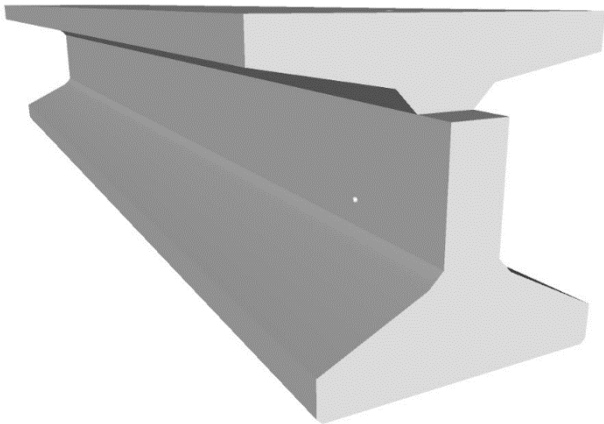
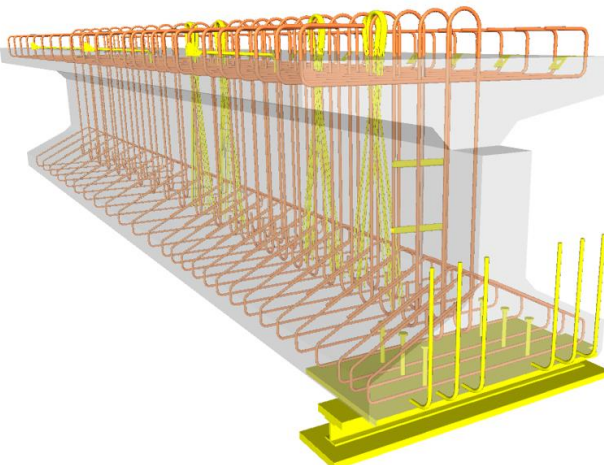
<p>300</p>	<p>Element modeling to include:</p> <ul style="list-style-type: none"> <li>• Specific sizes and locations of main concrete structural members modeled per defined structural grid with correct orientation</li> <li>• Concrete defined per spec (strength, air entrainment, aggregate size, etc.)</li> <li>• All sloping surfaces included in model element with exception of elements affected by manufacturer selection</li> </ul>	 <p><i>LOD 300 Highway Bridges Precast Structural I Girder (Concrete)</i></p>
<p>350</p>	<p>Element modeling to include:</p> <ul style="list-style-type: none"> <li>• Reinforcing Post-tension profiles and strand locations</li> <li>• Reinforcement called out, modeled if required by the BXP, typically only in congested areas</li> <li>• Chamfer</li> <li>• Pour joints and sequences to help identify reinforcing lap splice locations, scheduling, etc.</li> <li>• Expansion Joints</li> <li>• Lifting devices</li> <li>• Embeds and anchor rods</li> <li>• Post-tension profile and strands modeled if required by the BXP</li> <li>• Penetrations for items such as MEP</li> <li>• Any permanent forming or shoring components</li> </ul>	 <p><i>LOD 350 Highway Bridges Precast Structural I Girder (Concrete)</i></p>

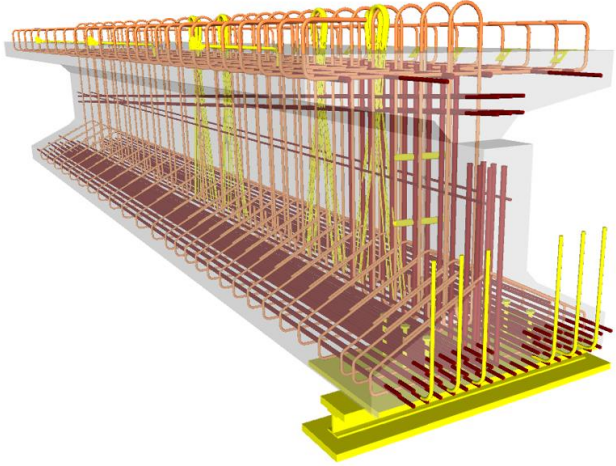

# Unifomat Omniclass

400	<p>Element modeling to include:</p> <ul style="list-style-type: none"><li>All reinforcement including post tension elements detailed and modeled</li></ul>	 <p><i>LOD 400 Highway Bridges Precast Structural I Girder (Concrete)</i></p>
-----	--	---

# Unifomat Omniclass

## Highway Bridge Girder Steel

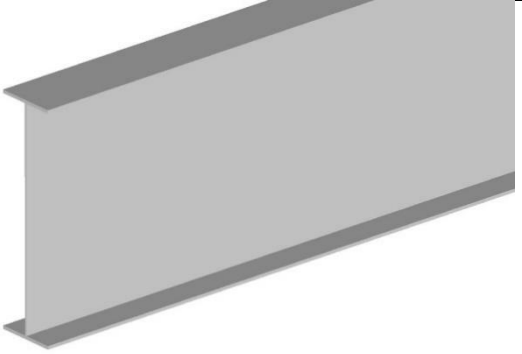
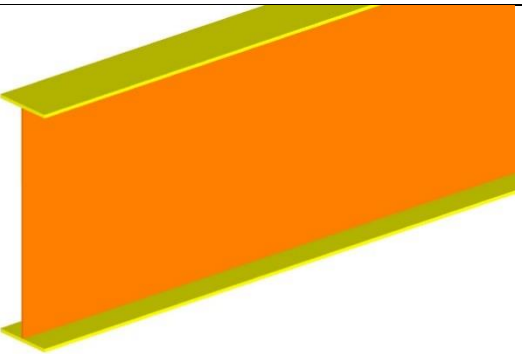
200	Generic mass of Girder	 <p><i>LOD 200 Highway Bridge Girder Steel</i></p>
300	Element modeling to include <ul style="list-style-type: none"><li>3) Girder Depth</li><li>4) Web Plate Length<ul style="list-style-type: none"><li>• Flange Plate Width</li></ul></li></ul>	 <p><i>LOD 300 Highway Bridge Girder Steel</i></p>

## Unifomat Omniclass

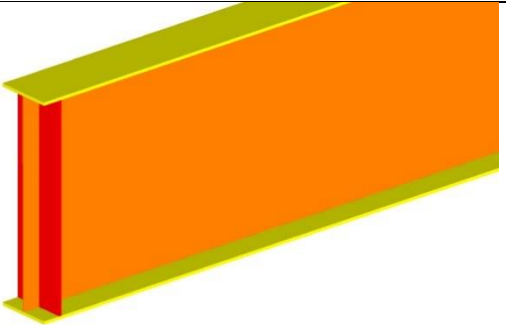
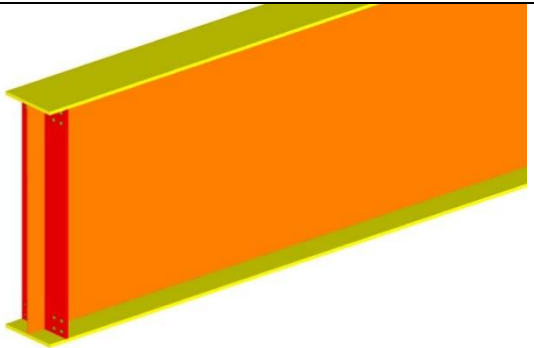
350	<p>Element modeling to include:</p> <ul style="list-style-type: none"> <li>• Stiffeners</li> <li>• Exact sloping of members</li> <li>• Splits between Plate Girders</li> </ul>	 <p><i>LOD 350 Highway Bridge Girder Steel</i></p>
400	<p>Element modeling to include fabrication level information:</p> <ul style="list-style-type: none"> <li>• Welds</li> <li>• Coping of members</li> <li>• Washers, nuts, etc.</li> <li>• Grating, holes in grating</li> <li>• All assembly elements</li> </ul>	 <p><i>LOD 400 Highway Bridge Girder Steel</i></p>

## Railroad Bridges Precast Structural I Girder (Concrete)

100		
-----	--	--

## Unifomat Omniclass

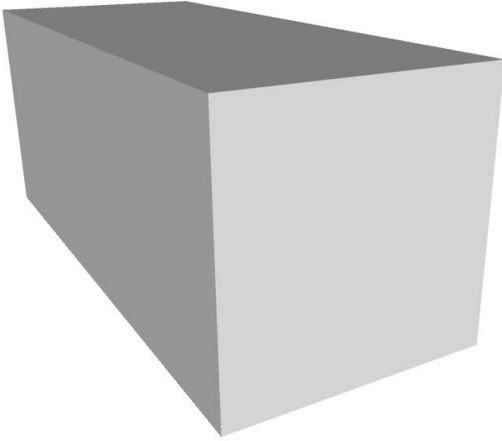
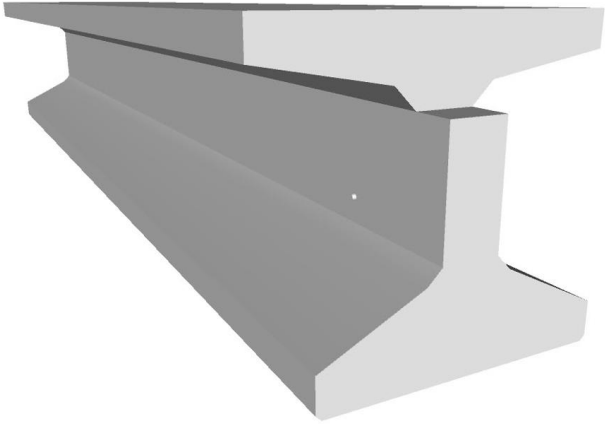
<p>200</p>	<p>Element modeling to include:</p> <ul style="list-style-type: none"> <li>• Type of structural concrete system</li> <li>• Approximate geometry (e.g. depth) of structural elements</li> </ul>	 <p><i>LOD 200 Railroad Bridges Precast Structural I Girder (Concrete)</i></p>
<p>300</p>	<p>Element modeling to include:</p> <ul style="list-style-type: none"> <li>• Specific sizes and locations of main concrete structural members modeled per defined structural grid with correct orientation</li> <li>• Concrete defined per spec (strength, air entrainment, aggregate size, etc.)</li> <li>• All sloping surfaces included in model element with exception of elements affected by manufacturer selection</li> </ul>	 <p><i>LOD 300 Railroad Bridges Precast Structural I Girder (Concrete)</i></p>

## Unifomat Omniclass

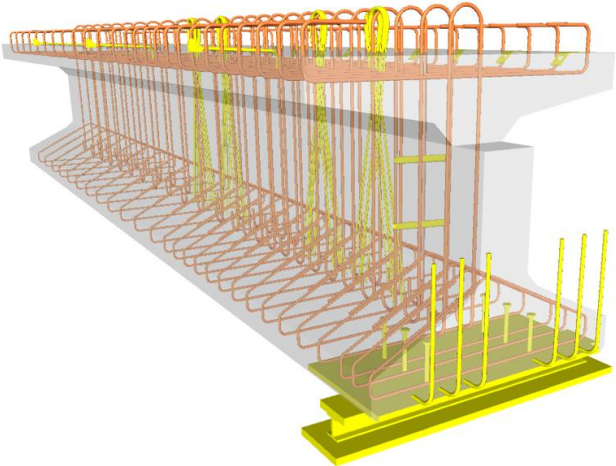
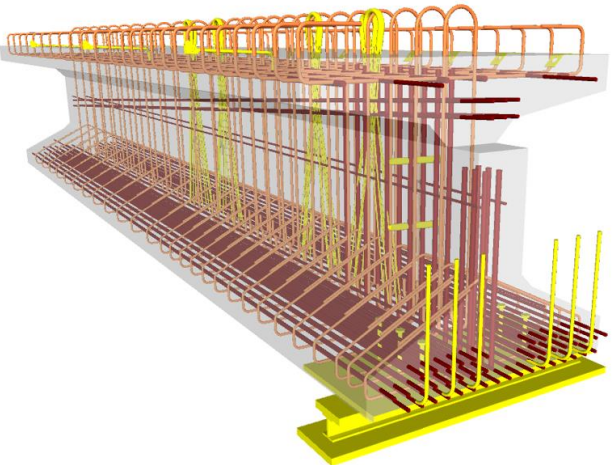
<p>350</p>	<p>Element modeling to include:</p> <ul style="list-style-type: none"> <li>• Reinforcing Post-tension profiles and strand locations</li> <li>• Reinforcement called out, modeled if required by the BXP, typically only in congested areas</li> <li>• Pour joints and sequences to help identify reinforcing lap splice locations, scheduling, etc.</li> <li>• Chamfer</li> <li>• Expansion Joints</li> <li>• Lifting devices</li> <li>• Embeds and anchor rods</li> <li>• Post-tension profile and strands modeled if required by the BXP</li> <li>• Penetrations for items such as MEP</li> <li>• Any permanent forming or shoring components</li> </ul>	 <p><i>LOD 350 Railroad Bridges Precast Structural I Girder (Concrete)</i></p>
<p>400</p>	<p>Element modeling to include:</p> <ul style="list-style-type: none"> <li>• All reinforcement including post tension elements detailed and modeled</li> <li>• Finishes</li> </ul>	 <p><i>LOD 400 Railroad Bridges Precast Structural I Girder (Concrete)</i></p>

## Railroad Bridge Girder Steel

# Unifomat Omniclass

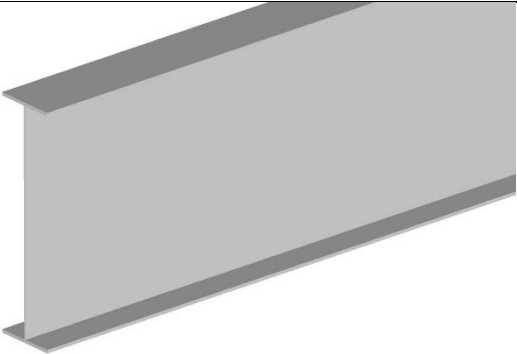
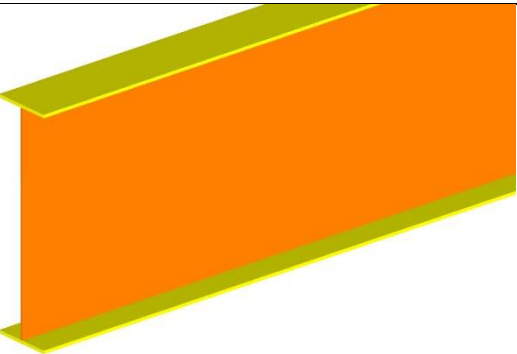
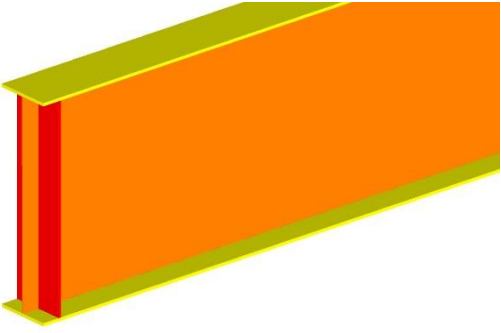
200	Generic mass of Girder	 <p><i>LOD 200 Railroad Bridge Girder Steel</i></p>
300	<p>Element modeling to include:</p> <ul style="list-style-type: none"> <li>• Girder Depth</li> <li>• Web Plate Length</li> <li>• Flange Plate Width</li> </ul>	 <p><i>LOD 300 Railroad Bridge Girder Steel</i></p>
350	<p>Element modeling to include:</p> <ul style="list-style-type: none"> <li>• Stiffeners</li> <li>• Exact sloping of members</li> <li>• Splits between Plate Girders</li> </ul>	 <p><i>LOD 350 Railroad Bridge Girder Steel</i></p>

## Unifomat Omniclass

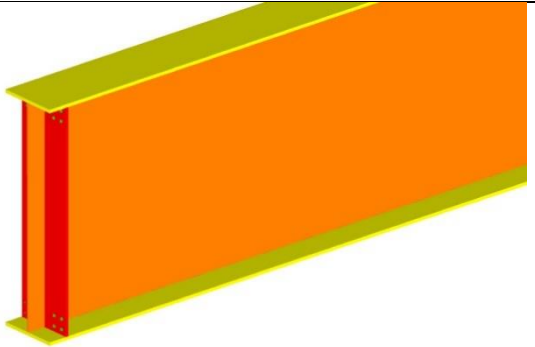
400	<p>Element modeling to include fabrication level information:</p> <ul style="list-style-type: none"><li>• Welds</li><li>• Coping of members</li><li>• Washers, nuts, etc.</li><li>• Grating, holes in grating</li><li>• All assembly elements</li></ul>	 <p><i>LOD 400 Railroad Bridge Girder Steel</i></p>
-----	---	---