

2015

LEVEL OF DEVELOPMENT SPECIFICATION

October 30, 2015

BIMFORUM

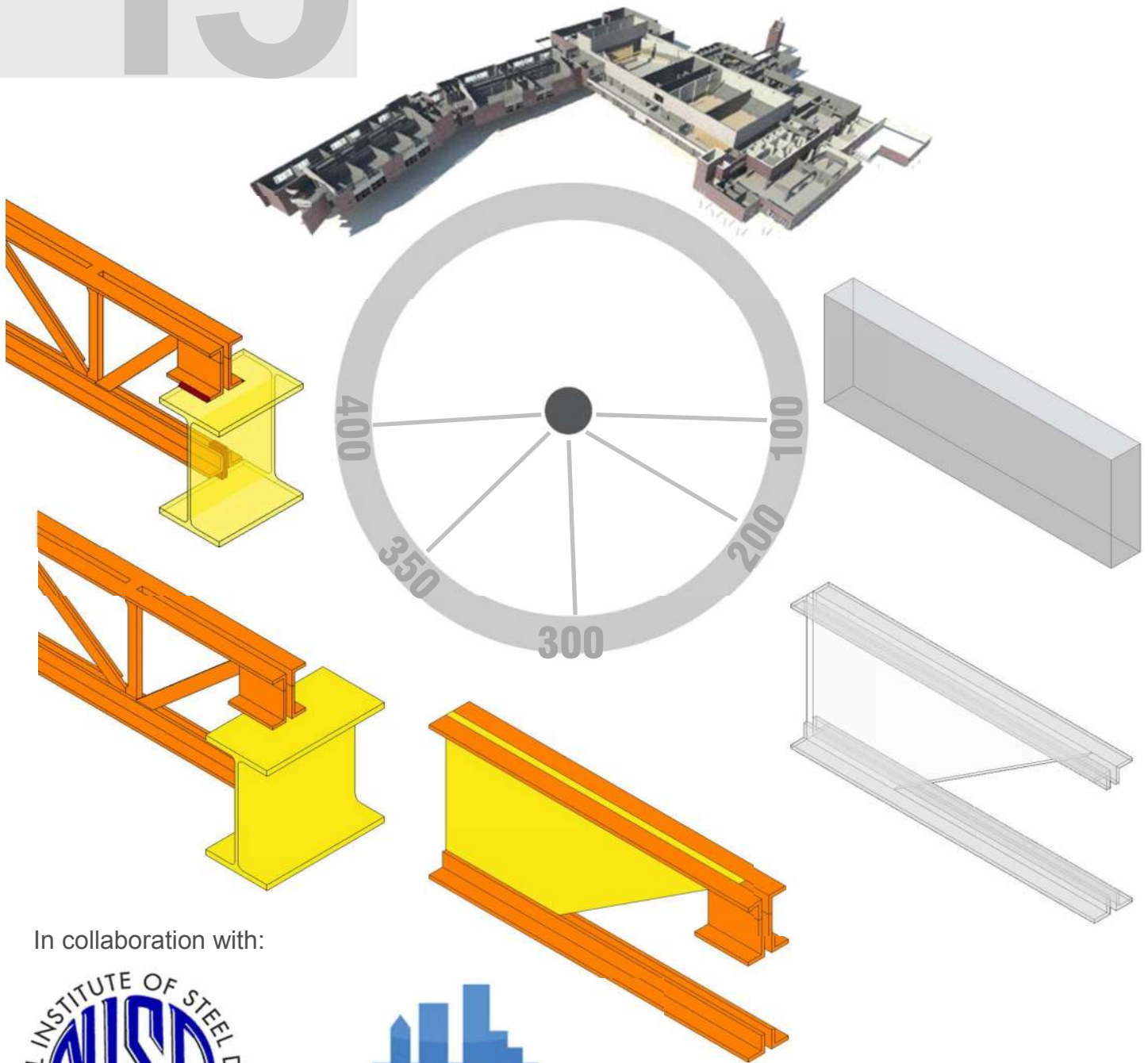

In collaboration with:

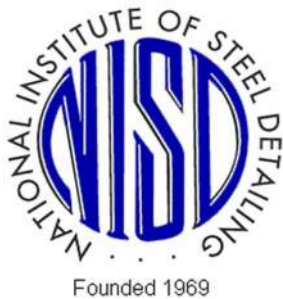

Level of Development Specification

Version: 2015

October 30, 2015

For Building Information Models

Nothing contained in this work shall be considered to be the rendering of legal advice for specific cases, and readers are responsible for obtaining such advice from their own legal counsel. This work and any forms herein are intended solely for educational and informational purposes.

Level of Development Specification © 2015 by BIMForum. No portions of this work may be reproduced or displayed without the express written permission of the copyright holders. All rights reserved.

CONTENTS

CONTENTS.....	2
ACKNOWLEDGEMENTS.....	8
INTRODUCTION.....	10
1 Overview	10
1.1 Description.....	10
1.1.1 LODs and Design Phase	10
1.1.2 LODs and Model Definition.....	10
1.2 Intent.....	11
1.2.1 Not a set of Requirements.....	11
1.2.2 Complements a BIM Execution Plan (BIMXP).....	11
1.3 Background.....	11
1.3.1 AIA Effort	11
1.3.2 BIMForum Effort	11
1.3.3 LOD Definitions	11
2 Levels of Development.....	12
2.1 BIM as a Communication Tool.....	12
2.2 Level of Development vs. Level of Detail	12
2.3 Fundamental LOD Definitions	12
2.3.1 LOD 100	12
2.3.2 LOD 200	12
2.3.3 LOD 300	13
2.3.4 LOD 350	13
2.3.5 LOD 400	13
2.3.6 LOD 500	13
2.4 Example – Light Fixture:	13
3 Using the Specification.....	13
3.1 Glossary.....	13
3.1.1 Specific:.....	13
3.1.2 Actual:.....	13
3.2 Details.....	13
3.2.1 Order of Precedence	13
3.2.2 LOD Definitions as Minimum Requirements.....	14
3.2.3 LOD Definitions are Cumulative	14
3.2.4 Model Element Author	14
3.2.5 2D Supplementary Drawings.....	14
3.3 Project-Specific Information	14
3.3.1 Size Thresholds.....	14
3.3.2 Clearances	14
3.4 Using the Specification with a BIMXP	14
3.4.1 Reliance.....	14
3.4.2 Multiple uses.....	14
3.4.3 Efficient sequencing	15

3.4.4	Avoidance of over-modeling	15
4	Organization of the Specification	15
4.1	Geometric and Attribute Information	15
4.1.1	Part A: Element Geometry.....	15
4.1.2	Part B: Associated Attribute Information	15
4.2	Model Element Table	15
4.2.1	Building Systems	15
4.2.2	Milestones/Deliverables	16
4.3	Attribute Tables	16
4.3.1	Attribute Table Anatomy	16
4.3.2	MEP Attribute Tables.....	17
4.3.3	Using the Attribute Tables	17
5	Updates of This Document	17
5.1	Revision History	17
5.2	Revision Process	18
5.2.1	Public Comment	18
5.2.2	Appendix.....	18
A:	SUBSTRUCTURE.....	18
A10	Foundations	18
A1010	– Standard Foundations.....	18
A1010.10	– Wall Foundations (Shallow Foundations).....	19
A1010.30	– Column Foundations (Deep Foundations).....	21
A1020	– Special Foundations.....	22
A1020.80	– Grade Beams	24
A20	Subgrade Enclosures.....	25
A2010	– Walls for Subgrade Enclosures	26
A40	Slabs-on-Grade.....	27
A4010	– Standard Slabs-on-Grade	27
A4020	– Structural Slabs-on-Grade.....	29
B:	SHELL.....	30
B10	Superstructure.....	30
B1010	– Floor Construction.....	30
B1020	– Roof Construction	48
B1080	– Stairs	50
B20	Exterior Vertical Enclosures	54
B2010	– Exterior Walls	54
B2020	– Exterior Windows	65
B2050	– Exterior Doors and Grilles	68
B2070	- Exterior Louvers and Vents.....	71
B2080	- Exterior Wall Appurtenances.....	71
B2090	– Exterior Wall Specialties	72

B30 Exterior Horizontal Enclosures	72
B3010 – Roofing.....	72
B3020 – Roof Appurtenances	73
B3040 – Traffic Bearing Horizontal Enclosures	73
B3060 – Horizontal Openings.....	74
B3080 – Overhead Exterior Enclosures	75
C: INTERIORS	76
C10 Interior Construction.....	76
C1010 – Interior Partitions	76
C1020 – Interior Windows	86
C1030 – Interior Doors	87
C1040 – Interior Grilles and Gates	89
C1060 – Raised Floor Construction.....	89
C1070 – Suspended Ceiling Construction.....	90
C1090 – Interior Specialties	90
C20 Interior Finishes	94
C2010 – Wall Finishes.....	94
C2020 – Interior Fabrications	95
C2030 – Flooring.....	95
C2040 – Stair Finishes	95
C2050 – Ceiling Finishes.....	95
D: SERVICES.....	96
D10 Conveying.....	96
D1010 – Vertical Conveying Systems	96
D1030 – Horizontal Conveying.....	96
D1050 – Material Handling	97
D1080 – Operable Access Systems	100
D20 Plumbing.....	101
D2010 – Domestic Water Distribution.....	101
D2020 – Sanitary Drainage	106
D2020.10 – Sanitary Sewerage Equipment.....	107
D2030 – Building Support Plumbing Systems	109
D2050 – General Service Compressed-Air	114
D2060 – Process Support Plumbing Systems.....	114
D30 HVAC.....	117
D3010 – Facility Fuel Systems	117
D3020 – Heating Systems.....	122
D3030 – Cooling Systems	125
D3050 – Facility HVAC Distribution Systems	128
D3060 – Ventilation	131
D3070 – Special Purpose HVAC Systems	135
D40 Fire Protection.....	135
D4010 – Fire Suppression.....	135

D4030 – Fire Protection Specialties	138
D50 Electrical	139
D5010 – Facility Power Generation	139
D5020 – Electrical Service and Distribution	141
D5030 – General Purpose Electrical Power	144
D5040 – Lighting	145
D5080 – Miscellaneous Electrical Systems	147
D60 Communications	149
D6010 – Data Communications	149
D6020 – Voice Communications	149
D6030 – Audio-Video Communication	149
D6060 – Distributed Communications and Monitoring	149
D6090 – Communications Supplementary Components	149
D70 Electronic Safety and Security	149
D7010 – Access Control and Intrusion Detection	149
D7030 – Electronic Surveillance	149
D7050 – Detection and Alarm	149
D7070 – Electronic Monitoring and Control	150
D7090 – Electronic Safety and Security Supplementary Components	150
D80 Integrated Automation	150
D8010 – Integrated Automation Facility Controls	150
E: EQUIPMENT & FURNISHINGS	151
E10 Equipment	151
E1010 – Vehicle and Pedestrian Equipment	151
E1030 – Commercial Equipment	151
E1040 – Institutional Equipment	153
E1060 – Residential Equipment	153
E1070 – Entertainment and Recreational Equipment	153
E1090 – Other Equipment	153
E20 Furnishings	154
E2010 – Fixed Furnishings	154
E2050 – Movable Furnishings	154
F: SPECIAL CONSTRUCTION & DEMOLITION	156
F10 Special Construction	156
F1010 – Integrated Construction	156
F1020 – Special Structures	156
F1030 – Special Function Construction	156
F1050 – Special Facility Components	156
F1060 – Athletic and Recreational Special Construction	156
F1080 – Special Instrumentation	156
F20 Facility Remediation	156

F2010 – Hazardous Materials Remediation	156
F30 Demolition	156
F3010 – Structure Demolition	156
F3030 – Selective Demolition	156
F3050 – Structure Moving	156
G: BUILDING SITEWORK.....	157
G10 Site Preparation	157
G1010 – Site Clearing	157
G1020 – Site Elements Demolition.....	157
G1030 – Site Element Relocations.....	157
G1050 – Site Remediation	157
G1070 – Site Earthwork	157
G20 Site Improvements.....	158
G2010 – Roadways.....	158
G2020 – Parking Lots.....	158
G2030 – Pedestrian Plazas and Walkways.....	159
G2040 – Airfields.....	159
G2050 – Athletic, Recreational, and Playfield Areas	159
G2060 – Site Development	159
G2080 – Landscaping	159
G30 Liquid and Gas Site Utilities.....	160
G3010 – Water Utilities.....	160
G3020 – Sanitary Sewerage Utilities.....	160
G3030 – Storm Drainage Utilities	160
G3050 – Site Energy Distribution	160
G3060 – Site Fuel Distribution.....	160
G3090 – Liquid and Gas Site Utilities Supplementary Components.....	161
G40 Electrical Site Improvements	161
G4010 – Site Electric Distribution Systems	162
G4050 – Site Lighting.....	163
G50 Site Communications.....	164
G5010 – Site Communications Systems	164
G90 Miscellaneous Site Construction.....	164
G9010 – Tunnels.....	164
Graphics Index	165
Appendix	i
B1010.10 – Precast Structural Inverted T Beam (Concrete)	ii
B1010.10 – Precast Structural Column (Concrete)	iv
B1010.10 – Precast Structural Double Tee (Concrete)	vi
B1010.10 – Precast Wall (Concrete)	viii
B1010 – Highway Bridges Precast Structural I Girder (Concrete)	x
B1010 - Highway Bridge Girder Steel.....	xii
B1010 – Railroad Bridges Precast Structural I Girder (Concrete)	xiv

B1010 - Railroad Bridge Girder Steel	xvi
C2010.20 – Precast Structural Stairs (Concrete)	xviii
F1110 - Special Structures: Pre-engineered Metal Building Structures.....	xx
F1110 - Special Structures: Pre-engineered Metal Building – Rafter, Frames, and Columns	xx

ACKNOWLEDGEMENTS

Many thanks to all the individuals and organizations who reviewed and contributed to this work, and to the following industry association representatives and co-chairs of the major discipline subgroups who made this document possible:

Overall co-chairs

Jan Reinhardt, Adept Project Delivery

Jim Bedrick, FAIA, AEC Process Engineering

Current Committee Co-Chairs

	Design	Construction
Structures	Will Ikerd, PE, LEED AP Ikerd Consulting	David Merrifield Steel Fab, Inc.
Exterior Skin	James Vandezande AIA, HOK	Walt Cichonski L F Driscoll
Interior Construction	Ron Dellaria, RA, CSI Astorino/Cannon Design	Brian Filkins Mortenson
Building Services	Birgitta Foster VDCO Tech	David Francis Murray Company Aaron Lawson Morrow Meadows
Civil	Will Ikerd, PE, LEED AP Ikerd Consulting	Dan Russell, LEED AP, Sundt Construction, Inc.
Bridge: Highway & Rail	Will Ikerd, PE, LEED AP Ikerd Consulting	David Merrifield Steel Fab, Inc.

Industry association representatives

Dmitri Alferieff, Associated General Contractors

Michael Bomba, Esq., American Institute of Architects

Overall Editing and Graphics Creation

IKERD Consulting, LLC (IKERD.com)

Additional Contributors

In addition, we'd like to thank the many contributors from all sectors of the industry who helped make this specification possible, including:

Andy Jizba, US CAD

Bill Klorman, Klorman Construction & ACI 131 BIM Committee Member (Concrete)

Brenda Ikerd, Ikerd Consulting (Structures, Civil)

Brian Skripac, Astorino/Cannon Design, AIA TAP

Chuck Eastman, Ph.D, Georgia Institute of Technology

David Merrifield, Steel Fab, Inc.

Eloisa Amaya, Ikerd Consulting (Graphics Editing, Structures, and Cover)

Jamie L. Davis, PE, LEED AP, Ryan Biggs | Clark Davis Engineering & Surveying (Masonry)

Jason P. Lien, PE, Precast Concrete Institute (PCI) BIM Committee, EnCon United (Precast)

Joe Cipra, Vulcraft/Verco Group (Structural Steel Open Web Joists and Metal Deck)

John Russo, AIA, President, US Institute of Building Documentation (Laser Scanning & Level Of Accuracy)

Kirk Capristo, Astorino (Cover)

Lee Garduno, Southland Industries (MEP)

Luke Faulkner, LEED AP, AISC (Structural Steel)

Matthew J. Gomez PE, SE, Gerdau (Structural Steel)

Michael Bolduc, PE (MA), Simpson Gumpertz & Heger (Structural)

Michael Gustafason, PE, Autodesk (Structural)

Michael Mulder, Southland Industries (MEP)

Murat Karakas, Arup (MEP)

Paul J. Hause, PE, Structural Consultants Inc. (Structural)

Peter J. Carrato, Ph.D., PE, SE, Bechtel & ACI 131 BIM Committee Chair (Concrete)

R. Wayne Muir, P.E., Structural Consultants Inc. & SEI-CASE BIM Committee Co-Chair (Structures)

Rebecca Stanford, Ikerd Consulting (Structures)

Roger Becker, PE, SE, Precast Concrete Institute (PCI) Managing Director of Research and Development (Precast)

Schaeffer Harris, EIT, Ikerd Consulting (MEP)

Scott Babin, ITW Building Components Group (Wood)

Soheil Seiqali, Klorman Construction (Concrete)

Steven Bumbalough, ITW Building Components Group (Wood)

Trevor Koller, EIT, Ikerd Consulting (Structural, Bridge)

INTRODUCTION

1 Overview

1.1 Description

The *Level of Development (LOD) Specification* is a reference that enables practitioners in the AEC Industry to specify and articulate with a high degree of clarity the content and reliability of Building Information Models (BIMs) at various stages in the design and construction process.

The Specification is a detailed interpretation of the LOD schema developed by the American Institute of Architects (AIA) for its *E202-2009 BIM and Digital Data Exhibit* and updated for its *G202-2013 Project BIM Protocol Form*¹, defining and illustrating² characteristics of model elements of different building systems at different Levels of Development, organized according to CSI Uniformat 2010³. Its intent is to help explain the LOD framework and standardize its use so that it becomes more useful as a communication tool.

The LOD Specification adheres to the intent of the LOD schema as developed by the AIA, and as such it is important to emphasize several points here.

1.1.1 LODs and Design Phase

The LODs are not defined by design phases. Rather, design phase completion, as well as any other milestone or deliverable, can be defined through the LOD language. There are several important reasons for this approach:

- 1) There is currently no detailed standard for the design phases. Many architects have created in-house standards, but these differ from one firm to the next, and even within a single firm the requirements are sometimes adjusted to the needs of a particular project.
- 2) Building systems progress from concept to precise definition at different rates, so at any given time different elements will be at different points along this progression. At completion of the Schematic Design phase, for example, the model will include many elements at LOD 200, but will also include many at LOD 100, as well as some at LOD 300, and possibly even LOD 400.

1.1.2 LODs and Model Definition

There is no such thing as an “LOD ### model.” As previously stated, project models at any stage of delivery will invariably contain elements and assemblies at various levels of development. As an example, it is not logical to require an “LOD 200 model” at the completion of the schematic design phase. Instead, the “100% SD Model” will contain modeled elements at various levels of development.

¹ AIA Contract Document *G202-2013, Building Information Modeling Protocol Form* is part of a series of digital practice documents the AIA published in June 2013. This series consists of *AIA E203™–2013, Building Information Modeling and Digital Data Exhibit*, *AIA G201™–2013, Project Digital Data Protocol Form*, and *AIA G202™–2013, Project Building Information Modeling Protocol Form*. For general information on the documents and downloadable samples see www.aia.org/digitaldocs. For executable versions of the documents see <http://www.aia.org/contractdocs>.

² All images are intended to illustrate building conditions in compliance with common building codes. However, the images do not take into account site specific conditions, regional building codes and other important information that may require a material change for specific projects. These illustrations do not make representation for fitness for a particular project nor for code or design compliance.

³ UniFormat™ Numbers and Titles used in this publication are from UniFormat™, published by CSI and Construction Specifications Canada (CSC), and are used with permission from CSI. For a more in-depth explanation of UniFormat™ and its use in the construction industry visit <http://www.csinet.org> or contact CSI, 110 South Union Street, Suite 100, Alexandria, VA 22314. (800) 689-2900.

1.2 Intent

1.2.1 Not a set of Requirements

The Specification is not a set of requirements as to what is modeled when or by whom. Rather it is a language by which users can define these requirements for their own firms or projects. This clear articulation allows model authors to define what their models can be relied on for, and allows downstream users to clearly understand the usability and the limitations of models they are receiving.

To accomplish the Specification's intent, its primary objectives are:

- 1) To help teams, including owners, to specify BIM deliverables and to get a clear picture of what will be included in a BIM deliverable
- 2) To help design managers explain to their teams the information and detail that needs to be provided at various points in the design process, and to track progress of their models
- 3) To allow downstream users to rely on specific information in models they receive from others.
- 4) To provide a standard that can be referenced by contracts and BIM execution plans.

1.2.2 Complements a BIM Execution Plan (BIMXP)

This Specification does not replace a project BIMXP, but rather is intended to be used in conjunction with such a plan, providing a means of defining models for specific information exchanges, milestones in a design work plan, and deliverables for specific functions.

1.3 Background

1.3.1 AIA Effort

In 2008, the AIA published its first set of Level of Development definitions in AIA Document *E202™-2008 Building Information Modeling Protocol*. Due to the rapidly evolving nature of the use of BIM, the AIA evaluated the *E202-2008*, including the LOD definitions. The result is the updated and reconfigured Digital Practice documents, *AIA E203™-2013, Building Information Modeling and Digital Data Exhibit*, *AIA G201™-2013, Project Digital Data Protocol Form*, and *AIA G202™-2013, Project Building Information Modeling Protocol Form*, which are accompanied by a detailed guide document entitled *Guide and Instructions to the AIA Digital Practice Documents*. The AIA's updated Digital Practice documents include revised LOD definitions.

1.3.2 BIMForum Effort

In 2011 the BIMForum initiated the development of this LOD Specification and formed a working group comprising contributors from both the design and construction sides of the major disciplines. To help further the standardization and consistent use of the LOD schema, and to increase its usefulness as a foundation for collaboration, the AIA licensed the BIMForum to utilize its latest LOD definitions in this Specification. The BIMForum working group first interpreted the AIA's basic LOD definitions for each building system, and then compiled examples to illustrate the interpretations. Because BIM is being put to an ever increasing number of uses, the group decided that it was beyond the initial scope to address all of them. Instead, the definitions were developed to address model element geometry, with three of the most common uses in mind – quantity take-off, 3D coordination and 3D control and planning. The group felt that in taking this approach the interpretations would be complete enough to support other uses.

1.3.3 LOD Definitions

The LOD definitions that are used in this Specification are identical to those published in the AIA's updated Digital Practice Documents, with two exceptions.

- 1) First, the working group identified the need for an LOD that would define model elements sufficiently developed to enable detailed coordination between disciplines – e.g. clash detection/avoidance, layout, etc. The requirements for this level are higher than those for 300, but not as high as those for 400, thus it was designated LOD 350. The AIA documents do not include LOD 350, but the associated *Guide and Instructions* references it.
- 2) Second, while LOD 500 is included in the AIA's LOD definitions, the working group did not feel it was necessary to further define and illustrate LOD 500 in this Specification because it relates to field verification. Accordingly the expanded descriptions and graphic illustrations in this Specification are limited to LOD 100-400.

2 Levels of Development

2.1 BIM as a Communication Tool

The LOD schema addresses several issues that arise when a BIM is used as a communication or collaboration tool, i.e., when someone other than the author extracts information from it:

- 1) During the design process, building systems and components progress from a vague conceptual idea to a precise description. In the past there has been no simple way to designate where a model element is along this path. The author knows, but others often don't.
- 2) It's easy to misinterpret the precision at which an element is modeled. Hand drawings range from pen strokes on a napkin to hard lines with dimensions called out, and the precision of the drawing can be inferred from its appearance. In a model though, a generic component placed approximately can look exactly the same as a specific component located precisely, so we need something besides appearance to tell the difference.
- 3) It is possible to infer or extract information from a BIM that the author doesn't intend – unconfirmed dimensions can be measured with precision, assembly information often exists before it's been finalized, etc. In the past, this issue has been sidestepped with all-encompassing disclaimers that basically say, "Since some of the information in the model is unreliable, you may not rely on any of it." The LOD framework allows model authors to clearly state the reliability of given model elements, so the concept becomes "Since some of the information in the model is unreliable, you may only rely on it for what I specifically say you can."
- 4) In a collaborative environment, where people other than the model author are depending on information from the model in order to move their own work forward, the design work plan takes on high importance – it is necessary for the model users to know when information will be available in order to plan their work. The LOD framework facilitates this.

The LOD Framework addresses these issues by providing an industry-developed standard to describe the state of development of various systems, assemblies, and components within a BIM. This standard enables consistency in communication and execution by facilitating the detailed definition of BIM milestones and deliverables.

2.2 Level of Development vs. Level of Detail

LOD is sometimes interpreted as Level of *Detail* rather than Level of *Development*. This Specification uses the concept of Level of *Development*. There are important differences.

Level of *Detail* is essentially how *much* detail is included in the model element. Level of *Development* is the *degree to which the element's geometry and attached information has been thought through* – the degree to which project team members may rely on the information when using the model.

In essence, Level of Detail can be thought of as input to the element, while Level of Development is reliable output.

2.3 Fundamental LOD Definitions ⁴

2.3.1 LOD 100

The Model Element may be graphically represented in the Model with a symbol or other generic representation, but does not satisfy the requirements for LOD 200. Information related to the Model Element (i.e. cost per square foot, tonnage of HVAC, etc.) can be derived from other Model Elements.

BIMForum Interpretation: LOD 100 elements are not geometric representations. Examples are information attached to other model elements or symbols showing the existence of a component but not its shape, size, or precise location. Any information derived from LOD 100 elements must be considered approximate.

2.3.2 LOD 200

The Model Element is graphically represented within the Model as a generic system, object, or assembly with approximate quantities, size, shape, location, and orientation. Non-graphic information may also be attached to the Model Element.

BIMForum interpretation: At this LOD elements are generic placeholders. They may be recognizable as the components they represent, or they may be volumes for space reservation. Any information derived from LOD 200 elements must be considered approximate.

⁴ The definitions for LOD 100, 200, 300, 400, and 500 included in this Specification represent the updated language that appears in the AIA's most recent BIM protocol document, *G202–2013, Building Information Modeling Protocol Form*. The LOD 100, 200, 300, 400 and 500 definitions are produced by the AIA and have been used by permission. Copyright © 2013. The American Institute of Architects. All rights reserved. LOD 350 was developed by the BIMForum working group. Copyright © 2013. The BIMForum and the American Institute of Architects. All rights reserved.

2.3.3 LOD 300

The Model Element is graphically represented within the Model as a specific system, object or assembly in terms of quantity, size, shape, location, and orientation. Non-graphic information may also be attached to the Model Element.

BIMForum interpretation: The quantity, size, shape, location, and orientation of the element as designed can be measured directly from the model without referring to non-modeled information such as notes or dimension call-outs.

2.3.4 LOD 350

The Model Element is graphically represented within the Model as a specific system, object, or assembly in terms of quantity, size, shape, location, orientation, and interfaces with other building systems. Non-graphic information may also be attached to the Model Element.

BIMForum interpretation: Parts necessary for coordination of the element with nearby or attached elements are modeled. These parts will include such items as supports and connections. The quantity, size, shape, location, and orientation of the element as designed can be measured directly from the model without referring to non-modeled information such as notes or dimension call-outs.

2.3.5 LOD 400

The Model Element is graphically represented within the Model as a specific system, object or assembly in terms of size, shape, location, quantity, and orientation with detailing, fabrication, assembly, and installation information. Non-graphic information may also be attached to the Model Element.

BIMForum interpretation: An LOD 400 element is modeled at sufficient detail and accuracy for fabrication of the represented component. The quantity, size, shape, location, and orientation of the element as designed can be measured directly from the model without referring to non-modeled information such as notes or dimension call-outs.

2.3.6 LOD 500

The Model Element is a field verified representation in terms of size, shape, location, quantity, and orientation. Non-graphic information may also be attached to the Model Elements.

This Specification does not address LOD 500.

2.4 Example – Light Fixture:

- 100 cost/sf attached to floor slabs
- 200 light fixture, generic/approximate size/shape/location
- 300 Design specified 2x4 troffer, specific size/shape/location
- 350 Actual model, Lightolier DPA2G12LS232, specific size/shape/location
- 400 As 350, plus special mounting details, as in a decorative soffit

3 Using the Specification

3.1 Glossary

The expanded definitions in this Specification use the following interpretations of these terms:

3.1.1 Specific:

The quantity, size, shape, location, and orientation of the element as designed can be measured directly from the model without referring to non-modeled information such as notes or dimension call-outs.

3.1.2 Actual:

The model element includes all the qualities of a specific element and is representative of the manufacturer's model to be installed or the construction intent of an assembly.

3.2 Details

3.2.1 Order of Precedence

The body of this Specification expands on the Fundamental Definitions as they apply to specific building systems and sub-systems. In the event of any conflict, more specific expansions take precedence over less specific expansions and Fundamental Definitions, e.g.

the expanded definitions for C1010 take precedence over those for C10, which in turn take precedence over the Fundamental Definitions.

3.2.2 LOD Definitions as Minimum Requirements

The LODs provide five snapshots of the progression of an element from conceptual to specified – there are many steps in this progression between the defined LODs. The LOD definitions, then, should be considered minimum requirements – i.e. an element has progressed to a given LOD only when all the requirements stated in the definition have been met.

3.2.3 LOD Definitions are Cumulative

For a given element each LOD definition includes the requirements of all previous LODs. Thus for an element to qualify for LOD 300 it must meet all the requirements for 200 and 100 as well as those stated in the LOD 300 definition.

3.2.4 Model Element Author

This document does not prescribe who the author of a particular component at a given LOD should be – the sequence of responsibility for modeling various systems will vary from one project to another. To accommodate this variation this document defers to the concept of Model Element Author (MEA) as defined in the *AIA E203-2013*: “The Model Element Author is the entity (or individual) responsible for managing and coordinating the development of a specific Model Element to the LOD required for an identified Project milestone, regardless of who is responsible for providing the content in the Model Element.”⁵

3.2.5 2D Supplementary Drawings

In current practice models are often supplemented with 2D information such as detail drawings. This Specification does not address this supplementation, but rather deals only with what is actually modeled in 3D and non-graphic information associated with the modeled elements.

3.3 Project-Specific Information

As mentioned in the Overview above, this Specification is intended to be used in conjunction with a project BIMXP. Many information needs will vary from project to project, even for identical elements. This kind of information is therefore not included in the LOD definitions specified here, but rather is left to be addressed in individual BIMXPs. The following are some notable examples.

3.3.1 Size Thresholds

In most projects a determination is made to model certain elements only if they are over a specified size – e.g. conduit less than 1/2” (10 mm) diameter is not modeled. These size thresholds do not consistently correspond to certain LODs, and they vary from project to project. Thus they are not specified in the LOD definitions but rather in the project’s BIMXP, for example through the “Notes” cells in the Model Element Table of the *AIA G202-2013*.

3.3.2 Clearances

Clearances such as door swings, maintenance access zones, and accessibility requirements can be critical design issues and in many cases are geometrically modeled to reserve the space. The implementation of this type of spatial coordination can be accomplished in various ways; therefore it is neither practical nor useful for this Specification to dictate particular requirements, for example, *all door swings to be modeled as quarter-cylinder solids*. Implementation of required clearances is to be established within individual BIMXPs.

3.4 Using the Specification with a BIMXP

Most BIMXPs include a section that details information exchanges – models to be produced to exchange specific information at specific points in a specific BIM use. In most cases, though, current practice is to accompany these models with the common “for reference only” disclaimer, diluting the effectiveness of the exchange. Referencing this Specification in the BIMXP and using it to concisely define the information exchange models brings many efficiencies to the process – among them:

3.4.1 Reliance

As noted above (see “BIM as a Communication Tool”), a major problem with allowing others to rely on a BIM is that it can contain information the author doesn’t intend. By defining a model through the LOD Specification the author can limit reliance to only what he/she specifically states.

3.4.2 Multiple uses

Much model information is common across several information exchanges. This Specification facilitates the definition of models that will support multiple exchanges.

⁵ AIA Document *E203-2013 Building Information Modeling and Digital Data Exhibit*, Article 1.4.6. Copyright © American Institute of Architects 2013. All rights reserved. Definition quoted here by permission.

3.4.3 Efficient sequencing

The development of models as the design and construction process progresses follows logical sequences – much information depending on the prior development of other information. The definition of milestones, information exchanges, and other deliverables through this Specification facilitates the orderly sequencing of models to align with efficient development of information.

3.4.4 Avoidance of over-modeling

The LOD Specification facilitates the application of a pull-planning process to the modeling effort, limiting the development of model elements and information to that which the team identifies as useful.

Note that the definition and sequencing of models usually cannot be set in stone when the BIMXP is first developed. In most cases the modeling plan must evolve as the project progresses.

4 Organization of the Specification

4.1 Geometric and Attribute Information

To facilitate use of this Specification Attachment 1, Model Development Specification (MDS) has been provided. This attachment is a set of spreadsheets that can be used to collect and correlate LOD Information for a specific project.

A model element can contain two types of information: a) the element's geometry and b) associated numeric and/or textual attributes. To address these types of information this Specification contains two parts:

4.1.1 Part A: Element Geometry

Part A consists of narrative descriptions and illustrations of specific model elements at each LOD. Part A forms the bulk of this document.

4.1.2 Part B: Associated Attribute Information

Part B is contained in Attachment 1, a workbook that begins with the Model Element Table which mirrors the layout of the Model Element Table in the AIA *G202-2013 Building Information Modeling Protocol Form*, and can be referenced by that document. The Model Element Table references Attribute Tables that contain attribute information for various building systems.

4.2 Model Element Table

Uniformat Level	Use on this Project	Building Systems	Relevant Attribute Tables	SD			DD			CD			Estimating			LEED Cert.			LEED Cert.			
				Date	LOD	MEA	Notes	Date	LOD	MEA	Notes	Date	LOD	MEA	Notes	Est. 1	Bid	Check	Submittal			
A	10	Substructure	Foundations	A, B Concrete; A, B Wood; A, B Masonry; A, B Precast Concrete																		
A	10	Standard Foundations		A, B Concrete; A, B Wood; A, B Masonry; A, B Precast Concrete																		
A	10	Wall Foundations		A, B Concrete; A, B Wood; A, B Masonry; A, B Precast Concrete																		
A	10	Column Foundations		A, B Concrete; A, B Wood; A, B Masonry; A, B Precast Concrete																		
A	10	Special Foundations		A, B Concrete; A, B Wood; A, B Masonry; A, B Precast Concrete																		
A	10	Grade Beams		A, B Concrete; A, B Wood; A, B Masonry; A, B Precast Concrete																		
A	20	Subgrade Enclosures		A, B Concrete; A, B Wood; A, B Masonry; A, B Precast Concrete																		
A	20	Walls for Subgrade Enclosures		A, B Concrete; A, B Wood; A, B Masonry; A, B Precast Concrete																		
A	40	Slabs-on-Grade		A, B Concrete																		
A	40	Standard Slabs-on-Grade		A, B Concrete																		
A	40	Structural Slabs-on-Grade		A, B Concrete																		
B	10	SHELL																				
B	10	Superstructure																				
B	10	Floor Construction		A, B Cold Formed Metal Framing; A, B Masonry; A, B Metal Deck; A, B Precast Concrete; A, B Steel Joist; A, B Structural Steel; A, B Concrete; A, B Wood																		
B	10	Floor Structural Frame																				
B	10	Concrete		A, B Concrete																		
B	10	Masonry		A, B Masonry																		

Figure 1

4.2.1 Building Systems

The rows of the Model Element Table (Figure 1) are building elements listed in accordance with CSI Uniformat 2010. The table also lists Relevant Attribute Tables for each system, referring to the tabs containing attribute information for the associated system(s). If desired users can add Attribute Tables for specific line items.

4.2.2 Milestones/Deliverables

The table includes columns for defining the LODs for various milestones within a project. Each milestone column has three sub-columns: Level of Development (LOD), Model Element Author (MEA), and Notes. The table in Attachment 1 shows standard milestones for the completion of the traditional design phases as well as examples of Project-Specific Milestones for interim reviews, specific deliverables, BIM-Use information exchanges, etc. Users are encouraged to modify and add to these milestones as necessary. Once the milestones for a project have been determined, they can be re-ordered into a logical sequence as in Figure 2.

Uniformat Level	1	2	3	4	Use on this project	Relevant Attribute Tables	SD			Estimating			DD			LEED Cert.			CD			Estimating			LEED Cert		
							Date	MEA	Notes	Date	MEA	Notes	Date	MEA	Notes	Date	MEA	Notes	Date	MEA	Notes	Date	MEA	Notes	Date	MEA	Notes
SUBSTRUCTURE																											
A	10					Foundations	A, B Concrete, A, B Wood, A, B Masonry, A, B Precast Concrete																				
A	10	10				Standard Foundations	A, B Concrete, A, B Wood, A, B Masonry, A, B Precast Concrete																				
A	10	10	.10			Wall Foundations	A, B Concrete, A, B Wood, A, B Masonry, A, B Precast Concrete																				
A	10	10	.30			Column Foundations	A, B Concrete, A, B Wood, A, B Masonry, A, B Precast Concrete																				
A	10	20				Special Foundations	A, B Concrete, A, B Wood, A, B Masonry, A, B Precast Concrete																				
A	10	20	.80			Grade Beams	A, B Concrete, A, B Wood, A, B Masonry, A, B Precast Concrete																				
A	20					Subgrade Enclosures	A, B Concrete, A, B Wood, A, B Masonry, A, B Precast Concrete																				
A	20	10				Walls for Subgrade Enclosures	A, B Concrete, A, B Wood, A, B Masonry, A, B Precast Concrete																				
A	40					Slabs-on-Grade	A, B - Gr. Concrete																				
A	40	10				Standard Slabs-on-Grade	A, B Concrete																				
A	40	20				Structural Slabs-on-Grade	A, B Concrete																				
SHELL																											
B	10					Superstructure																					
B	10	10				Floor Construction	A, B Cold Formed Metal Framing, A, B Masonry, A, B Metal Deck, A, B Precast Concrete, A, B Steel Joist, A, B Structural Steel, A, B Concrete, A, B Wood																				
B	10	10	.10			Floor Structural Frame																					
B	10	10	.10			Concrete	A, B Concrete																				
B	10	10	.10			Masonry	A, B Masonry																				

Figure 2

4.3 Attribute Tables

B - Ext. Glazed Openings					Part 1 - Attribute Description					Part 2 - LOD Profile					Part 3 - Project-Specific Milestones (Examples)			
Date Type		Units	Option Examples		Commentary					100	200	300	350	400	Estimating Est. 1	Estimating Bid Pkg.	LEED Cert. Check	LEED Cert. Submittal
Construction			options [Unitized (combined glass and frame), Stick Built, Structural Glass]								x	x	x	x				
Material			options [Aluminum Framed, Bronze Framed, Stainless Steel Framed, Channel Glass]										x	x	x			
Thermal Resistance		Number	R-Value										x	x	x			
Condensation Resistance				options [see, no, class]														
Windborne Debris Resistance			psf															
Wind Load Capacity			psf															
Glazing Method				options [Conventional, Two Sided, Three Sided, Four Sided, Piv Supported]														
Glass - Material				options [Glass, Plastic]														
Glass - Configuration				options [Monolithic, Insulating]														
Glass - Condition				options, multiple [Annealed, Heat Strengthened, Tempered, Laminated, Bore]														
Glass - Coatings				options, multiple [Purified (hard coat), Sputter (soft coat), Low E, Metallic, Ceramic, Flat, Open Coat, Digital Primed]														

Figure 3

4.3.1 Attribute Table Anatomy

Attribute Tables consist of three parts.

- 1) Part 1, Attribute Description, lists Attributes relevant to the associated building system(s).
- 2) Part 2, LOD Profile, correlates Attribute requirements with LODs from the Model Element Table. Attributes with pre-populated LOD Profiles show a correlation between Attributes and LODs that represents current practices of proficient BIM users.
- 3) Part 3, Milestones, is used to mark the attributes required for specific milestones and deliverables. The tables in Attachment 1 include example milestones, but users will customize the tables by copying the milestones they created for the Model Element Table.

4.3.2 MEP Attribute Tables

The MEP attribute tables use a somewhat different format than other sections, since components from multiple systems might be used to make up a specific element. Case in point, an air handler is primarily a D30 HVAC element, but can include plumbing, fire protection and electrical elements as well.

D20 - Plumbing					
Part 1 - Attribute Description		Part 2 - LOD Profile			
Global Attributes					
XXXXXXXX		X	X	X	X
XXXXXXXX		X	X	X	X
XXXXXXXX		X	X	X	X
XXXXXXXX		X	X	X	X
XXXXXXXX				X	X
XXXXXXXX				X	X
XXXXXXXX				X	X
XXXXXXXX				X	X
XXXXXXXX				X	X
XXXXXXXX				X	X
Fixture-Specific Attributes					
Waste Trap					
XXXXXXXX			X	X	X
XXXXXXXX		X	X	X	X
XXXXXXXX		X	X	X	X
XXXXXXXX					
Water Filter					
XXXXXXXX		X	X	X	X
XXXXXXXX		X	X	X	X
Flow Meter					
XXXXXXXX		X	X	X	X
XXXXXXXX		X	X	X	X
XXXXXXXX					
Gas Meter					
XXXXXXXX		X	X	X	X
XXXXXXXX		X	X	X	X
Water Meter					
XXXXXXXX		X	X	X	X
XXXXXXXX				X	X
XXXXXXXX				X	X

Figure 4

The MEP Systems tabs are grouped into two types:

- 1) Type 1 – source or end elements and controllers: D20 Plumbing, D30 HVAC, D40 Fire Protection and D50 Electrical.
- 2) Type 2 – distribution elements such as ducts, pipes, and cables: D Air Distribution, D Fluid Gas Distribution and D Electrical Distribution relate to distribution elements such as ducts, pipes, and cables.

MEP attribute tables are broken down into two main sections

- 3) Common Attributes: Attributes that are common to all elements within the table
- 4) Specific Attributes: Attributes that are specific to an individual type of element within the table. In many tables the Individual elements are organized into a hierarchy of classes and sub-classes. In these cases the attributes needed for a specific element include those listed for the element itself plus those listed in any of the classes above it in the hierarchy. E.g. as Figure 4 shows, the basic attributes for a water meter include all those shown in bold.

Note: The Type 1 attributes use both the Common and Specific attributes section, while the Type 2 attributes use only the Specific attribute section.

4.3.3 Using the Attribute Tables

There are many ways to use the Attribute Tables – three are shown here.

- 1) Project teams adopt the pre-populated attribute lists – using only those attributes with entries in the LOD Profile sections and leaving those entries unchanged. The pre-populated correlation between Attributes and LODs represents current practices of proficient BIM users in the AEC industry.
- 2) Project teams create a custom correlation between LODs and Attribute population requirements. In this case the project team would edit the LOD Profile section to reflect the specific requirements of the project.
- 3) Project teams create new, project specific milestones and define Attribute population requirements in the Milestones sections. This approach will give project teams the greatest flexibility for defining Attribute population requirements.

5 Updates of This Document

While this document is intended as a reference that can be cited in agreements such as contracts and BIM execution plans, it is recognized that the use of BIM in design and construction is evolving. To accommodate this evolution this document will be updated periodically in clearly identifiable versions. A project can adopt a specific version and then has the option to remain with that version or update if a new version is published. Initially the target update frequency is annually, but that may change in the future. In addition, interim updates may be issued if needed.

5.1 Revision History

10/30/15	Level of Development Specification 2015	New changes are noted with a bold bar. Definitions have not been changed except for minor grammatical corrections and formatting. New content released as an Appendix to Part A for engineered metal building structures, precast concrete, highway bridge content and rail road bridge content.
4/30/15	Level of Development Specification 2015 DRAFT FOR PUBLIC COMMENT	New changes are noted with a bold bar. Definitions have not been changed except for minor grammatical corrections and formatting. Part B, Model Element Table, and Attribute Tables were added.

12/30/14	Level of Development Specification 2014	New changes are noted with a bold bar. Definitions have not been changed except for minor grammatical corrections and formatting. Images and image notes have been added in <i>blue italics font</i> .
8/22/13	Level of Development Specification 2013	
4/24/13	Initial draft for public review	

5.2 Revision Process

5.2.1 Public Comment

Each new version is first released as a draft for public comment. Feedback is evaluated and resolved prior to the publishing of the official version.

5.2.2 Appendix

An increasing number of professional organizations are adopting this Specification and providing additional content relating to their domains. To accommodate information that becomes available after the public-comment release but prior to the final release, content is developed in collaboration with industry organizations and leading expert practitioners, and then vetted by the LOD working group. This content is released as an Appendix to Part A and as additional identified Attribute Table tabs in Part B. The new content is then integrated into the next public comment draft.

A: SUBSTRUCTURE

A10 Foundations

100	Assumptions for foundations are included in other modeled elements such as an architectural floor element or volumetric mass that contains layer for assumed structural framing depth. Or, schematic elements that are not distinguishable by type or material. Assembly depth/thickness and locations still flexible.	
200	Element modeling to include: <ul style="list-style-type: none"> • Approximate size and shape of foundation element • Structural building grids for local project coordinate system are defined in model and coordinated with global civil coordinate system (State Plane Coordinate System, etc). 	

A1010 – Standard Foundations

100	See A10	
200	See A10	
300	Elements are modeled to the design-specified size and shape of the foundation. Element modeling to include: <ul style="list-style-type: none"> • Overall size and geometry of the foundation element • Sloping surfaces or floor depressions • External dimensions of the members Required non-graphic information associated with model elements includes: <ul style="list-style-type: none"> • Concrete strength • Reinforcing strength 	

A1010.10 – Wall Foundations (Shallow Foundations)

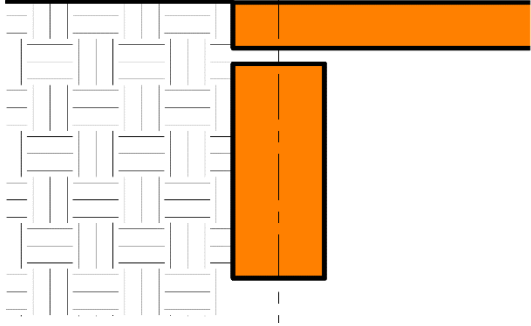
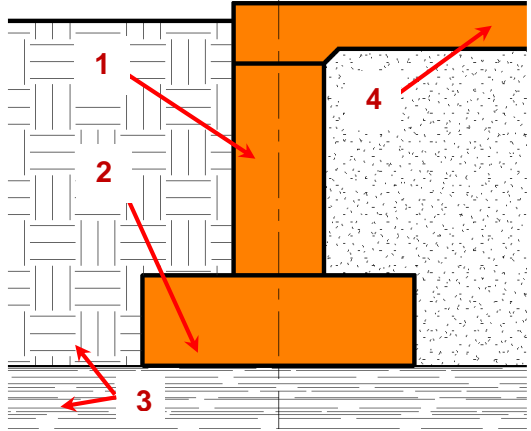
100	See A10	
200	<p>See A10</p> <p><i>Image Notes:</i></p> <ol style="list-style-type: none"> 1) <i>Generic wall foundation is modeled.</i> 2) <i>Site is generically modeled from geotechnical information in geotechnical report.</i> 	 <p>5 A1010.10-LOD-200 Wall Foundation</p>
300	<p>See A1010</p> <p>Element modeling to include:</p> <ol style="list-style-type: none"> 1) Overall size and geometry of the foundation element 2) Sloping surfaces. 3) External dimensions of the members <p>Required non-graphic information associated with model elements includes:</p> <ol style="list-style-type: none"> 4) Concrete strength 5) Reinforcing strength 6) Geotechnical bearing strata elevation is modeled from geotechnical report. <p><i>Image Notes:</i></p> <ol style="list-style-type: none"> 1) <i>Wall foundation sizes are accurately modeled with footings where applicable.</i> 2) <i>Bearing elevation is modeled from the geotechnical report.</i> 3) <i>Geotechnical regions are shown for context and not required to be modeled as part of this element at this LOD.</i> 4) <i>See slab on grade for related conditions at this LOD.</i> 	 <p>6 A1010.10-LOD-300 Wall Foundation</p>

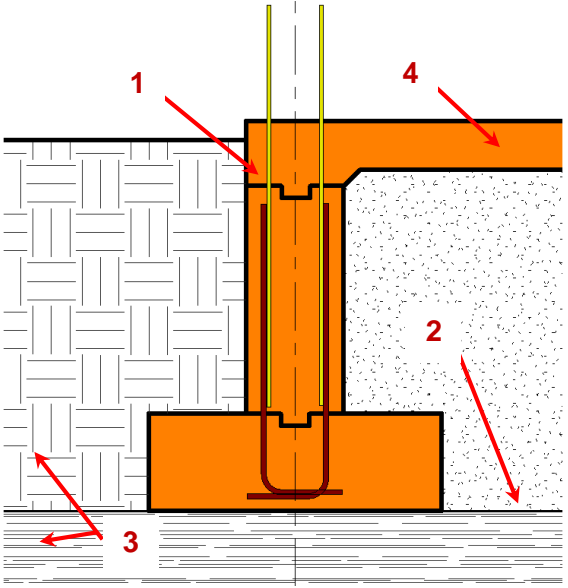
<p>350</p>	<p>Element modeling to include:</p> <ul style="list-style-type: none"> • Location of sleeve penetrations • Pour joints • Moisture retarder • Dowels • All exposed embeds or reinforcement such as lintels • Expansion joints • Geotechnical Bearing Strata is modeled from geotechnical report estimates. <p><i>Image Notes:</i></p> <ol style="list-style-type: none"> 1) <i>Grade beam sizes are modeled with interfaces to other systems such as but not limited to slab turn downs, key-ways between concrete pours, construction joints and reinforcing dowels into adjacent pours.</i> 2) <i>Bearing elevation is modeled from the geotechnical report with the addition on interface elements such as void boxes where applicable.</i> 3) <i>Geotechnical regions are shown for context and not required to be modeled as part of this element at this LOD.</i> 4) <i>See slab on grade for related conditions at this LOD.</i> 	 <p>7 A1010.10-LOD-350 Wall Foundations (Shallow Foundations)</p>
<p>400</p>	<p>Element modeling to include:</p> <ul style="list-style-type: none"> • Rebar including hooks and lap splices • Dowels • Chamfer • Finish • Coursing for unit masonry defined • Waterproofing 	

A1010.30 – Column Foundations (Deep Foundations)

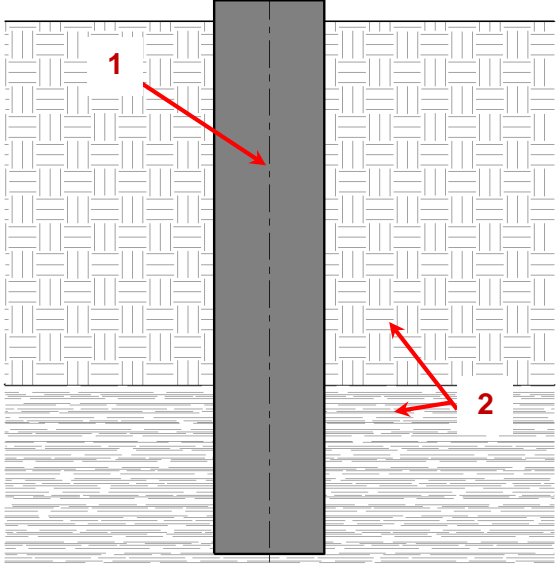
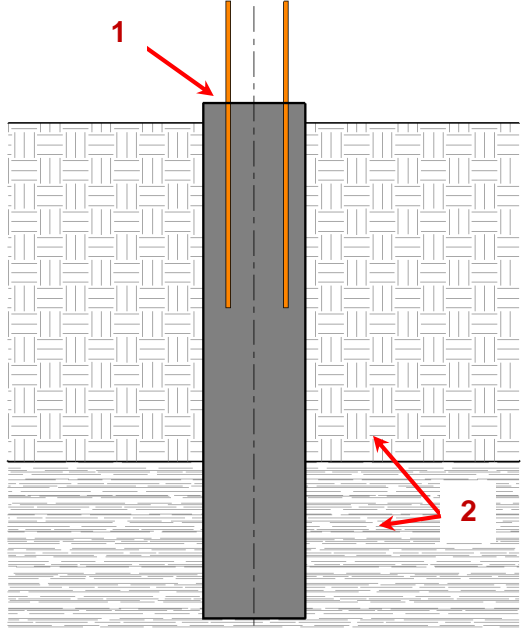
100	See A10	
200	See A10	
300	<p>Element modeling to include:</p> <ul style="list-style-type: none"> Assumed bearing depth per geotechnical report with designed penetration geometry modeled. Top of Pier Size of Pier <p><i>Image Notes:</i></p> <ol style="list-style-type: none"> Pier sizes are accurately modeled with top of pier elevation, estimated depth to bearing and specified depth of penetration into bearing strata. Geotechnical regions are shown for context and not required to be modeled as part of this element at this LOD. 	 <p>8 A1010.30-LOD-300 Column Foundations (Deep Foundations)</p>
350	<p>Element modeling to include:</p> <ul style="list-style-type: none"> Actual Top of Pier (TOP) and expected Bottom of Pier (BOT) modeled per engineers review of site conditions Foundation dowel locations and anchor rods if applicable. <p><i>Image Notes:</i></p> <ol style="list-style-type: none"> Pier sizes are accurately modeled with interfaces to other systems such as but not limited to slab turn downs, key-ways between concrete pours, construction joints and reinforcing dowels into adjacent pours. Geotechnical regions are shown for context and not required to be modeled as part of this element at this LOD. 	 <p>9 A1010.30-LOD-350 Column Foundations</p>

400

Element modeling to include:

- Depth to bearing stratum
- Penetration into bearing stratum
- Locations of lap splices
- Rebar detailing including hooks and lap splices
- Dowels
- Pier sled or Pier wheel for side clear cover
- Pier bolster for bottom clear cover

Image Notes:

- 1) *Pier modeling is developed to include all fabrication content that is part of the element.*
- 2) *Geotechnical regions are shown for context and not required to be modeled as part of this element at this LOD.*
- 3) *Pier sled, pier wheel, pier bolsters and other related items are not shown in image for clarity.*

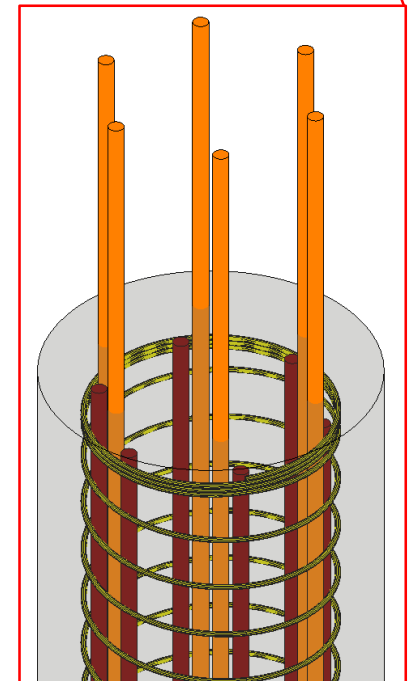
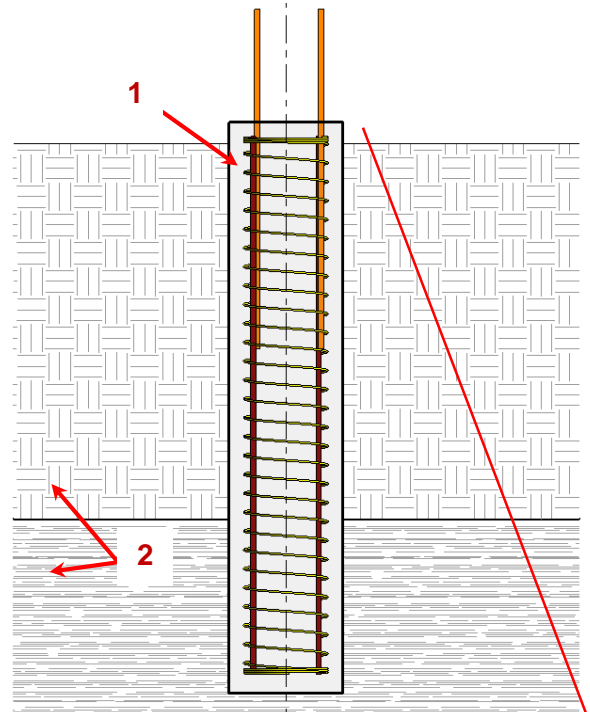

10 A1010.30-LOD-400 Column Foundations

A1020 – Special Foundations

Includes: Drilling, casing, bell bottom, excavation, dewatering, removal of excavated materials, reinforcing, and concrete. Drilled Piers, Driven Piles, Mat Foundation.

100	See A10	
200	See A10	
300	See A1010	
350	Element modeling to include: <ul style="list-style-type: none">• Location of sleeve penetrations• Pour joints• Moisture retarder• Dowels• All elements needed for cross-trade collaboration are to be modeled• Actual location and shape of structural element• Exposed embeds or reinforcement such as lintels• Penetrations detailed and modeled• Expansion joints	
400	Element modeling to include: <ul style="list-style-type: none">• Rebar detailing including hooks and lap splices• Dowels• Chamfer• Finish• Coursing for unit masonry defined• Waterproofing	

A1020.80 – Grade Beams

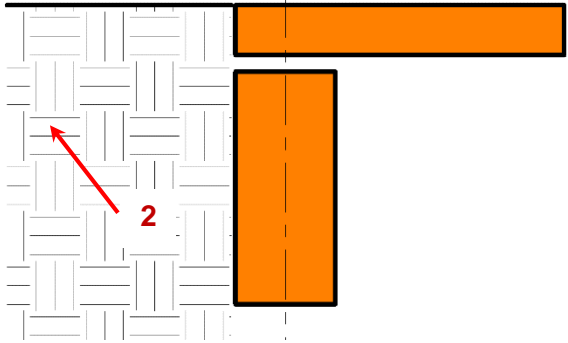
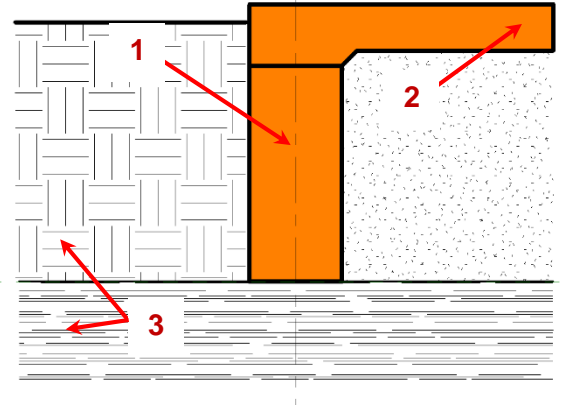
100	See A10	
200	See A10 <i>Image Notes:</i> <ol style="list-style-type: none">1) Generic beam geometry is shown.2) Geotechnical regions are shown for context and not required to be modeled as part of this element at this LOD.	 <p>11 A1020.80-LOD-200 Grade Beams</p>
300	See A1010 <i>Image Notes:</i> <ol style="list-style-type: none">1) Grade beam sizes are shown accurately.2) See slab on grade for related conditions at this LOD.3) Geotechnical regions are shown for context and not required to be modeled as part of this element at this LOD.	 <p>12 A1020.80-LOD-300 Grade Beams</p>

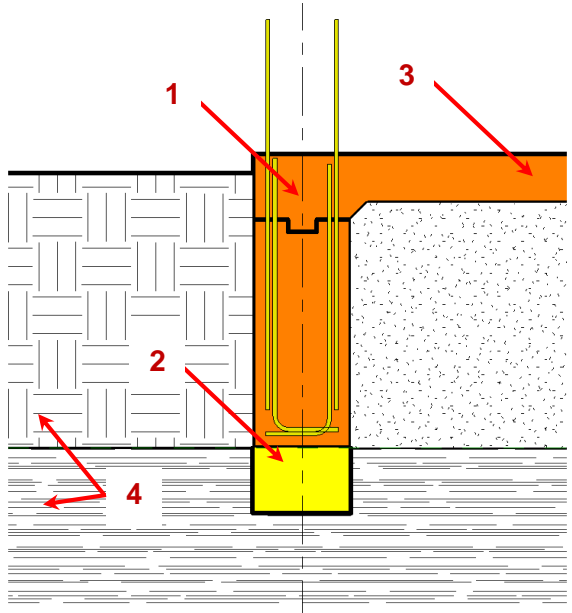
<p>350</p>	<p>Element modeling to include:</p> <ol style="list-style-type: none"> 1) Water stops 2) Pour joints and sequences required to identify reinforcing lap splice, scheduling, etc. <p>Required non-graphic information associated with model elements includes:</p> <ol style="list-style-type: none"> 3) Post-tension profile and strands if required by the BIMXP. <p><i>Image Notes:</i></p> <ol style="list-style-type: none"> 1) <i>Grade beam sizes are modeled with interfaces to other systems such as but not limited to slab turn downs, key-ways between concrete pours, construction joints and reinforcing dowels into adjacent pours.</i> 2) <i>Interface elements such as void boxes are modeled where applicable.</i> 3) <i>See slab on grade for related conditions at this LOD.</i> 4) <i>Geotechnical regions are shown for context and not required to be modeled as part of this element at this LOD.</i> 	 <p>13 A1020.80-LOD-350 Grade Beams</p>
<p>400</p>	<p>Element modeling to include:</p> <ul style="list-style-type: none"> • Detailed post-tensioned components 	

A20 Subgrade Enclosures

<p>100</p>	<p>Solid mass model representing overall building volume; or, schematic wall elements that are not distinguishable by type or material.</p> <p>Assembly depth/thickness and locations still flexible.</p>	
<p>200</p>	<p>Element modeling to include:</p> <ul style="list-style-type: none"> • Approximate size and shape of the subgrade enclosure element. • Structural building grids for local project coordinate system are defined in model and coordinated with global civil coordinate system (State Plane Coordinate System, etc). 	

A2010 – Walls for Subgrade Enclosures

100	See A20	
200	See A20	
300	<p>Element modeling to include:</p> <ul style="list-style-type: none"> • Overall size and geometry of the subgrade element • Sloping surfaces • External dimensions of the element • Material strength <p>Required non-graphic information associated with model elements includes:</p> <ul style="list-style-type: none"> • Concrete strength • Reinforcing Strength • Air entrainment • Finishes 	
350	<p>Element modeling to include:</p> <ul style="list-style-type: none"> • Chamfers • Sleeve penetrations • Pour joints • Rebar and any embedded elements modeled at congested areas where specified by project BIMXP which is typically within a set distance from the area of congestion. • Any permanent shoring or forming structures such as void boxes • Interior finish and/or insulation • Expansion joints • Moisture retarder • Exposed embeds or reinforcement such as lintels • Penetrations detailed and modeled • Expansion joints 	
400	<p>Element modeling to include:</p> <ul style="list-style-type: none"> • Rebar including hooks and lap splices • Dowels • Chamfer • Finish • Coursing for unit masonry defined • Waterproofing 	

A40 Slabs-on-Grade

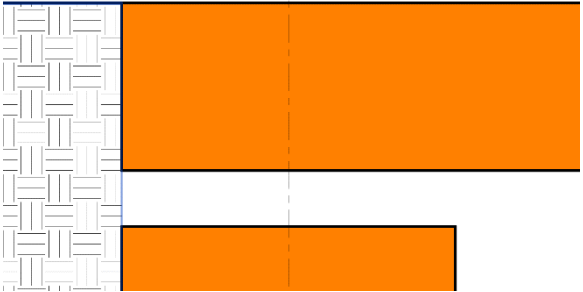
100	Assumptions for slabs are included in other modeled elements such as a volumetric mass or architectural floor element that contains a layer for assumed structural framing depth.	
200	<p>Element modeling to include</p> <ul style="list-style-type: none"> • Generic slab with approximate thickness. • Structural building grids for local project coordinate system are defined in model and coordinated with global civil coordinate system (State Plane Coordinate System, etc). 	 <p>14 A40-LOD-200 Slabs-on-Grade</p>

A4010 – Standard Slabs-on-Grade

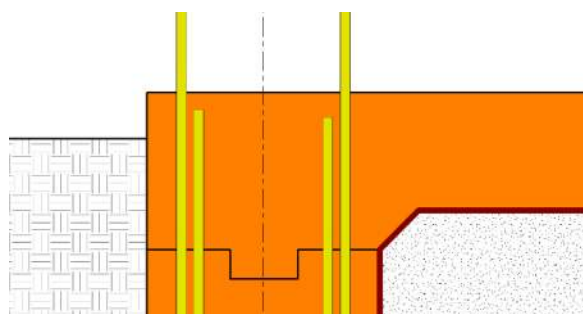
100	See A40	
200	See A40	
300	<p>Element modeling to include:</p> <ul style="list-style-type: none"> • Overall size, thickness and geometry of the slab • Slab depressions • Edge turn downs • Material strength • All sloping surfaces included in model element with exception of elements affected by manufacturer selection. <p>Required non-graphic information associated with model elements includes:</p> <ul style="list-style-type: none"> • Moisture retarder • Air entrainment 	 <p>15 A4010-LOD-300 Standard Slabs-on-Grade</p>
350	<p>Element modeling to include:</p> <ul style="list-style-type: none"> • Sleeve penetrations • Pour joints • Control joints • Expansion joints • Water stops • Rebar and any embedded elements modeled at congested areas where specified by project BIMXP which is typically with in a set distance from the area of congestion. • Void boxes • Anchor rods • Moisture retarder • Dowels • Post-tension profile and strands if required by the BIMXP. 	 <p>16 A4010-LOD-350 Standard Slabs-on-Grade</p>

400	Element modeling to include: <ul style="list-style-type: none">• Actual slab dimensions and profiles with fully modeled rebar• Post tensioning components• All joints• Water proofing• Finish	
-----	---	--

A4020 – Structural Slabs-on-Grade

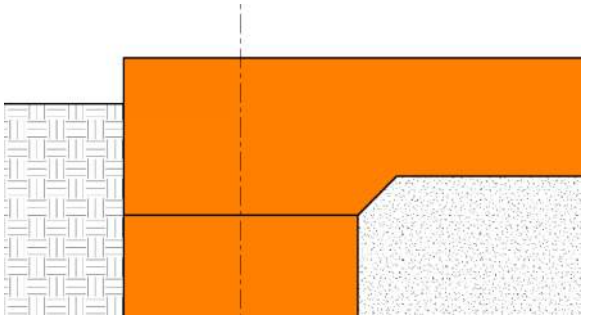
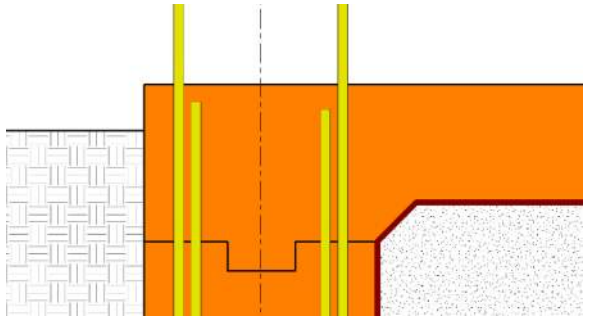
100	See A40	
200	See A40	
300	<p>Element modeling to include:</p> <ul style="list-style-type: none"> • Overall size, thickness and geometry of the slab-on-grade • Slab depressions • Edge turn downs • Material strength • All sloping surfaces included in model element with exception of elements affected by manufacturer selection which are not known at this LOD. Such conditions could include floor geometry differences where different <u>specified</u> manufacturers will not be known until the <u>actual</u> system is selected. <p>Required non-graphic information associated with model elements includes:</p> <ul style="list-style-type: none"> • Concrete strength • Reinforcing strength • Air entrainment • Moisture Retarder • Slab penetrations 	 <p><i>17 A4020-LOD-300 Structural Slabs-on-Grade</i></p>
350	<p>Element modeling to include:</p> <ul style="list-style-type: none"> • Sleeve penetrations • Pour joints • Control joints • Expansion joints • Water Stops • Rebar and any embedded elements modeled at congested areas where specified by project BIMXP which is typically within a set distance from the area of congestion. • Void boxes • Anchor rods • Moisture retarder • Dowels • Post-tension profile and strands modeled if required by the BIMXP 	 <p><i>18 A4020-LOD-350 Structural Slabs-on-Grade</i></p>
400	<p>Element modeling to include:</p> <ul style="list-style-type: none"> • Actual slab dimensions and profiles with fully modeled rebar • Post tensioning components • All joints • Water proofing • Finish 	

B: SHELL

B10 Superstructure

100	<p>Assumptions for structural framing are included in other modeled elements such as an architectural floor element that contains a layer for assumed structural framing depth; or, schematic structural elements that are not distinguishable by type or material.</p> <p>Assembly depth/thickness or component size and locations still flexible.</p>	
-----	---	--

B1010 – Floor Construction

100	See B10	
200	<p>Model elements to include:</p> <ul style="list-style-type: none"> • Floor with approximate dimensions • Approximate supporting framing members • Structural grids defined 	

B1010.10 – Floor Structural Frame

Description: Structural elements required for support of floor construction within basements and above grade. Includes columns, girders, beams, trusses, joists. Includes cast-in-place concrete, precast concrete, unit masonry, metal framed, and wood framed systems. Includes framed and sleeved openings for services. Includes Floor Construction Supplementary Components as appropriate.

Specific structural systems within this section are listed as follows:

- [Concrete](#)
- [Masonry](#)
- [Steel Framing Columns](#)
- [Steel Framing Beams](#)
- [Steel Framing Bracing Rods](#)
- [Steel Joists](#)
- [Cold-Formed Metal Framing](#)
- [Wood Floor Trusses](#)



B1010.10 – Floor Structural Frame (Concrete)

100	See B10	
200	<p>Element modeling to include:</p> <ul style="list-style-type: none"> Type of structural concrete system Approximate geometry (e.g. depth) of structural elements 	
300	<p>Element modeling to include:</p> <ul style="list-style-type: none"> Specific sizes and locations of main concrete structural members modeled per defined structural grid with correct orientation Concrete defined per spec (strength, air entrainment, aggregate size, etc.) All sloping surfaces included in model element with exception of elements affected by manufacturer selection <p>Required non-graphic information associated with model elements includes:</p> <ul style="list-style-type: none"> Penetrations for items such as MEP Finishes, camber, chamfers, etc. Typical details Embeds and anchor rods Aggregate, clear cover Reinforcing spacing Reinforcing Live loads Shear reinforcing and stud rails 	
350	<p>Element modeling to include:</p> <ul style="list-style-type: none"> Reinforcing Post-tension profiles and strand locations Reinforcement called out, modeled if required by the BIMXP, typically only in congested areas Pour joints and sequences to help identify reinforcing lap splice locations, scheduling, etc. Expansion Joints Embeds and anchor rods Post-tension profile and strands modeled if required by the BIMXP Penetrations for items such as MEP Any permanent forming or shoring components Shear reinforcing and stud rails 	
400	<p>Element modeling to include:</p> <ul style="list-style-type: none"> All reinforcement including post tension elements detailed and modeled Finishes, camber, chamfer, etc. 	

B1010.10 – Floor Structural Frame (Masonry)

100	See B10	
200	Element modeling to include: <ul style="list-style-type: none"> • Type of structural masonry system 	
300	Element modeling to include: <ul style="list-style-type: none"> • Specific sizes of main structural elements modeled per defined structural grid with correct dimensions • Rough openings with reinforcement and lintels called out Required non-graphic information associated with model elements includes: <ul style="list-style-type: none"> • Reinforcing • Mortar and grout defined • Reinforcement and steel lintels required at openings • Penetrations for items such as MEP 	
350	Element modeling to include: <ul style="list-style-type: none"> • Actual location and shape of structural masonry element • All exposed embeds or reinforcement such as lintels • All penetrations detailed and modeled • Expansion joints 	
400	Element modeling to include: <ul style="list-style-type: none"> • Waterproofing • Coursing • Reinforcing • Grout 	

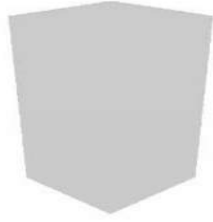
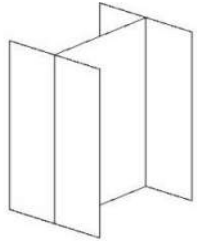
B1010.10 – Floor Structural Frame (Steel Framing Columns)

100	Generic column element, See B10 .	 <p><i>19 B1010.10-LOD-100 Floor Structural Frame (Steel Framing Columns)</i></p>
200	See B1010	 <p><i>20 B1010.10-LOD-200 Floor Structural Frame (Steel Framing Columns)</i></p>
300	<p>Element modeling to include:</p> <ul style="list-style-type: none"> • Specific sizes of main vertical structural members modeled per defined structural grid with correct orientation <p>Required non-graphic information associated with model elements includes:</p> <ul style="list-style-type: none"> • Structural steel materials defined. • Connection details • Finishes, i.e. painted, galvanized, etc. 	 <p><i>21 B1010.10-LOD-300 Floor Structural Frame (Steel Framing Columns)</i></p>
350	<p>Element modeling to include:</p> <ul style="list-style-type: none"> • Actual elevations and location of member connections • Large elements of typical connections applied to all structural steel connections such as base plates, gusset plates, anchor rods, etc. • Any miscellaneous steel members with correct orientation • Any steel structure reinforcement such as web stiffeners, sleeve penetrations, etc. 	 <p><i>22 B1010.10-LOD-350 Floor Structural Frame (Steel Framing Columns)</i></p>

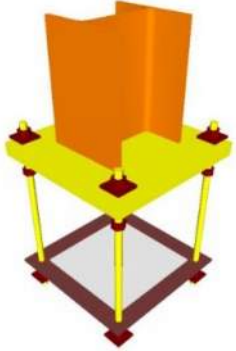
400	<p>Element modeling to include:</p> <ul style="list-style-type: none">• Welds• Coping of members• Cap plates• Washers, nuts, etc.• All assembly elements	 <p><i>23 B1010.10-LOD-400 Floor Structural Frame (Steel Framing Columns)</i></p>
-----	--	--

B1010.10 – Floor Structural Frame (Steel Framing Beams)

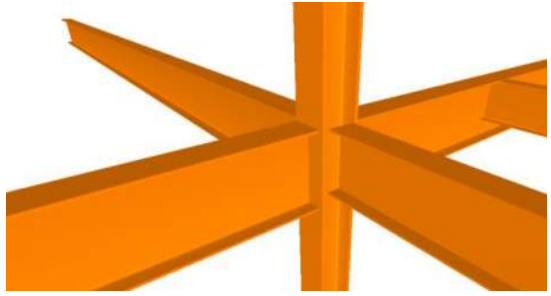
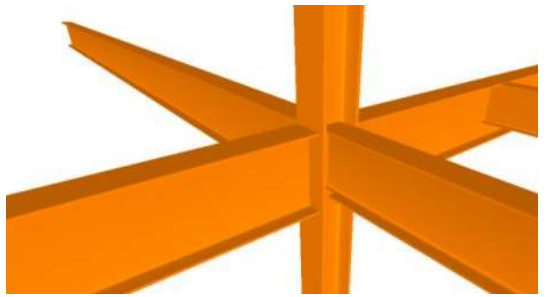
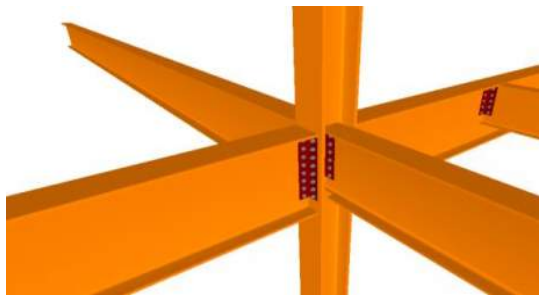
100	See B10	
200	See B1010	
300	<p>Element modeling to include:</p> <ul style="list-style-type: none"> • Specific sizes of main horizontal structural members modeled per defined structural grid with correct orientation, slope and elevation <p>Required non-graphic information associated with model elements includes:</p> <ul style="list-style-type: none"> • Structural steel materials defined • Connection details • Finishes, i.e. painted, galvanized, etc. 	 <p><i>24 B1010.10-LOD-300 Floor Structural Frame (Steel Framing Beams)</i></p>
350	<p>Element modeling to include:</p> <ul style="list-style-type: none"> • Actual elevations and location of member connections • Large elements of typical connections applied to all structural steel connections such as base plates, gusset plates, anchor rods, etc. • Any miscellaneous steel members with correct orientation • Any steel structure reinforcement such as web stiffeners, sleeve penetrations, etc. 	 <p><i>25 B1010.10-LOD-350 Floor Structural Frame (Steel Framing Beams)</i></p>
400	<p>Element modeling to include:</p> <ul style="list-style-type: none"> • Welds • Coping of members • Bent plates, cap plates, etc. • Bolts, washers, nuts, etc. • All assembly elements 	 <p><i>26 B1010.10-LOD-400 Floor Structural Frame (Steel Framing Beams)</i></p>

B1010.10 – Floor Structural Frame (Steel Framing Miscellaneous Members)

100	See B10	
200	See B1010	
300	<p>Element modeling to include:</p> <ul style="list-style-type: none"> • Specific sizes of main horizontal structural members modeled per defined structural grid with correct orientation, slope and elevation <p>Required non-graphic information associated with model elements includes:</p> <ul style="list-style-type: none"> • Structural steel materials defined • Connection details • Finishes, i.e. painted, galvanized, etc. 	
350	<p>Element modeling to include:</p> <ul style="list-style-type: none"> • Actual elevations and location of member connections • Large elements of typical connections applied to all structural steel connections such as base plates, gusset plates, anchor rods, etc. • Any miscellaneous steel members with correct orientation • Any steel structure reinforcement such as web stiffeners, sleeve penetrations, etc. 	
400	<p>Element modeling to include:</p> <ul style="list-style-type: none"> • Welds • Coping of members • Cap plates • Washers, nuts, etc. • All assembly elements 	

B1010.10 – Floor Structural Frame (Steel Framing Bracing Rods)

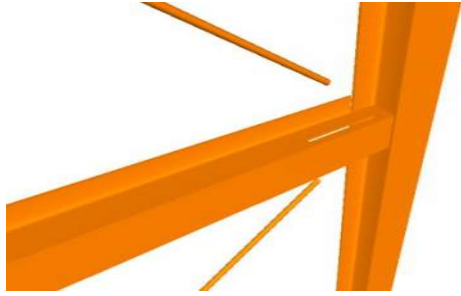
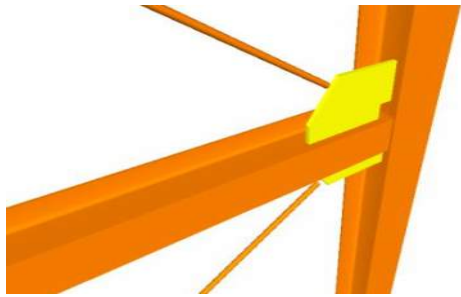
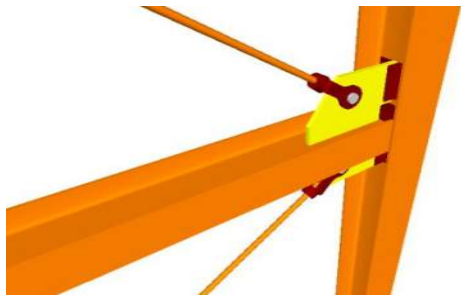
100	See B10	
200	See B1010	
300	<p>Element modeling to include:</p> <ul style="list-style-type: none"> • Specific sizes of main structural braces modeled per defined structural grid <p>Required non-graphic information associated with model elements includes:</p> <ul style="list-style-type: none"> • Structural steel materials 	 <p>27 B1010.100-LOD-300 Floor Structural Frame (Steel Framing Bracing Rods)</p>
350	<p>Element modeling to include:</p> <ul style="list-style-type: none"> • Connection details • Actual elevations and location of member connections • Large elements of typical connections applied to all structural steel connections such as base plates, gusset plates, anchor rods, etc. • Any miscellaneous steel members with correct orientation 	 <p>28 B1010.100-LOD-350 Floor Structural Frame (Steel Framing Bracing Rods)</p>
400	<p>Element modeling to include:</p> <ul style="list-style-type: none"> • Welds • Clevis • Bolts, washers, nuts, etc. • All assembly elements 	 <p>29 B1010.100-LOD-400 Floor Structural Frame (Steel Framing Bracing Rods)</p>

B1010.10 – Floor Structural Frame (Steel Joists)

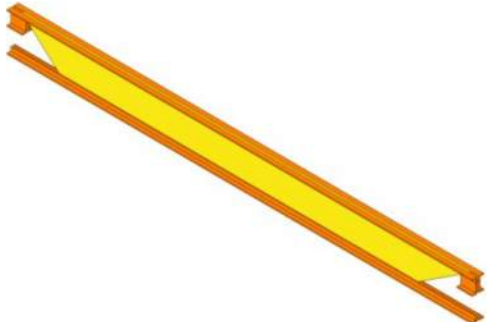
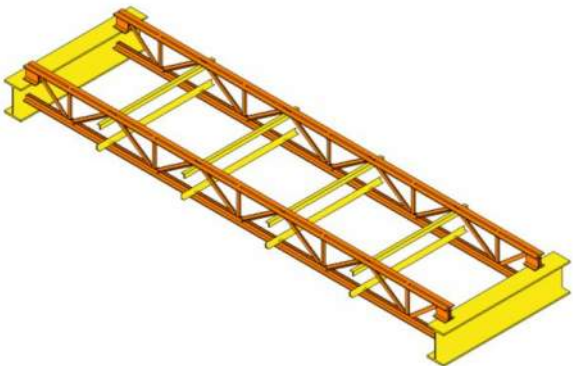
100	See B10	
200	<p>Element modeling to include:</p> <ul style="list-style-type: none"> • Approximate depth 	 <p><i>30 B1010.10-LOD-200 Floor Structural Frame (Steel Joists)</i></p>
300	<p>Element modeling to include:</p> <ul style="list-style-type: none"> • Joist size, depth, slope, and material • Spacing and end elevations • Joist seat depth <p>Required non-graphic information associated with model elements includes:</p> <ul style="list-style-type: none"> • Non-standard joist seat depths and/or sloping joist seat • Member designation, load capacity and deflection criteria • Design loads and location of concentrated loads • Material requirements 	 <p><i>31 B1010.10-LOD-300 Floor Structural Frame (Steel Joists)</i></p>
350	<p>Element modeling to include, information needed for cross trade collaboration such as:</p> <ul style="list-style-type: none"> • Actual final joist profile locations with accurate panel points • Joist bridging and lateral braces. • Fire protection coating • Any miscellaneous steel pertaining to the joist • Joist seat width • Erection details for installation • Chord and web member section profiles are defined • Joist layout in coordination with metal deck fasteners would be confirmed • Non-standard joist seat depths and/or sloping joist seat 	 <p><i>32 B1010.10-LOD-350 Floor Structural Frame (Steel Joists)</i></p>

400

Element modeling to include:

- Welds
- Connection plates
- Member fabrication part number
- Quantity
- Spacing
- Anchorage
- Material required for proper installation
- Mark identification that correlates with bill of material
- Type of shop paint if required

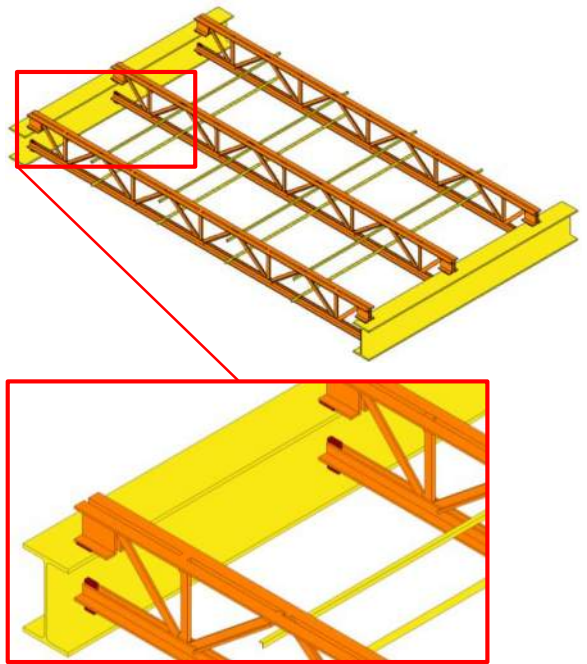

33 B1010.10-LOD-400 Floor Structural Frame (Steel Joists)

B1010.10 – Floor Structural Frame (Cold-Formed Metal Framing)

100	See B10	
200	Element modeling to include: <ul style="list-style-type: none">• Rough architectural masses• Approximate member depth• Desired member spacing	
300	Element modeling to include: <ul style="list-style-type: none">• floor element with design-specified locations and geometries Required non-graphic information associated with model elements includes: <ul style="list-style-type: none">• Member size, depth, and material with sloping geometry• Spacing and end elevations• Design loads• Deflection criteria	
350	Element modeling to include: <ul style="list-style-type: none">• Members modeled at any interface with wall edges (top, bottom, sides) or opening through wall• Bridging or straps	
400	Element modeling to include: <ul style="list-style-type: none">• Welds• Connections• Member fabrication part number• Any part required for complete installation	

B1010.10 – Floor Structural Frame (Masonry Framing)

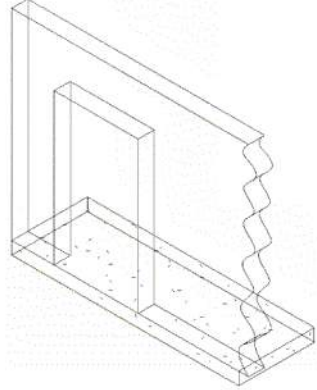
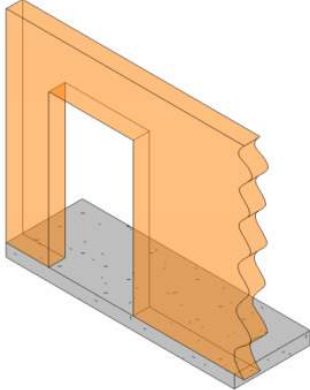
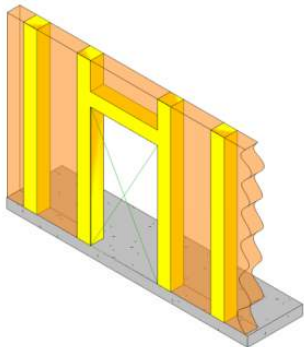
100	See B10	
200	See B10	 <p data-bbox="980 722 1471 777"><i>34 B1010.10-LOD-200 Floor Structural Frame (Masonry Framing)</i></p>
300	<p>Element modeling to include:</p> <ul style="list-style-type: none"> • floor element with design-specified locations and geometries <p>Required non-graphic information associated with model elements includes:</p> <ul style="list-style-type: none"> • Member size, depth, and material with sloping geometry • Spacing and end elevations • Design loads • Deflection criteria 	 <p data-bbox="980 1264 1471 1318"><i>35 B1010.10-LOD-300 Floor Structural Frame (Masonry Framing)</i></p>
350	<p>Element modeling to include:</p> <ul style="list-style-type: none"> • Members modeled at any interface with wall edges (top, bottom, sides) or opening through wall • Any regions that would impact coordination with other systems such as but not limited to: <ul style="list-style-type: none"> ○ Bond Beam & Lintel Regions ○ Reinforcing & Embed Regions ○ Jam Regions 	 <p data-bbox="980 1726 1471 1780"><i>36 B1010.10-LOD-350 Floor Structural Frame (Masonry Framing)</i></p>

400

Element modeling to include:

- Reinforcing
- Connections
- Grouting Material
- Jams
- Bond Beams
- Lintels
- Member fabrication part number
- Any part required for complete installation

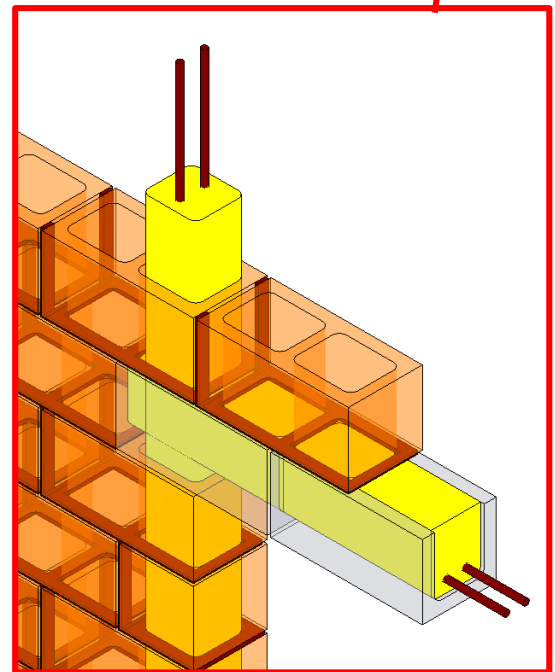
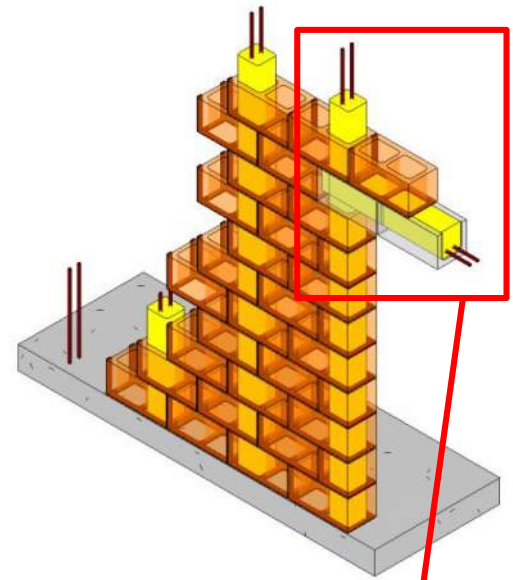

37 B1010.10-LOD-400 Floor Structural Frame
(Masonry Framing)

B1010.10 – Floor Structural Frame (Wood Floor Trusses)

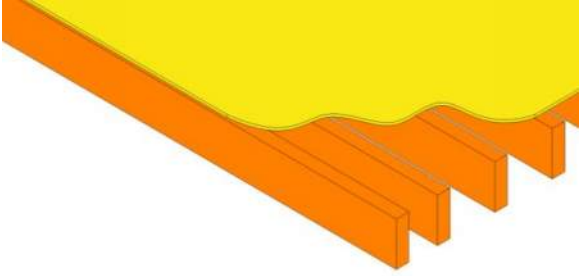
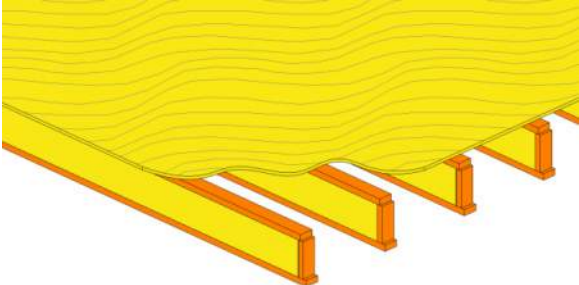
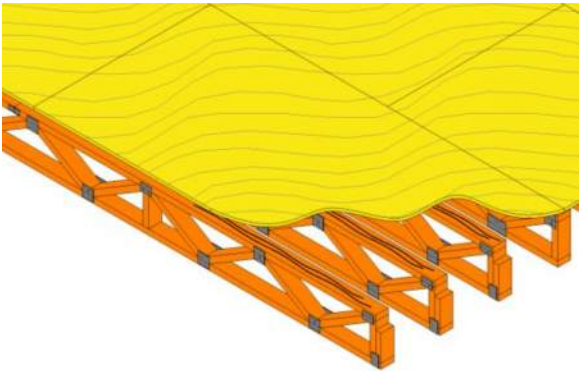
100	See B10	
200	<p>Element modeling to include:</p> <ul style="list-style-type: none"> • Approximate depth • Top chord or bottom chord bearing • Truss orientation • Approximate depth • Approximate width • Truss orientation • Approximate centerline location of individual trusses 	 <p><i>38 B1010.10-LOD-200 Floor Structural Frame (Wood Floor Trusses)</i></p>
300	<p>Element modeling to include:</p> <ul style="list-style-type: none"> • Truss size, depth, and material with sloping geometry • Spacing and end elevations • Support locations <p>Required non-graphic information associated with model elements includes:</p> <ul style="list-style-type: none"> • Member designation, load capacity and deflection criteria • Design loads 	 <p><i>39 B1010.10-LOD-300 Floor Structural Frame (Wood Floor Trusses)</i></p>
350	<p>Element modeling to include:</p> <ul style="list-style-type: none"> • Actual final truss profile with accurate panel points • Bridging and lateral braces • Fire protection coating • Any miscellaneous framing pertaining the truss • Erection details for installation • Chord and web member section profiles are accurately defined • Truss layout in coordination with deck fasteners would be confirmed • Hold down locations for large bolts. 	 <p><i>40 B1010.10-LOD-350 Floor Structural Frame (Wood Floor Trusses)</i></p>

400

Element modeling to include:

- Fasteners
- Sealant
- Truss plates and connection material
- Nails and fasteners
- Truss plates.
- Deck patterns and joints

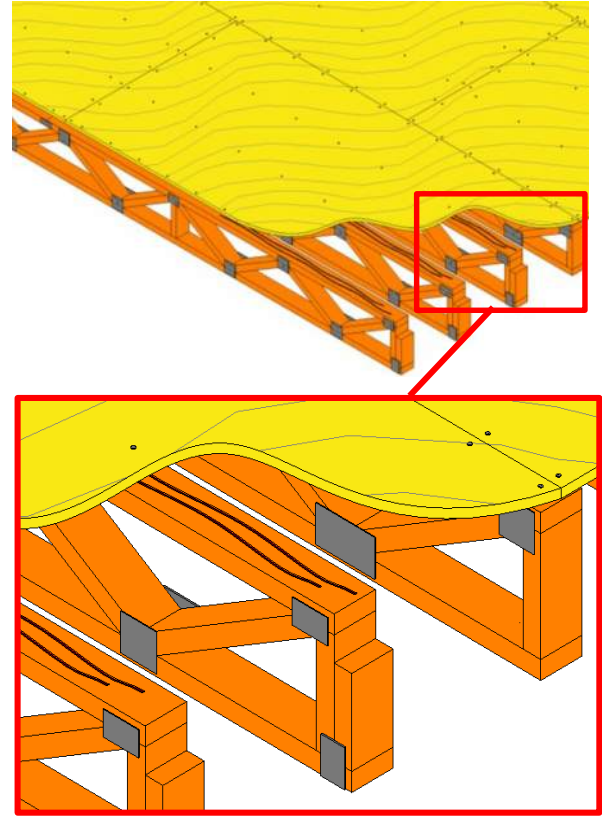

41 B1010.10-LOD-400 Floor Structural Frame (Wood Floor Trusses)

B1010.20 – Floor Decks, Slabs, and Toppings

Description: Structural slab, deck, and sheathing floor construction at intermediate floors of basement construction and above grade. Includes cast-in-place concrete, precast concrete, cementitious decks and toppings, metal decking, wood sheathing, and wood decking. Includes framed and sleeved penetrations for services and housekeeping pads for equipment. Includes Floor Construction Supplementary Components as appropriate.

Specific structural systems within this section are listed as follows:

- [Wood Floor Deck](#)
- [Metal Floor Deck](#)
- [Composite Floor Deck](#)
- [Concrete](#)

B1010.20 – Floor Decks, Slabs, and Toppings (Wood Floor Deck)

100	See B10	
200	See B10	
300	<p>Element modeling to include:</p> <ul style="list-style-type: none"> • Applicable slopes • Expected framing member profiles, spacing, and material <p>Required non-graphic information associated with model elements includes:</p> <ul style="list-style-type: none"> • Deck orientation • Deck material layer thicknesses • Diaphragm load and deflection criteria • Deck Material • Deck fasteners 	
350	<p>Element modeling to include:</p> <ul style="list-style-type: none"> • Deck edge location • Actual framing member and location per manufacture • All miscellaneous framing including braces, kickers, etc. • Deck openings modeled with support framing around openings • Point load locations • Actual opening locations and sizes defined 	
400	<p>Element modeling to include:</p> <ul style="list-style-type: none"> • All framing accessory and fasteners modeled per expected installation • Waterproofing 	

B1010.20 – Floor Decks, Slabs, and Toppings (Metal Floor Deck)

100	See B10	
200	See B10	
300	<p>Element modeling to include:</p> <ul style="list-style-type: none"> • Deck thickness • Specific Framing member profiles, spacing, and material • Opening locations are prescriptively defined with notes for additional miscellaneous framing • Point load locations <p>Required non-graphic information associated with model elements includes:</p> <ul style="list-style-type: none"> • Diaphragm load and deflection criteria • Deck material • Deck fasteners • Typical weld specifications 	
350	<p>Element modeling to include:</p> <ul style="list-style-type: none"> • Deck edge location • Deck splice and end lap locations • Actual deck profile and flute locations per manufacturer • All miscellaneous framing including braces, kickers, etc. • Deck openings modeled with support framing 	
400	<p>Element modeling to include:</p> <ul style="list-style-type: none"> • All framing accessory and fasteners modeled per expected installation • Welds • Waterproofing 	

B1010.20 – Floor Decks, Slabs, and Toppings (Composite Floor Deck)

100	See B10	
200	See B10	
300	<p>Element modeling to include:</p> <ul style="list-style-type: none"> • Specific deck thickness • Specific Framing member profiles, spacing, material • Opening locations are prescriptively defined with notes for additional miscellaneous framing <p>Required non-graphic information associated with model elements includes:</p> <ul style="list-style-type: none"> • Specific deck material • Deck fasteners • Typical weld specifications • Camber • Shear studs • Toppings 	
350	<p>Element modeling to include:</p> <ul style="list-style-type: none"> • Deck edge location • Actual deck profile and flute locations per manufacture • Deck splice and end lap locations • Actual framing member and location per manufacture • All miscellaneous framing including deck support, deck closure, shear studs, etc. • Slab openings modeled with support framing around openings • Point load locations • Slab reinforcing modeled if specified in BIMXP 	
400	<p>Element modeling to include:</p> <ul style="list-style-type: none"> • All framing accessory and fasteners modeled per expected installation • All slab reinforcing • Welds • Waterproofing 	

B1010.20 – Floor Decks, Slabs, and Toppings (Concrete)

100	See B10	
200	<p>Element modeling to include:</p> <ul style="list-style-type: none"> • Type of structural concrete system • Approximate geometry (e.g. depth) of structural elements 	
300	<p>Element modeling to include:</p> <ul style="list-style-type: none"> • Specific sizes and locations of main concrete structural members modeled per defined structural grid with correct orientation • All sloping surfaces included in model element with exception of elements affected by manufacturer selection <p>Required non-graphic information associated with model elements includes:</p> <ul style="list-style-type: none"> • Concrete strength, • Reinforcing strength • Air entrainment, • Aggregate size • Typical details 	
350	<p>Element modeling to include:</p> <ul style="list-style-type: none"> • Reinforcement called out, modeled if required by the BIMXP, typically only in congested areas • Pour joints and sequences to help identify reinforcing lap splice locations, scheduling, etc. • Expansion Joints • Embeds and anchor rods • Post-tension profile and strands modeled if required by the BIMXP • Penetrations for items such as MEP • Any permanent forming or shoring components • Shear reinforcing and stud rails <p>Required non-graphic information associated with model elements includes:</p> <ul style="list-style-type: none"> • Embeds and anchor rods • Aggregate, clear cover • Reinforcing spacing • Reinforcing • Live loads • Shear reinforcing and stud rails • Reinforcing post-tension profiles and strand locations • Penetrations for items such as MEP • Finishes, camber, chamfers, etc. 	
400	<p>Element modeling to include:</p> <ul style="list-style-type: none"> • All reinforcement including post tension elements detailed and modeled • Finishes, camber, chamfer, etc. 	

B1020 – Roof Construction

[See [B1010](#)]

B1020.10 – Roof Structural Frame

Description: Structural elements required for support of floor construction within basements and above grade. Includes columns, girders, beams, trusses, joists. Includes cast-in-place concrete, precast concrete, unit masonry, metal framed, and wood framed systems. Includes framed and sleeved openings for services. Includes Floor Construction Supplementary Components as appropriate.

[See [B1010.10](#)]

B1020.20 – Roof Decks, Slabs, and Sheathing

Includes: Structural roof deck, slab, and sheathing construction. Includes cast-in-place concrete, precast concrete, cementitious decks and toppings, metal decking, wood sheathing, wood decking, timber decking and expansion control. Includes framed and sleeved penetrations for services and housekeeping pads for equipment. Includes Roof Construction Supplementary Components as appropriate.

[See [B1010.20](#)]

B1020.30 – Canopy Construction

Includes: Structural frame and decks, slabs, and sheathing for canopy construction.

These components are typically modeled as part of other assemblies listed in the tables above. Do not assign this Unifomat classification unless a supplementary component is modeled independently of another assembly.

[See [B1010.20](#)]

B1080 – Stairs

100	Assumptions for all stair systems (including railings, fire escapes, walkways, and ladders) are included in other modeled elements such as a spatial or massing element; or, schematic model element that indicates the approximate overall dimensions of the stair layout.	
-----	---	--

B1080.10 – Stair Construction

Includes: Structural framing for exterior and interior stairs including treads, risers, and landings. Includes fire escapes and ladders.

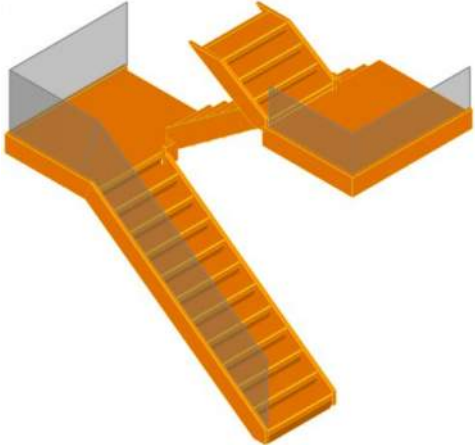
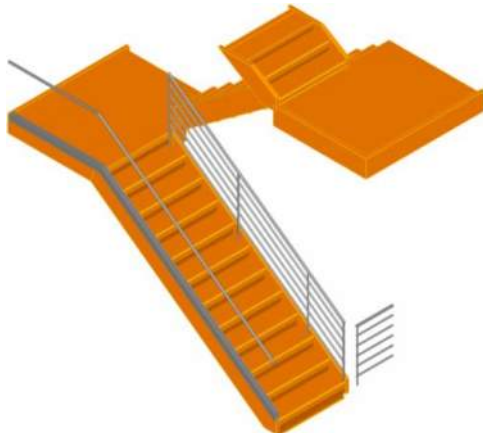
100	See B1080	
200	<p>Generic model element with simplified treads and risers.</p> <p>Nominal overall unit scope shall include:</p> <ul style="list-style-type: none"> • Nominal plan dimensions (length, width) • Nominal vertical dimensions (levels, landings) 	 <p>42 B1080.10-LOD-200 Stair Construction</p>
300	<p>Major stair support elements are modeled (stringers).</p> <p>Treads and risers are modeled to indicate design-specified nosing conditions.</p>	 <p>43 B1080.10-LOD-300 Stair Construction</p>

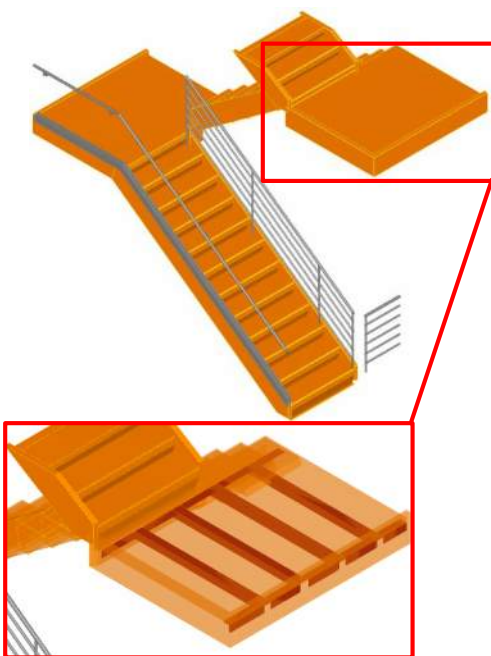
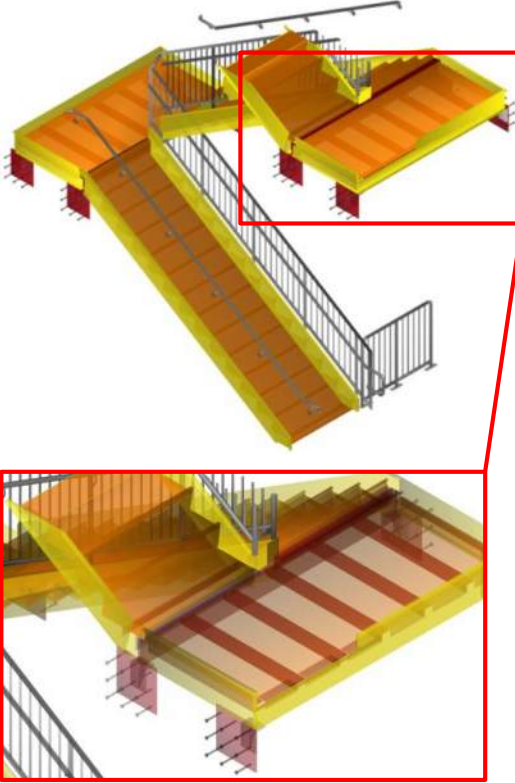
<p>350</p>	<p>Secondary stair support elements are modeled (hangers, brackets, etc.). Required clearance/code zones are modeled.</p>	 <p>44 B1080.10-LOD-350 Stair Construction</p>
<p>400</p>	<p>All stair elements are modeled to support fabrication and installation.</p>	 <p>45 B1080.10-LOD-400 Stair Construction</p>

B1080.50 – Stair Railings

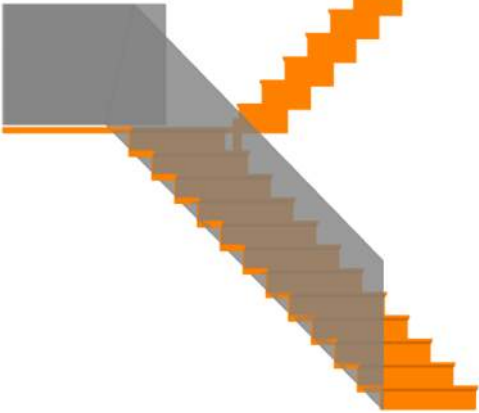
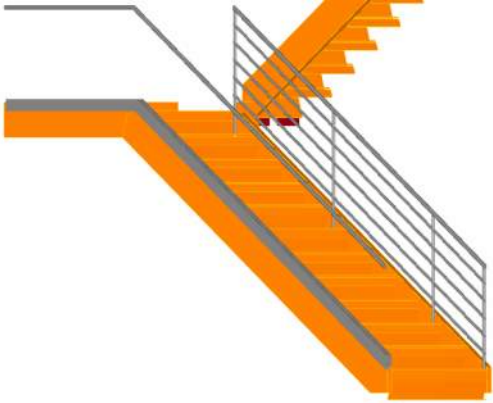
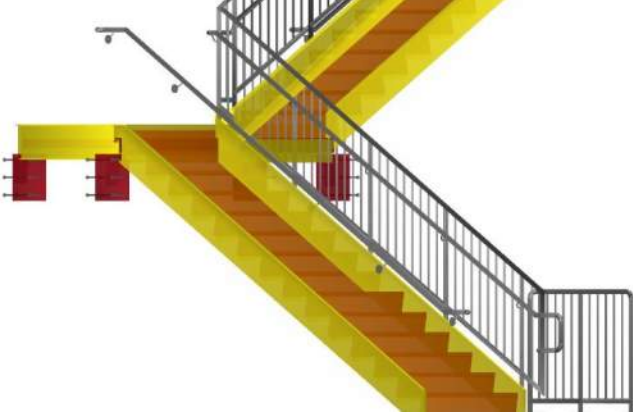
100	See B1080	
200	Generic model elements without articulation of material or railing structure such as balusters, posts, or supports.	 <p>46 B1080.50-LOD-200 Stair Railings</p>
300	<p>Modeled assemblies by type to include:</p> <ul style="list-style-type: none"> • Railings • Balusters • Posts • Supports for wall mounted railings <p>Required non-graphic information associated with model element includes:</p> <ul style="list-style-type: none"> • Material 	 <p>47 B1080.50-LOD-300 Stair Railings</p>
400	[See Fundamental LOD Definitions]	 <p>48 B1080.50-LOD-400 Stair Railings</p>

B1080.60 – Fire Escapes

[See [B1080.10](#) and [B1080.50](#)]

B1080.70 – Metal Walkways
[See [B1080.10](#) and [B1080.50](#)]

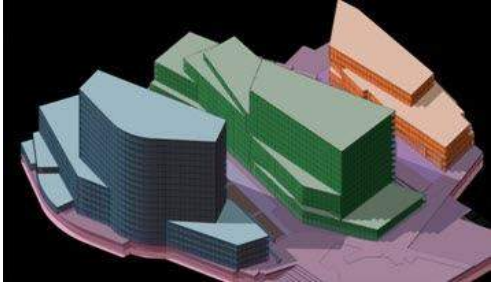

B1080.80 – Ladders
[See [B1080.10](#) and [B1080.50](#)]

B20 Exterior Vertical Enclosures

<p>100</p>	<p>Solid mass model representing overall building volume; or, schematic wall elements that are not distinguishable by type or material.</p> <p>Assembly depth/thickness and locations still flexible.</p>	
------------	---	---

B2010 – Exterior Walls

Solid wall construction that is composite in nature; in other words, multiple layers of materials to form an overall assembly.

<p>100</p>	<p>See B20</p>	
<p>200</p>	<p>Generic wall objects separated by type of material (e.g. brick wall vs. terracotta).</p> <p>Approximate overall wall thickness represented by a single assembly.</p> <p>Layouts and locations still flexible.</p>	 <p><i>49 B2010-LOD-200 Exterior Walls</i></p>
<p>300</p>	<p>Composite model assembly with specific overall thickness that accounts for veneer, structure, insulation, air space, and interior skin specified for the wall system. (Refer to LOD350 and LOD400 for individually modeled elements)</p> <p>Penetrations are modeled to nominal dimensions for major wall openings such as windows, doors, and large mechanical elements.</p> <p>Required non-graphic information associated with model elements includes:</p> <ul style="list-style-type: none"> • Wall type • Materials 	 <p><i>50 B2010-LOD-300 Exterior Walls</i></p>
<p>350</p>	<p>A composite wall assembly may be considered for LOD350 only if hosted objects such as windows and doors are provided at a minimum of LOD350.</p> <p>Main structural members such as headers and jambs at openings are modeled within the composite assembly.</p>	 <p><i>51 B2010-LOD-350 Exterior Walls</i></p>

B2010 – Exterior Wall (Masonry)

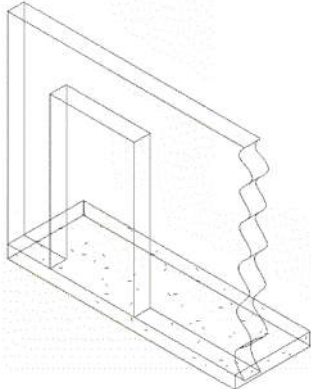
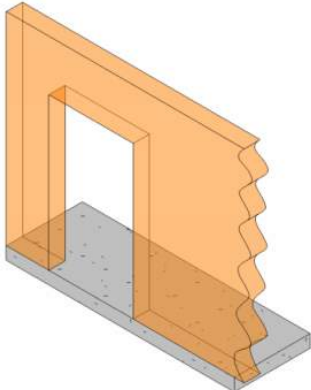
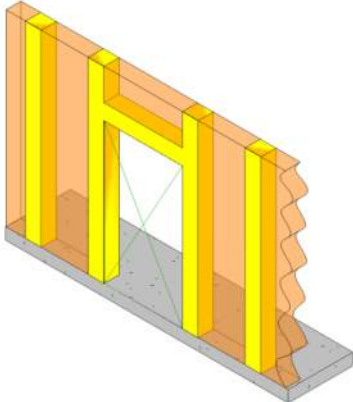
100	See B10	
200	See B2010	 <p data-bbox="980 716 1479 747"><i>52 B2010.04-LOD-200 Exterior Wall (Masonry)</i></p>
300	<p>Element modeling to include:</p> <ul style="list-style-type: none"> • Element with design-specified locations and geometries <p>Required non-graphic information associated with model elements includes:</p> <ul style="list-style-type: none"> • Member size, depth, and material with sloping geometry • Spacing and end elevations • Design loads • Deflection criteria 	 <p data-bbox="980 1224 1479 1255"><i>53 B2010.04-LOD-300 Exterior Wall (Masonry)</i></p>
350	<p>Element modeling to include:</p> <ul style="list-style-type: none"> • Members modeled at any interface with wall edges (top, bottom, sides) or opening through wall • Any regions that would impact coordination with other systems such as but not limited to: <ul style="list-style-type: none"> ○ Bond Beam & Lintel Regions ○ Reinforcing & Embed Regions ○ Jam Regions 	 <p data-bbox="980 1722 1479 1753"><i>54 B2010.04-LOD-350 Exterior Wall (Masonry)</i></p>

400

Element modeling to include:

- Reinforcing
- Connections
- Grouting Material
- Jams
- Bond Beams
- Lintels
- Member fabrication part number
- Any part required for complete installation

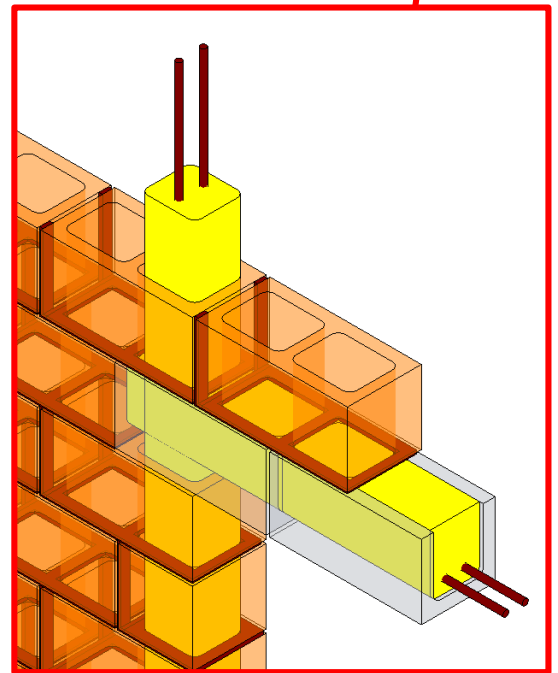
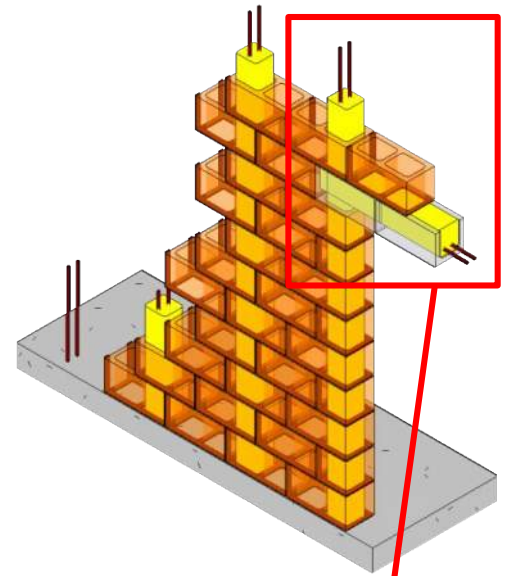

55 B2010.04-LOD-400 Exterior Wall (Masonry)

B2010 – Exterior Wall (Cold-Form Metal Framing)

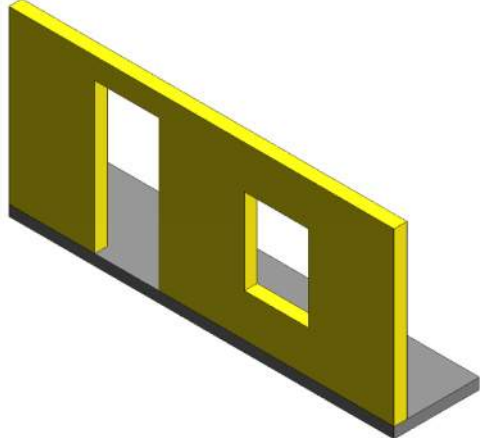
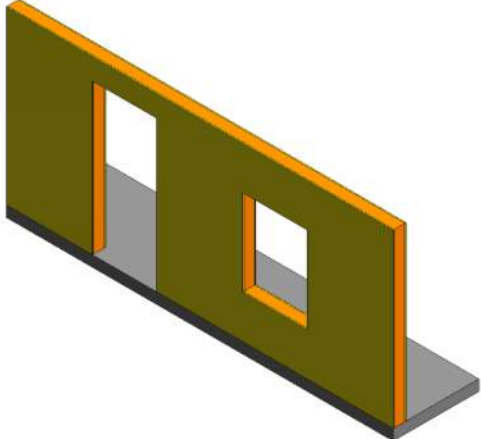
100	See B20	
200	See B2010	 <p data-bbox="915 716 1430 768"><i>56 B2010.05-LOD-200 Exterior Wall (Cold-Form Metal Framing)</i></p>
300	See B2010	 <p data-bbox="915 1304 1430 1356"><i>57 B2010.05-LOD-300 Exterior Wall (Cold-Form Metal Framing)</i></p>

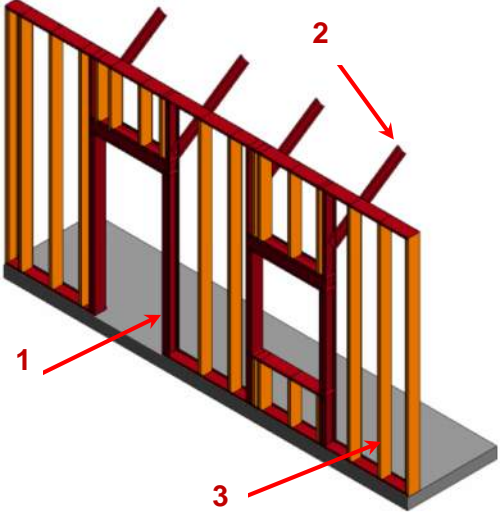
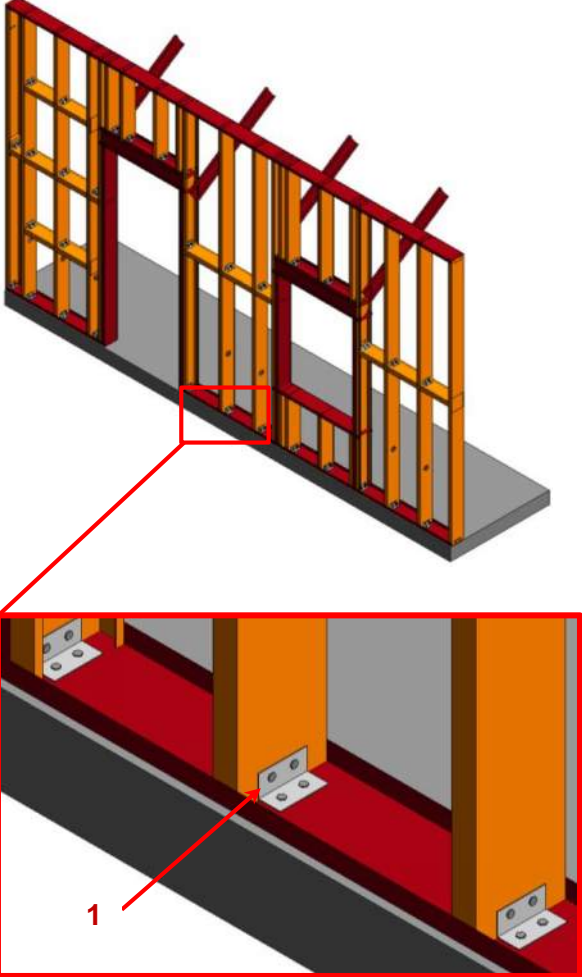
<p>350</p> <p>Cold formed metal framing is developed with sufficient elements to support detailed interface coordination with other systems such as MEP.</p> <p><i>Image notes:</i></p> <ol style="list-style-type: none"> 1) Elements in red are critical wall support elements that cannot be easily cut for coordination of MEP opening through the walls. 2) Diagonal bracing (kickers) that may be in the above ceiling space are modeled for coordination with other building content such as MEP passing along the wall in the above ceiling spaces. 3) Infill cold formed metal framing modeling (Orange) may be omitted at this LOD if stated in the BXP. 4) Cladding and sheathing are not shown for clarity in this image. 		 <p>58 B2010.05-LOD-350 Exterior Wall (Cold-Form Metal Framing)</p>
<p>400</p> <p>Cold formed metal framing is developed with sufficient elements that support the fabrication of the CFMF system.</p> <p><i>Image notes:</i></p> <ol style="list-style-type: none"> 1) Connection content is development in the wall elements. This includes but is not limited to fasteners, clips, and other related hardware. 2) Cladding and sheathing are not shown for clarity in this image. 		 <p>59 B2010.05-LOD-400 Exterior Wall (Cold-Form Metal Framing)</p>

B2010 – Exterior Wall (Wood)

100	See B20	
200	See B2010	 <p data-bbox="915 743 1386 772"><i>60 B2010.06-LOD-200 Exterior Wall (Wood)</i></p>
300	See B2010	 <p data-bbox="924 1320 1395 1350"><i>61 B2010.06-LOD-300 Exterior Wall (Wood)</i></p>

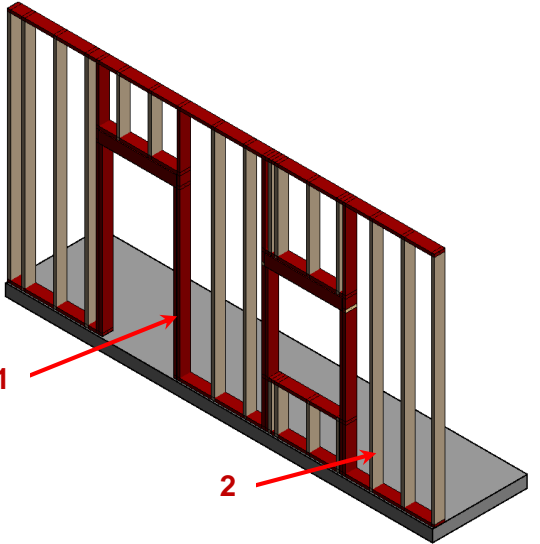
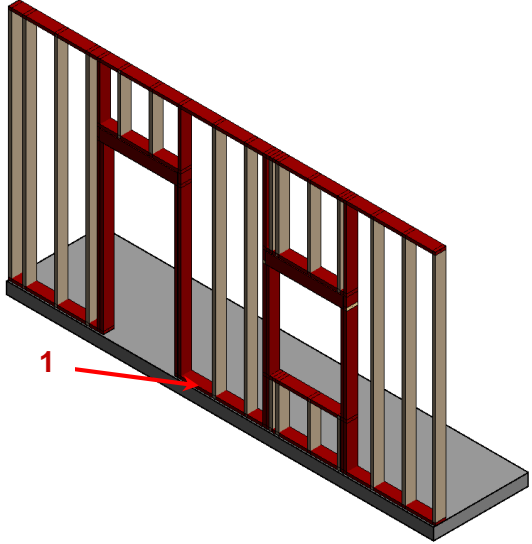
<p>350</p>	<p>Wood framing is developed with sufficient elements to support detailed interface coordination with other systems such as MEP.</p> <p><i>Image notes:</i></p> <ol style="list-style-type: none">1) Elements in red are critical wall support elements that cannot be easily cut for coordination of MEP opening through the walls.2) Infill wood framing modeling may be omitted at this LOD if stated in the BXP.3) Cladding and sheathing are not shown for clarity in this image.	 <p>62 B2010.06-LOD-350 Exterior Wall (Wood)</p>
<p>400</p>	<p>Wood framing is developed with sufficient elements that support the fabrication of the wood framing system.</p> <p><i>Image notes:</i></p> <ol style="list-style-type: none">1) Connection content is development in the wall elements. This includes but is not limited to fasteners, anchor rods, and other related hardware.2) Cladding and sheathing are not shown for clarity in this image.	 <p>63 B2010.06-LOD-400 Exterior Wall (Wood)</p>

B2010.10 – Exterior Wall Veneer

Description: Nonstructural outside face elements of exterior walls. Includes precast concrete, unit masonry, EIFS, manufactured siding, and stucco.

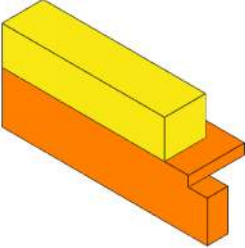
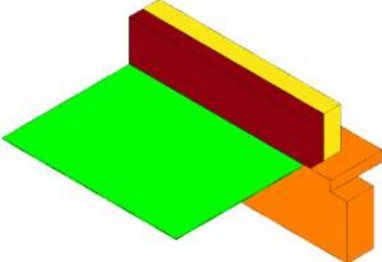
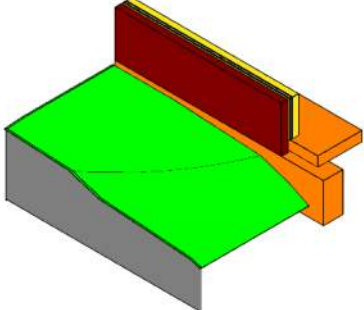
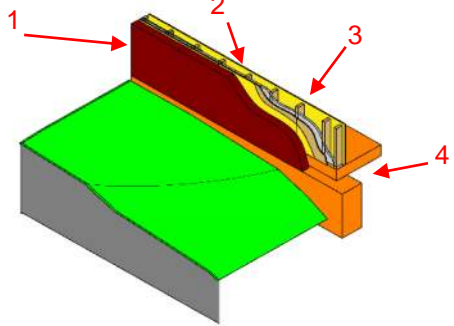
100	See B20	 <p>64 B2010.10-LOD-100 Exterior Wall Veneer</p>
200	See B2010	 <p>65 B2010.10-LOD-200 Exterior Wall Veneer</p>
300	See B2010	 <p>66 B2010.10-LOD-300 Exterior Wall Veneer</p>
350	<p>Exterior wall veneer modeled as a separate element. All openings modeled to rough dimensions. Precast concrete panels are individually modeled. Connection points are specified.</p> <p><i>Images notes:</i></p> <ol style="list-style-type: none"> 1) Wall veneer element 2) Skin layers 3) Core framing 4) Concrete slab edge 	 <p>67 B2010.10-LOD-350 Exterior Wall Veneer</p>

400

Element modeling includes:

Image notes:

- 1) *Individual masonry units*
- 2) *Skin layers including*
- 3) *Moisture barrier, sheathing, and insulation*
- 4) *Core framing*
- 5) *Bolt*
- 6) *Concrete slab edge*
- 7) *Weep holes*

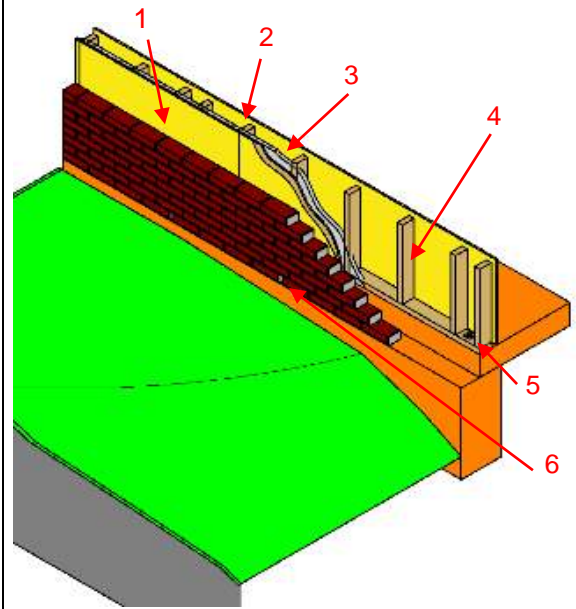

68 B2010.10-LOD-400 Exterior Wall Veneer

B2010.20 – Exterior Wall Construction

Description: Exterior wall construction including backup systems for wall veneer. May be vertical load bearing. Includes cast-in-place concrete walls, precast concrete walls, unit masonry walls, metal framed wall systems, and wood framed wall systems.

100	See B20	
200	See B2010	
300	See B2010	
350	Exterior wall construction modeled as a separate element. All openings modeled to rough dimensions. Headers and jamb framing are modeled.	 <p>69 B2010.20-LOD-350 Exterior Wall Construction</p>
400	Element modeling to include: <ul style="list-style-type: none"> • Studs and tracks • Individual masonry units • Reinforcing • Sheathing • Insulation 	

B2010.30 – Exterior Wall Interior Skin

Description: Materials to provide finish or protective covering on inside of face of exterior walls. May include insulation and vapor retarder.

100	See B20	
200	See B2010	
300	See B2010	
350	Exterior wall interior skin modeled as a separate element. All openings modeled to rough dimensions.	 <p>70 B2010.30-LOD-350 Exterior Wall Interior Skin</p>
400	Element modeling to include: <ul style="list-style-type: none"> • Studs and tracks • Individual masonry units • Reinforcing • Wall board • Insulation 	

B2010.50 – Parapets

Exterior wall construction above plane of roof.

[See [B2010](#), [B2010.10](#), [B2010.20](#), and [B2010.30](#)]

B2010.60 – Equipment Screens

Exterior wall construction to screen equipment from public view.

[See [B2010](#), [B2010.10](#), [B2010.20](#), and [B2010.30](#)]

B2020 – Exterior Windows

100	See B20	
200	Windows approximate in terms of location, size, count and type. Units are modeled as a simple, monolithic component; or represented with simple frame and glazing. Nominal unit size is provided.	

B2020.10 – Exterior Operating Windows

100	See B20	
200	See B2020	
300	Units are modeled based on specified location and nominal size. Outer geometry of window frame elements and glazing modeled. Operation is indicated. Required non-graphic information associated with model elements includes: <ul style="list-style-type: none"> • Aesthetic characteristics (finishes, glass types) • Performance characteristics (i.e. U-value, wind loading, blast resistance, structural, air, thermal, water, sound) • Functionality of the window (fixed, casement, double/single hung, awning/project out, pivot, sliding) 	
350	Rough opening dimensions Attachment method of window to structure Embed geometry	
400	Frame profiles Glazing sub-components (gaskets) Attachment components	

B2020.20 – Exterior Fixed Windows

[See [B2020.10](#)]

B2020.30 – Exterior Window Wall

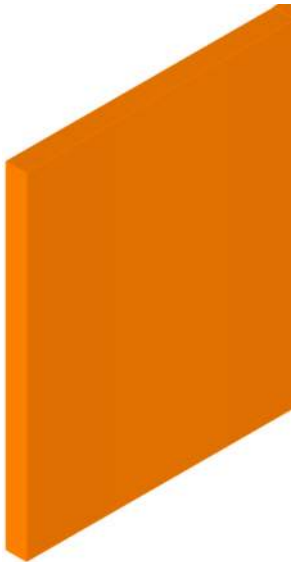
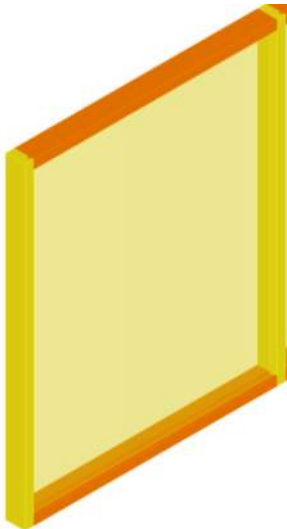
100	See B20	
200	<p>Generic wall objects representing major types of proposed window wall assemblies.</p> <p>Overall window wall assembly depth represented by a single model object.</p> <p>Layouts and locations still flexible.</p>	 <p data-bbox="764 913 1240 940"><i>71 B2020.30-LOD-200 Exterior Window Wall</i></p>
300	<p>Specified location and orientation of face of glass.</p> <p>Nominal face dimensions and thickness of glazing.</p> <p>Structural support systems of wall to be modeled.</p> <p>Spacing, location, size and orientation of mullions.</p> <p>Operable components defined (windows, louvers and doors) and included in model.</p>	 <p data-bbox="764 1528 1240 1556"><i>72 B2020.30-LOD-300 Exterior Window Wall</i></p>

350

Mullion shapes and geometry defined.
Actual anchorage layouts and types defined.
Actual panel dimensions (including seating).

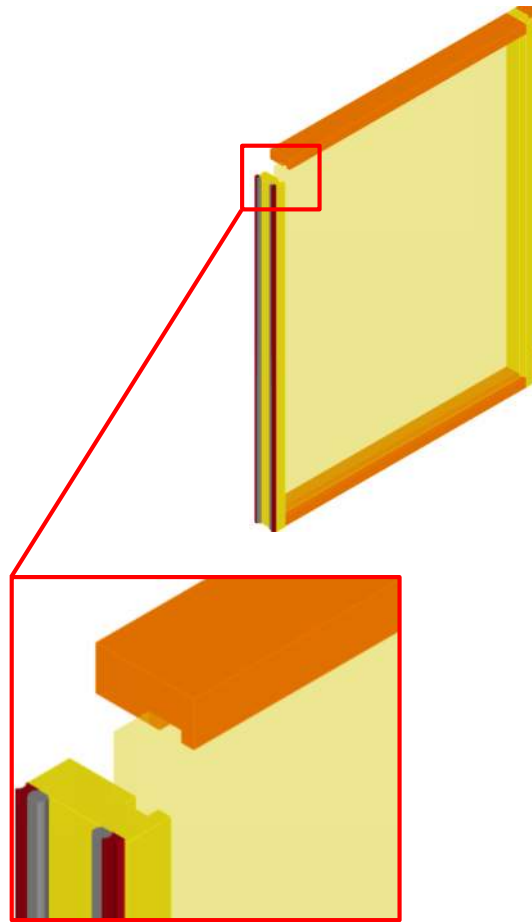

73 B2020.30-LOD-350 Exterior Window Wall

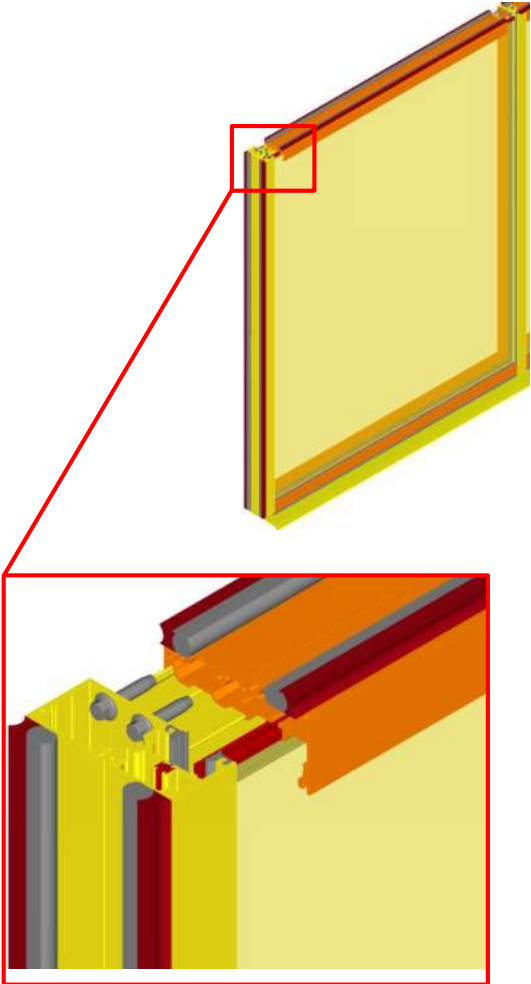
<p>400</p>	<p>Complete mullion extrusion profiles. Interface details between wall systems (within) and wall and support systems including sealants, end dams, flashings and membranes.</p>	 <p>74 B2020.30-LOD-400 Exterior Window Wall</p>
------------	---	---

B2020.50 – Exterior Special Function Windows

[See [B2020.10](#)]

B2050 – Exterior Doors and Grilles

<p>100</p>	<p>Simple representation of a door unit. Size, count, and location are approximate.</p>	
<p>200</p>	<p>Units are modeled as a simple, monolithic component; or represented with simple frame and panel. Nominal unit size is provided.</p>	

B2050.10 – Exterior Entrance Doors

Exterior personnel door assemblies at main entrances. Includes automatic, revolving, balanced, and other special operating entrance doors, and sliding storefront wall systems.

100	See B20	
200	See B2050	
300	<p>Entrance door assemblies modeled by type to include the following:</p> <p>Specific door panels and frames (if applicable).</p> <p>Hardware set functionality and types are specified in non-graphic information.</p> <p>Operation is specified .Spatial requirements for operation are modeled.</p>	
350	<p>Rough opening is modeled (if applicable).</p> <p>Major framing elements are modeled at jambs and head.</p> <p>Operation or mechanism enclosures are modeled.</p>	
400	<p>Actual frame/mullion extrusions.</p> <p>Actual panel size dimensions.</p> <p>All connections and interfaces modeled including brackets, supports, sealants, and thresholds.</p>	

B2050.20 – Exterior Utility Doors

Exterior personnel door assemblies other than at main entrances.

100	See B20	
200	See B2050	
300	<p>Entrance door assemblies modeled by type to include the following:</p> <p>Specific door panels and frames (if applicable).</p> <p>Hardware set functionality and types are specified in non-graphic information.</p> <p>Operation is specified graphicly and with non-graphic information.</p> <p>Spatial requirements for operation are provided.</p>	
350	<p>Rough opening is modeled</p> <p>Major framing elements are modeled at jambs and head</p>	
400	All connections and interfaces modeled including brackets, supports, sealants, and thresholds.	

B2050.30 – Exterior Oversize Doors

Large exterior door assemblies to allow for passage of large objects involving various operating methods.

100	See B20	
200	See B2050	
300	Oversize door assemblies modeled by type to include the following: Door panels with nominal dimensions. Frames with nominal dimensions. Hardware set functionality and types included in non-graphic information. Clearance zones are modeled for operation of overhead doors. Enclosures and motor housings are modeled with overall nominal dimensions.	
350	Rough opening is modeled (if applicable). Major framing elements in wall are modeled at jambs and head. Other major structural support elements are modeled such as support posts and beams.	
400	All connections and interfaces modeled including brackets, supports, sealants, and thresholds.	

B2050.40 – Exterior Special Function Doors

[See [B2050.20](#) or [B2050.30](#)]

B2050.60 – Exterior Grilles

Exterior devices of open construction to provide moveable barrier to provide access through wall or other divider.

100	See B20	
200	See B2050	
300	Grille assemblies modeled by type to include the following: Nominal size of unit. Required openness provided as non-graphic information. Operation is specified.	
350	Rough opening is modeled (if applicable). Major framing elements are modeled at jambs and head.	
400	All connections and interfaces modeled including brackets, supports, sealants, and thresholds.	

B2050.70 – Exterior Gates

Exterior devices of solid or open construction to provide moveable barrier to provide access through wall or other divider.

[See [B2050.60](#)]

B2050.90 – Exterior Door Supplementary Components

Includes frames, hardware, glazing and louvers that are part of door to be included with exterior door elements above as appropriate.

These components are typically modeled as part of other assemblies listed in the tables above. Do not assign this Unifomat classification unless a supplementary component is modeled independently of another assembly.

B2070 - Exterior Louvers and Vents

100	See B20	
200	Generic model element that is indicative of approximate area and location of intended louver/vent.	

B2070.10 – Exterior Louvers

100	See B20	
200	See B2070	
300	Louver assembly modeled by type, indicative of area and location of intended louver/vent. Includes accurate frame (boundary dimensions) and blades. Opening for louver is cut from host wall Performance level defined in non-graphic information associated with model elements (e.g. storm proof or not, free air)	
350	Rough opening is modeled (if applicable) Major framing elements are modeled at connection points. Connection points are modeled.	
400	All connections and interfaces modeled including brackets, supports, and sealants.	

B2070.50 – Exterior Vents

[See [B2070.10](#)]

B2080 - Exterior Wall Appurtenances

[See [B2050](#)]

B2080.10 – Exterior Fixed Grilles and Screens

Exterior enclosures, grilles and screens of wood, metal, plastic, and other materials for a variety of purposes including screening of equipment.

[See [B2050.60](#)]

B2080.30 – Exterior Opening Protection Devices

Manufactured items such as louvers, fins, shutters, demountable panels, awnings, and sun screens to provide sun control, privacy, security, insulation, and storm protection on exterior of windows, skylights, and entrances. Includes fixed and moveable, manually and electrically operated, and automatically controlled devices.

[See [B2010.60](#)]

B2080.50 – Exterior Balcony Walls and Railings

[See [B2010.50](#)]

B2080.70 – Exterior Fabrications

Fabrications of a variety of materials formed to various profiles for a variety of purposes including column covers, decorative metal, ornamental woodwork, and plaster fabrications.

[See [Fundamental LOD Definitions](#)]

B2080.80 – Bird Control Devices

[See [Fundamental LOD Definitions](#)]

B2090 – Exterior Wall Specialties

Complete fabrication of metal, wood, and fiberglass, including accessories and appurtenances. For example, clocks, below-grade egress assemblies, and window wells.

[See [Fundamental LOD Definitions](#)]

B30 Exterior Horizontal Enclosures

100	Solid mass model representing overall building volume; or, schematic wall elements that are not distinguishable by type or material. Assembly depth/thickness and locations still flexible.	
-----	--	--

B3010 – Roofing

100	See B30	
200	Generic assembly that contains spatial (layer) allowance for structural slab/deck and/or framing system.	
300	Individual substrate layers are not separately modeled, but they are specified within a composite assembly. Roof structure is modeled separately.	

B3010.10 – Steep Slope Roofing

Lapped roofing shingles, shakes and roofing tiles, including fastening and flashing products and methods.

[See [B1020](#)]

Steep slope roofing material is often modeled as a layer within the overall roof structure assembly.

B3010.50 – Low Slope Roofing

Includes membrane roofing of various types and protected membrane roofing, including fastening and flashing products.

100	See B30	
200	See B3010	
300	Specific material thickness, openings are subtracted from solid. Framing is a separate assembly, see B10 . Drainage pitches are modeled.	

B3010.70 – Canopy Roofing

[See [B3010.10](#) or [B3010.50](#)]

B3010.90 – Roofing Supplementary Components

Includes substrate boards, vapor retarder, air barriers, deck insulation, flashing and sheet metal, and expansion joints to be included with roofing elements above as appropriate.

These components are typically modeled as part of other assemblies listed in the tables above. Do not assign this Unifomat classification unless a supplementary component is modeled independently of another assembly.

B3020 – Roof Appurtenances

Roof specialties and accessories installed on or in roofing or traffic bearing horizontal enclosure systems. Includes components for the management of rainwater, but excludes mechanical and structural items.

100	See B30	
200	See Fundamental LOD Definitions	

B3020.10 – Roof Accessories

Includes ladders, curbs, vents, walkways, and snow guards.

100	See B30	
200	See Fundamental LOD Definitions	
300	<p><u>Ladders</u>: Specific assemblies indicating length and width.</p> <p><u>Walkways</u>: Specific assemblies indicating length, width, and rail/guard height.</p> <p><u>Vents</u>: Specific assemblies indicating roof opening size. Roof opening element is included.</p>	
350	<p><u>Ladders</u>: Specific assemblies indicating length, width, and attachment/anchoring members. Required access/clearance space is modeled.</p> <p><u>Walkways</u>: Specific assemblies indicating length, width, rail/guard height, and support/attachment/anchoring members. Required access/clearance space is modeled.</p> <p><u>Vents</u>: Specific assemblies indicating roof opening size and attachment/anchoring members if applicable. Required service access space is modeled.</p>	

B3020.30 – Roof Specialties

Includes cupolas, spires, steeples, and weathervanes.

[See [Fundamental LOD Definitions](#)]

B3020.70 – Rainwater Management

Includes conductor heads, gutters, downspouts, scuppers, and splash blocks.

[See [D2030.10](#) and [D2030.20](#)]

B3040 – Traffic Bearing Horizontal Enclosures

100	See B30	
200	Modeled as part of other composite assembly. See B3010 .	

B3040.10 –Traffic Bearing Coatings

Includes surface applied waterproofing exposed to weather and suitable for pedestrian or vehicular traffic.

[Not Modeled]

B3040.30 – Horizontal Waterproofing Membrane

Includes substrate board, deck insulation, vapor retarder, sheet metal flashing and trim, flexible flashing, and expansion joints.

100	See B30	
200	See B3040	
300	Membrane assembly modeled by type to specified thickness. Major openings such as shafts and hatches are modeled.	
350	Individual material layers of membrane assembly are modeled separately. All openings and penetrations are modeled. Expansion joints are modeled indicating specific width.	

B3040.50 – Wear Surfaces

Wearing surfaces on top of horizontal waterproofing membrane that are suitable for pedestrian or vehicular traffic.

100	See B30	
200	See B3040	
300	Wear surface system modeled by type to specified thickness/depth. Major openings such as shafts and hatches are modeled.	
350	Individual system elements are modeled separately. Pedestals are modeled and located properly, if applicable. Expansion joints are modeled indicating specific width.	

B3040.90 – Horizontal Enclosure Supplementary Components

Includes substrate board, deck insulation, vapor retarder, sheet metal flashing and trim, flexible flashing, and expansion joints to be included with horizontal enclosure elements above as appropriate.

These components are typically modeled as part of other assemblies listed in the tables above. Do not assign this Uniformat classification unless a supplementary component is modeled independently of another assembly.

B3060 – Horizontal Openings

100	See B30	
200	See B2020	

B3060.10 – Roof Windows and Skylights

[See [B2020.10](#)]

B3060.50 – Vents and Hatches

Other roof openings such as roof hatches, smoke vents, and gravity roof ventilators.

[See [B3020.10](#)]

B3060.90 – Horizontal Opening Supplementary Components

Includes: Frames, hardware, glazing, flashing, and joint sealants to be included with horizontal opening elements above as appropriate.

These components are typically modeled as part of other assemblies listed in the tables above. Do not assign this Unifomat classification unless a supplementary component is modeled independently of another assembly.

B3080 – Overhead Exterior Enclosures

100	See B30	
200	Generic assemblies indicative of overall scope and approximate thickness/system depth of overhead enclosure.	

B3080.10 – Exterior Ceilings

100	See B30	
200	See B3080	
300	Overall assembly modeled to specific system thickness including structural backing. Location of expansion or control joints indicated, but not modeled.	
350	Face material modeled to specific thickness. Structural backing members including bracing/lateral framing/kickers are modeled. Expansion or control joints are modeled to indicate specific width.	
400	Individual elements of face material are modeled. Structural backing members and all support members (kickers) are modeled including all connections. Expansion or control joints are modeled.	

B3080.20 – Exterior Soffits

[See [B3080.10](#)]

B3080.30 – Exterior Bulkheads

[See [B3080.10](#)]

C: INTERIORS

C10 Interior Construction

100	A schematic model element or symbol that is not distinguishable by type or material. Types, layouts, and locations are still flexible.	
-----	---	--

C1010 – Interior Partitions

100	See C10	
200	Generic wall objects separated by type of material (e.g. gypsum board vs. masonry). Approximate overall wall thickness represented by a single assembly. Layouts, locations, heights, and elevation profiles are still flexible.	

C1010 – Interior Wall (Masonry)

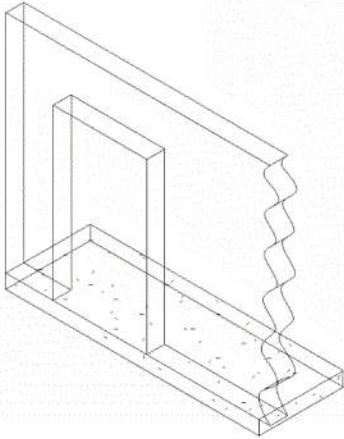
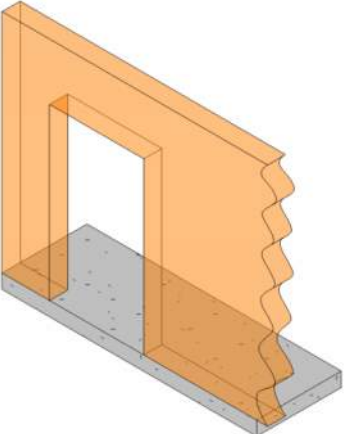
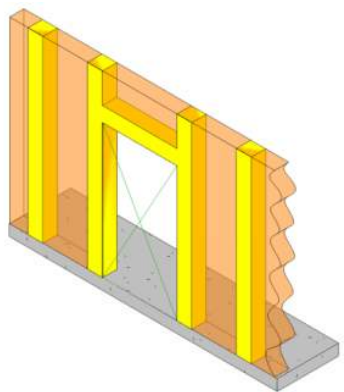
100	See C10	
200	See C1010	 <p data-bbox="982 730 1469 756"><i>75 C1010.04-LOD-200 Interior Wall (Masonry)</i></p>
300	<p>Element modeling to include:</p> <ul style="list-style-type: none"> • floor element with design-specified locations and geometries <p>Required non-graphic information associated with model elements includes:</p> <ul style="list-style-type: none"> • Member size, depth, and material with sloping geometry • Spacing and end elevations • Design loads • Deflection criteria 	 <p data-bbox="982 1260 1469 1285"><i>76 C1010.04-LOD-300 Interior Wall (Masonry)</i></p>
350	<p>Element modeling to include:</p> <ul style="list-style-type: none"> • Members modeled at any interface with wall edges (top, bottom, sides) or opening through wall • Any regions that would impact coordination with other systems such as but not limited to: <ul style="list-style-type: none"> ○ Bond Beam & Lintel Regions ○ Reinforcing & Embed Regions ○ Jam Regions 	 <p data-bbox="982 1753 1469 1778"><i>77 C1010.04-LOD-350 Interior Wall (Masonry)</i></p>

400

Element modeling to include:

- Reinforcing
- Connections
- Grouting Material
- Jams
- Bond Beams
- Lintels
- Member fabrication part number
- Any part required for complete installation

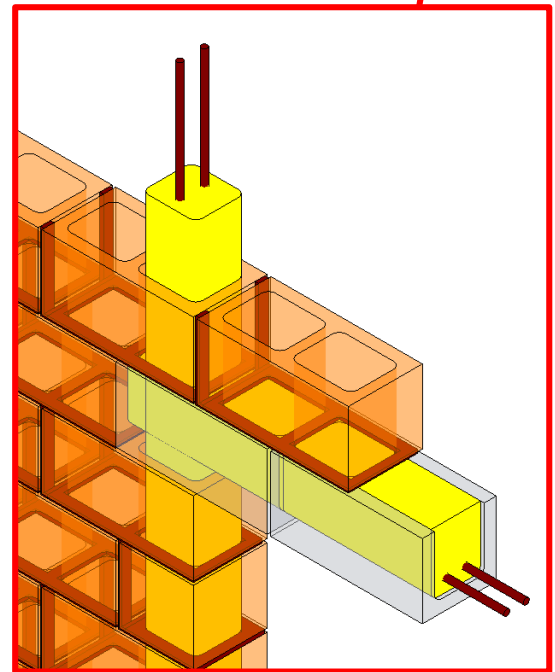
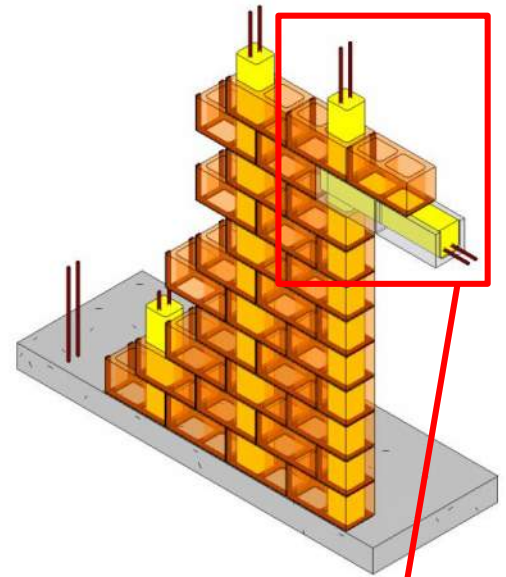

78 C1010.04-LOD-400 Interior Wall (Masonry)

C1010 – Interior Wall (Cold-Form Metal Framing)

100	See C10	
200	See C1010	 <p data-bbox="886 674 1458 730"><i>79 C1010.05-LOD-200 Interior Wall (Cold-Form Metal Framing)</i></p>
300	See C1010	 <p data-bbox="898 1226 1469 1283"><i>80 C1010.05-LOD-300 Interior Wall (Cold-Form Metal Framing)</i></p>

350

Cold formed metal framing is developed with sufficient elements to support detailed interface coordination with other systems such as MEP.

Image notes:

- 1) *Elements in red are critical wall support elements that cannot be easily cut for coordination of MEP opening through the walls.*
- 2) *Diagonal bracing (kickers) that may be in the above ceiling space are modeled for coordination with other building content such as MEP passing along the wall in the above ceiling spaces.*
- 3) *Infill CFMF modeling (Orange) may be omitted at this LOD if stated in the BXP.*
- 4) *Cladding and sheathing are not shown for clarity in this image.*

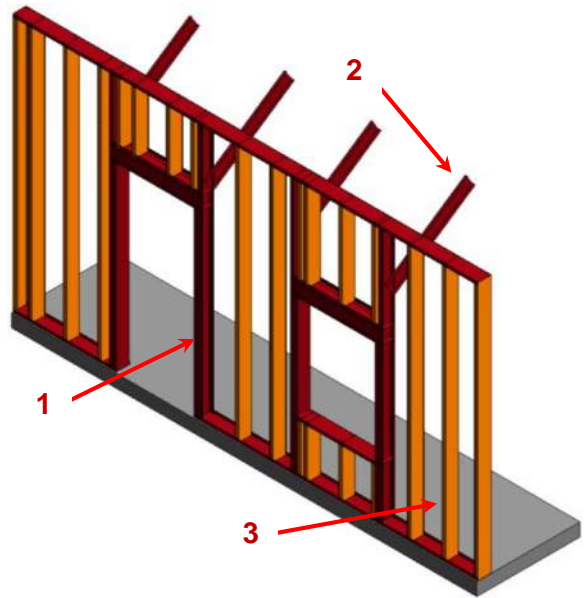

81 C1010.05-LOD-350 Interior Wall (Cold-Form Metal Framing)

400

Cold formed metal framing is developed with sufficient elements that support the fabrication of the CFMF system.

Image notes:

- 1) *Connection content is development in the wall elements. This includes but is not limited to fasteners, clips, and other related hardware.*
- 2) *Cladding and sheathing are not shown for clarity in this image.*

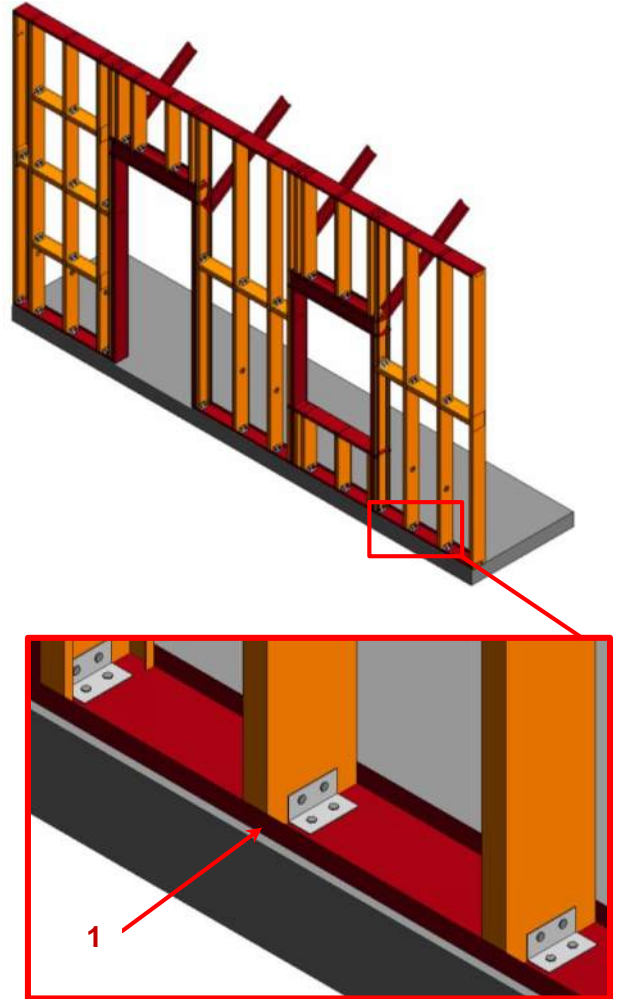

82 C1010.05-LOD-400 Interior Wall (Cold-Form Metal Framing)

C1010 – Interior Wall (Wood)

100	See C10	
200	See C1010	 <p data-bbox="917 747 1377 779"><i>83 C1010.06-LOD-200 Interior Wall (Wood)</i></p>
300	See C1010	 <p data-bbox="922 1377 1382 1409"><i>84 C1010.06-LOD-300 Interior Wall (Wood)</i></p>

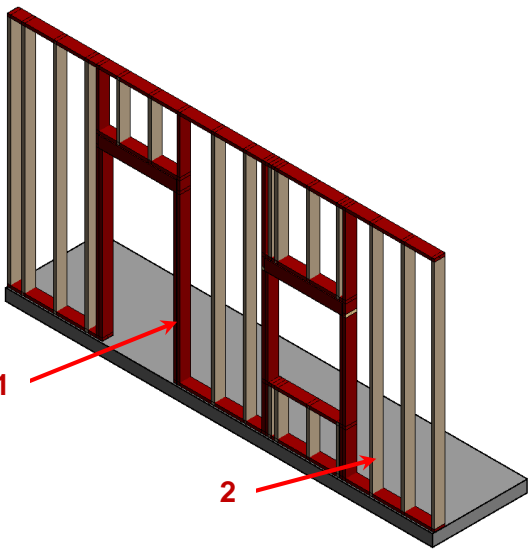
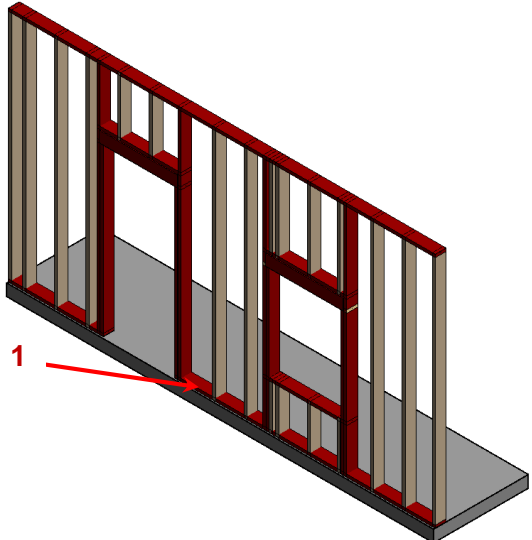
<p>350</p>	<p>Wood framing is developed with sufficient elements to support detailed interface coordination with other systems such as MEP.</p> <p><i>Image notes:</i></p> <ol style="list-style-type: none">1) <i>Elements in red are critical wall support elements that cannot be easily cut for coordination of MEP opening through the walls.</i>2) <i>Infill wood framing modeling may be omitted at this LOD if stated in the BXP.</i>3) <i>Cladding and sheathing are not shown for clarity in this image.</i>	 <p>85 C1010.06-LOD-350 Interior Wall (Wood)</p>
<p>400</p>	<p>Wood framing is developed with sufficient elements that support the fabrication of the wood framing system.</p> <p><i>Image notes:</i></p> <ol style="list-style-type: none">1) <i>Connection content is development in the wall elements. This includes but is not limited to fasteners, anchor rods, and other related hardware.</i>2) <i>Cladding and sheathing are not shown for clarity in this image.</i>	 <p>86 C1010.06-LOD-400 Interior Wall (Wood)</p>

C1010.10 – Interior Fixed Partitions

100	See C10	
200	See C1010	
300	<p>Composite model assembly by type with overall thickness that accounts for framing and finish specified for the wall system. (Refer to LOD350 and LOD400 for individually modeled elements)</p> <p>Wall elements are modeled to specific layouts, locations, heights, and elevation profiles. Penetrations are modeled to nominal dimensions for major wall openings such as windows, doors, and large mechanical elements.</p> <p>Required non-graphic information associated with model elements includes:</p> <ul style="list-style-type: none"> • Wall type • Fire rating 	
350	<p>Structure and finish layers of partition assembly modeled as separate elements.</p> <p>All openings modeled to rough dimensions.</p> <p>Major framing elements such as king studs, kickers, diagonal bracing, and headers are modeled.</p>	
400	<p>Element modeling to include:</p> <ul style="list-style-type: none"> • Studs and tracks • Bracing • Insulation • Sheathing or wall boards • Openings/penetrations 	

C1010.20 – Interior Glazed Partitions

100	See C10	
200	See C1010	
300	<p>Specified location and orientation of face of glass.</p> <p>Nominal face dimensions and thickness of glazing.</p> <p>Structural support systems of wall to be modeled.</p> <p>Spacing, location, size and orientation of mullions.</p> <p>Operable components defined (doors) and included in model.</p>	
350	<ul style="list-style-type: none"> • Mullion shapes and geometry defined. • Actual anchorage layouts and types defined. • Actual panel dimensions (including seating). 	
400	<ul style="list-style-type: none"> • Complete mullion extrusion profiles. • Interface details between wall systems (within) and wall and support systems. 	

C1010.40 – Interior Demountable Partitions

100	See C10	
200	See C1010	
300	See C1010.10	

350	See C1010.10 – also include hardware, accessories, and support structure.	
400	See C1010.10	

C1010.50 – Interior Operable Partitions

100	See C10	
200	See C1010	
300	Operable partition system modeled to include spatial requirements for open/storage position and closed position. Spatial requirements for structure (overhead or below) to be modeled.	
350	Major support elements (overhead or below) Mechanical connections	
400	All assembly components including tracks, panels, hardware and supports.	

C1010.70 – Interior Screens

Portable and open dividers.

[See [C1010.10](#)]

C1010.90 – Interior Partitions Supplementary Components

Sound isolation components, firestopping, and expansion control to be included with interior partition elements above as appropriate.

These components are typically modeled as part of other assemblies listed in the tables above. Do not assign this Uniformat classification unless a supplementary component is modeled independently of another assembly.

C1020 – Interior Windows

100	See C10	
200	Windows approximate in terms of location, size, count and type. Units are modeled as a simple, monolithic component; or represented with simplified frame and glazing. Nominal unit size is provided.	

C1020.10 – Interior Operating Windows

100	See C10	
200	See C1020	
300	Units are modeled based on specified location and nominal size. Outer geometry of window frame elements and glazing modeled. Operation is indicated. Non-graphic information associated with model element: <ul style="list-style-type: none"> • Aesthetic characteristics (finishes, glass types) • Performance characteristics (i.e. U-value, wind loading, blast resistance, structural, air, thermal, water, sound) • Functionality of the window (fixed, casement, double/single hung, awning/project out, pivot, sliding) 	
350	Rough opening dimensions Attachment method of window to structure Embed geometry	
400	Frame profiles Glazing sub-components (gaskets) Attachment components	

C1020.20 – Interior Fixed Windows

[See [C1020.10](#)]

C1020.50 – Interior Special Function Windows

[See [C1020.10](#)]

C1020.90 – Interior Window Supplementary Components

Frames, sills, operating hardware, glazing to be included with interior window elements above as appropriate.

These components are typically modeled as part of other assemblies listed in the tables above. Do not assign this Unifomat classification unless a supplementary component is modeled independently of another assembly.

C1030 – Interior Doors

100	See C10	
200	Units are modeled as a simple, monolithic component; or represented with simple frame and panel. Nominal unit size is provided.	

C1030.10 – Interior Swinging Doors

100	See C10	
200	See C1030	
300	Door assemblies modeled by type to include the following: <ul style="list-style-type: none"> • Specific door panels and frames (if applicable). • Hardware set functionality and types are specified in non-graphic information. • Operation is specified • Spatial requirements for operation are modeled. 	
350	Rough opening is modeled in containing wall. Major framing elements are modeled at jambs and head in containing wall. Operation or mechanism enclosures are modeled, if applicable.	
400	Actual frame/mullion extrusions. Actual panel size dimensions. All connections and interfaces modeled including brackets, supports, sealants, and thresholds.	

C1030.20 – Interior Entrance Doors

Exterior personnel door assemblies at interior main entrances. Includes automatic, revolving, balanced, and other special operating entrance doors, and sliding storefront wall systems. Includes Interior Door Supplementary Components as appropriate when not part of storefront system.

[See [B2050.10](#)]

C1030.25 – Interior Sliding Doors

[See [C1030.10](#)]

C1030.30 – Interior Folding Doors

[See [C1030.10](#)]

C1030.40 – Interior Coiling Doors

100	See C10	
200	See C1030	
300	Coiling door assemblies modeled by type to include the following: <ul style="list-style-type: none"> • Door panels with nominal dimensions. • Frames with nominal dimensions. • Hardware set functionality and types included in non-graphic information. • Clearance zones are modeled for operation of overhead doors. • Enclosures and motor housings are modeled with overall nominal dimensions. 	
350	Rough opening is modeled (if applicable). Major framing elements in wall are modeled at jambs and head. Other major structural support elements are modeled.	
400	All connections and interfaces modeled including brackets, supports, sealants, and thresholds.	

C1030.50 – Interior Panel Doors

Interior large opening doors constructed of panels that move.

[See [C1030.40](#)]

C1030.70 – Interior Special Function Doors

Interior door assemblies for a variety of special functions and applications involving a variety of operating methods. Includes Interior Door Supplementary Components as appropriate.

[See [C1030.40](#)]

C1030.80 – Interior Access Doors and Panels

[See [C1030.40](#)]

C1030.90 – Interior Door Supplementary Components

Frames, hardware, glazing, and louvers that are part of door to be included with interior door elements above as appropriate.

These components are typically modeled as part of other assemblies listed in the tables above. Do not assign this Unifomat classification unless a supplementary component is modeled independently of another assembly.

C1040 – Interior Grilles and Gates

100	See C10	
200	See C1030	

C1040.10 – Interior Grilles

100	See C10	
200	See C1030	
300	Grille assemblies modeled by type to include the following: <ul style="list-style-type: none"> Nominal size of unit. Required openness provided as non-graphic information. Operation is specified graphically and with non-graphic information, if applicable. 	
350	Rough opening is modeled (if applicable). Major framing elements are modeled at jambs and head.	
400	All connections and interfaces modeled including brackets, supports, sealants, and thresholds.	

C1040.50 – Interior Gates

[See [C1040.10](#)]

C1060 – Raised Floor Construction

100	See C10	
200	Generic assembly that contains spatial (layer) allowance for support system and flooring material.	

C1060.10 – Access Flooring

100	See C10	
200	See C1060	
300	Overall flooring assembly modeled by type to specified thickness/depth. Major openings such as shafts are modeled.	
350	Individual layers of assembly are modeled separately. All openings and penetrations are modeled. Expansion joints are modeled indicating specific width. Pedestals are modeled and located properly, if applicable.	
400	All assembly components are modeled including frame, floor tiles, pedestals, and cross bracing.	

C1060.30 – Platform/Stage Floors

[See [C1060.10](#)]

C1070 – Suspended Ceiling Construction

100	Ceiling construction is represented in other composite objects such as floors or rooms; or, schematic model elements that are not distinguishable by type or material. Assembly depth/thickness and locations still flexible.	
200	Generic assemblies indicative of overall scope and approximate thickness/system depth of suspended ceiling.	

C1070.10 – Acoustical Suspended Ceilings

100	See C1070	
200	See C1070	
300	Overall assembly modeled to specific system thickness including structural backing. Location of expansion or control joints indicated, but not modeled.	
350	Ceiling suspension grid is modeled. Structural backing members including bracing/lateral framing/kickers are modeled. Expansion or control joints are modeled to indicate specific width.	
400	All assembly components are modeled including tees, hangers, support structure, and tiles.	

C1070.20 – Suspended Plaster and Gypsum Board Ceilings

100	See C1070	
200	See C1070	
300	Overall assembly modeled to specific system thickness including framing. Major penetrations are modeled.	
350	Major bracing elements or kickers.	
400	All assembly components including furring channels, hangers, lath, plaster coats, and gypsum boards.	

C1070.50 – Specialty Suspended Ceilings

[See [C1070.10](#) or [C1070.20](#)]

C1070.70 – Special Function Suspended Ceilings

[See [C1070.10](#) or [C1070.20](#)]

C1070.90 – Ceiling Suspension Components

Hangers and framing to suspend ceiling and sound isolation components to be included with suspended ceiling construction elements above as appropriate.

These components are typically modeled as part of other assemblies listed in the tables above. Do not assign this Unifomat classification unless a supplementary component is modeled independently of another assembly.

C1090 – Interior Specialties

100	See C10	
-----	-------------------------	--

200	<p>Generic model elements with approximate nominal size.</p> <p>Placement and quantity remains flexible.</p> <p>Required non-graphic information associated with model elements includes included with element:</p> <ul style="list-style-type: none"> • Type of object 	
-----	--	--

C1090.10 – Interior Railings and Handrails

100	See C10	
200	Generic model element representing approximate overall height and location of railing/handrail.	
300	<p>Railing/handrail systems modeled by type to include:</p> <ul style="list-style-type: none"> • All horizontal rails • All vertical posts/balusters 	
350	Mounting/attachment components	
400	All assembly components including fasteners and supports.	

C1090.15 – Interior Louvers

Interior louvers, and other items for ventilation which are not an integral part of the mechanical system. Includes operable and stationary louvers.

100	See C10	
200	Generic model element that is indicative of approximate area and location of louver.	
300	Louver assembly modeled by type, indicative of area and location of intended louver/vent. Includes accurate frame (boundary dimensions) and blades. Opening for louver is cut from host wall. Performance level defined in non-graphic information (e.g. storm proof or not, free air).	
350	Rough opening is modeled (if applicable) Major framing elements are modeled at jambs and head. Connection points are modeled.	
400	All connections and interfaces modeled including brackets, supports, and sealants.	

C1090.20 – Information Specialties

Visual display units, display cases, directories, interior signage, telephone specialties, and informational kiosks.

[See [Fundamental LOD Definitions](#)]

C1090.25 – Compartments and Cubicles

Manufactured compartments and cubicles for specific purposes. Includes toilet compartments, shower stalls, etc.

[See [Fundamental LOD Definitions](#)]

C1090.30 – Service Walls

Wall assemblies and wall-mounted units incorporating services.

[See [C1010.10](#)]

C1090.35 – Wall and Door Protection

Manufactured protective devices for walls and doors. Includes corner guards, bumper guards, and protective wall covering.

[See [Fundamental LOD Definitions](#)]

C1090.40 – Toilet, Bath and Laundry Accessories

Manufactured items for use in conjunction with toilets, baths, and laundries.

[See [Fundamental LOD Definitions](#)]

C1090.45 – Interior Gas Lighting

[See [Fundamental LOD Definitions](#)]

C1090.50 – Fireplaces and Stoves

[See [Fundamental LOD Definitions](#)]

C1090.60 – Safety Specialties

[See [Fundamental LOD Definitions](#)]

C1090.70 – Storage Specialties

[See [Fundamental LOD Definitions](#)]

C1090.90 – Other Interior Specialties

[See [Fundamental LOD Definitions](#)]

C20 Interior Finishes

100	Non-graphic information attached to model elements providing assumptions about proposed finish materials.	
-----	---	--

C2010 – Wall Finishes

100	See C20	
200	Generic materials by type (e.g. tile or paneling), approximate thickness and scope in elevation. Generally, materials over 0.25" (10mm) thick are modeled.	
300	Materials are modeled based on specific types (e.g. Tile type CT-1). Thickness and scope are accurately modeled.	
350	Additional non-graphic information to include: <ul style="list-style-type: none"> • Manufacturer • Model 	
400	Pattern layouts Expansion/control joints Edges	

C2010.10 –Tile Wall Finish

[See [C2010](#)]

C2010.20 – Wall Paneling

[See [C2010](#)]

C2010.30 – Wall Coverings

[See [C2010](#)]

C2010.35 – Wall Carpeting

[See [C2010](#)]

C2010.50 – Stone Facing

[See [C2010](#)]

C2010.60 – Special Wall Surfacing

[See [C2010](#)]

C2010.70 – Wall Painting and Coating

[See [C2010](#)]

C2010.80 – Acoustical Wall Treatment

[See [C2010](#)]

C2010.90 – Wall Finish Supplementary Components

Furring to be included with wall finish elements above as appropriate.

[See [C1010](#)]

C2020 – Interior Fabrications

[See [Fundamental LOD Definitions](#)]

C2030 – Flooring

[See [C2010](#)]

C2040 – Stair Finishes

[See [C2010](#)]

C2050 – Ceiling Finishes

[See [C1070](#)]

D: SERVICES

D10 Conveying

100	Schematic model elements that are not distinguishable by type or material. Component sizes and locations still flexible.	
-----	---	--

D1010 – Vertical Conveying Systems

100	See D10	
200	Generic representation of the system envelope, including critical path of travel zones.	

D1010.10 – Elevators

100	See D10	
200	See D1010	
300	Specific system elements modeled by type, including all path of travel zones. Pits and/or control rooms and associated equipment to be modeled if applicable. Major structural support elements modeled. Connections to mechanical or electrical services. Non-graphic information to be included with modeled elements: <ul style="list-style-type: none"> • Type code (referenced in specifications) • ClearWidth • ClearDepth • ClearHeight 	
350	Sizing adjusted to the actual manufacturer specifications. Guiding tracks/rails Service/access zones	
400	All connections, supports, framing, and other supplementary components.	

D1010.20 – Lifts

[See [D1010.10](#)]

D1010.30 – Escalators

[See [D1010.10](#)]

D1010.50 – Dumbwaiters

[See [D1010.10](#)]

D1010.60 – Moving Ramps

[See [D1010.10](#)]

D1030 – Horizontal Conveying

[See [D1010.10](#)]

D1030.10 – Moving Walks

[See [D1010.10](#)]

D1030.30 – Turntables

[See [D1010.10](#)]

D1030.50 – Passenger Loading Bridges

[See [D1010.10](#)]

D1030.70 – People Movers

[See [D1010.10](#)]

D1050 – Material Handling

100	See D10	
200	Generic representation of the material handling system envelope, including critical path of travel zones.	

D1050.10 – Cranes

100	See D10	
200	See D1050	
300	<p>Specific system elements modeled by type, including all path of travel/boom swing zones.</p> <p>Lay-down/pick-up zones are modeled.</p> <p>Major structural support elements modeled.</p> <p>Connections to mechanical or electrical services.</p> <p>Non-graphic information to be associated with modeled elements:</p> <ul style="list-style-type: none"> Type code 	
350	<p>Sizing adjusted to the actual manufacturer specifications.</p> <p>Guiding tracks/rails</p> <p>Service/access zones</p>	
400	All connections, supports, framing, and other supplementary components.	

D1050.20 – Hoists

[See [D1050.10](#)]

D1050.30 – Derrecks

[See [D1050.10](#)]

D1050.40 – Conveyors

[See [D1050.10](#)]

D1050.50 – Baggage Handling Equipment

100	See D10	
200	See D1050	
300	See Fundamental LOD Definitions	
350	See Fundamental LOD Definitions	
400	See Fundamental LOD Definitions	

D1050.60 – Chutes

[See [D1050.10](#)]

D1050.70 – Pneumatic Tube Systems

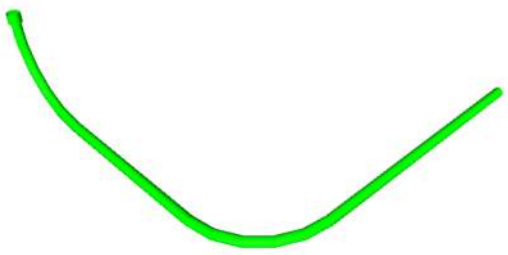
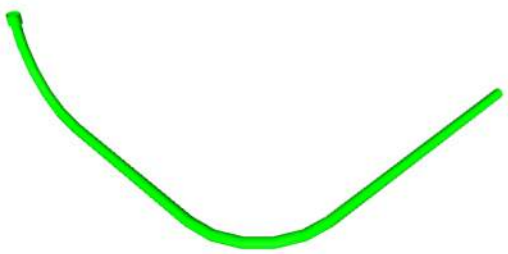
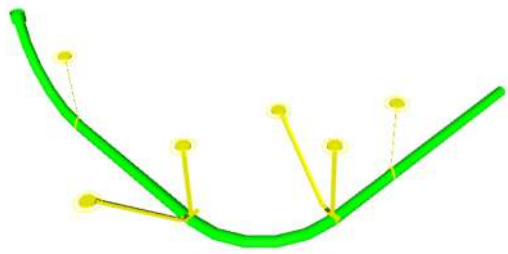
<p>100</p>	<p>Diagrammatic elements or quantitative call outs; conceptual and/or schematic flow diagrams; Non-graphic information associated with model elements includes minimal design performance information.</p>	 <p>87 D1050.70-LOD-100 Pneumatic Tube Systems</p>
<p>200</p>	<p>Generic elements; schematic layout with approximate size, shape, and location of equipment and tubing; Non-graphic information associated with model elements includes design performance information.</p>	 <p>88 D1050.70-LOD-200 Pneumatic Tube Systems</p>
<p>300</p>	<p>Modeled as design-specified elements; specified size, shape, spacing, and location of equipment and tubing; approximate allowances for spacing and clearances required for all specified hangers, supports, vibration and seismic control that are to be utilized in the layout of all equipment and tubing; actual access/code clearance requirements modeled.</p>	 <p>89 D1050.70-LOD-300 Pneumatic Tube Systems</p>
<p>350</p>	<p>Modeled as <i>actual construction</i> elements; actual size, shape, spacing, and location/connections of equipment and tubing; actual size, shape, spacing, and clearances required for all hangers, supports, vibration and seismic control that are utilized in the layout of all equipment and tubing; floor and wall penetrations modeled.</p>	 <p>90 D1050.70-LOD-350 Pneumatic Tube Systems</p>

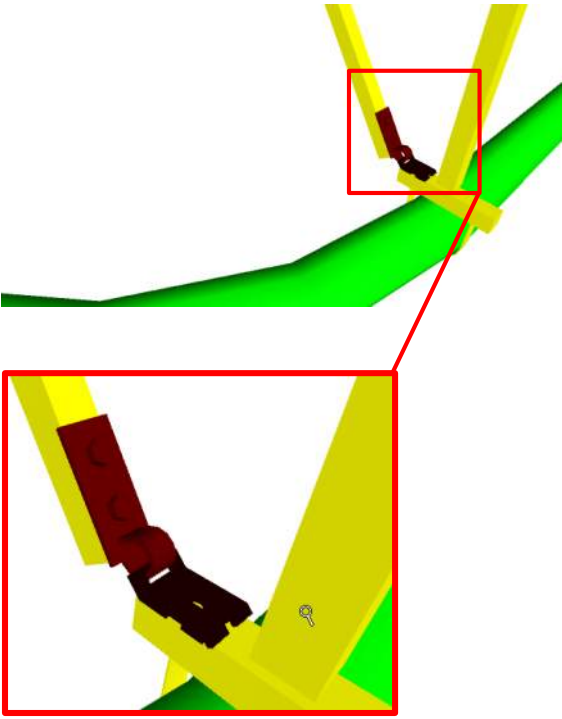
400	Supplementary components added to the model required for fabrication and field installation	 <p data-bbox="971 949 1494 982"><i>91 D1050.70-LOD-400 Pneumatic Tube Systems</i></p>
-----	---	--

D1080 – Operable Access Systems

[See [Fundamental LOD Definitions](#)]

D1080.10 – Suspended Scaffolding

[See [Fundamental LOD Definitions](#)]

D1080.20 – Rope Climbers

[See [Fundamental LOD Definitions](#)]

D1080.30 – Elevating Platforms

[See [Fundamental LOD Definitions](#)]

D1080.40 – Powered Scaffolding

[See [Fundamental LOD Definitions](#)]

D1080.50 – Building Envelope Access

[See [Fundamental LOD Definitions](#)]

D20 Plumbing

100	Diagrammatic or schematic model elements; conceptual and/or schematic layout/flow diagram; design performance parameters as defined in the BIMXP to be associated with model elements as non-graphic information.	
-----	---	--

D2010 – Domestic Water Distribution

100	See D20	
200	Schematic layout of generic model elements with approximate size, shape, and location of elements; approximate access/code clearance requirements; shaft requirements modeled; design performance parameters as defined in the BIMXP to be associated with model elements as non-graphic information.	

D2010.10 – Facility Potable-Water Storage Tanks

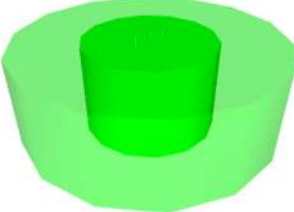
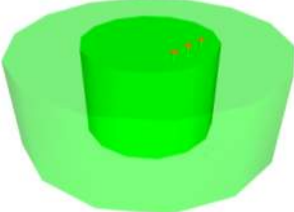
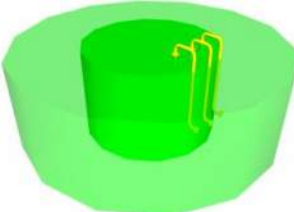
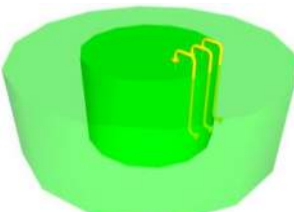
100	See D20	
200	<p>Schematic layout with approximate size, shape, and location of tank(s);</p> <p>approximate access/code clearance requirements modeled;</p> <p>design performance parameters as defined in the BIMXP to be associated with model elements as non-graphic information.</p>	 <p><i>92 D2010.10-LOD-200 Facility Potable-Water Storage Tanks</i></p>
300	<p>Modeled as design-specified size, shape, spacing, and location of tank(s);</p> <p>approximate allowances for spacing and clearances required for all specified anchors, supports, vibration and seismic control that are utilized in the layout of tanks(s);</p> <p>actual access/code clearance requirements modeled.</p>	 <p><i>93 D2010.10-LOD-300 Facility Potable-Water Storage Tanks</i></p>
350	<p>Modeled as actual construction elements <i>size and shape, spacing, and location/connections</i> of tank(s) actual size and shape, spacing, and clearances required for all specified anchors, supports, vibration and seismic control that are utilized in the layout of tanks(s).</p>	 <p><i>94 D2010.10-LOD-350 Facility Potable-Water Storage Tanks</i></p>
400	<p>Supplementary components added to the model required for fabrication and field installation.</p>	 <p><i>95 D2010.10-LOD-400 Facility Potable-Water Storage Tanks</i></p>



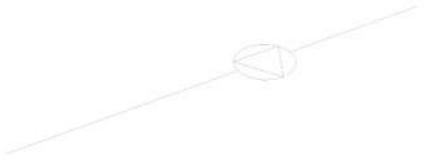
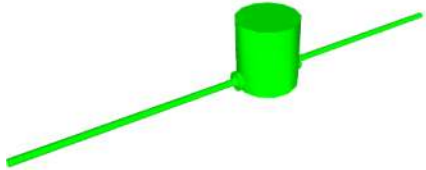
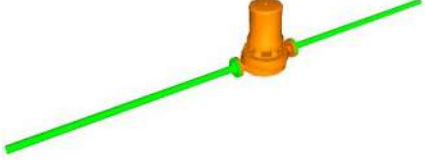
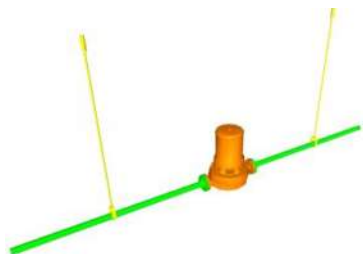
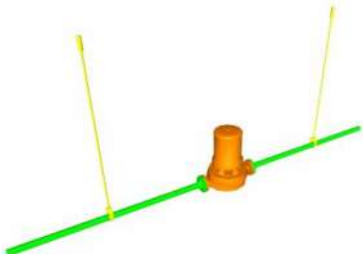

D2010.20 – Domestic Water Equipment

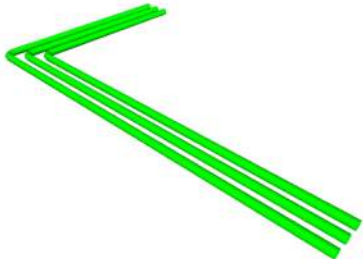
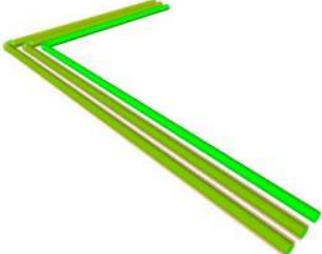
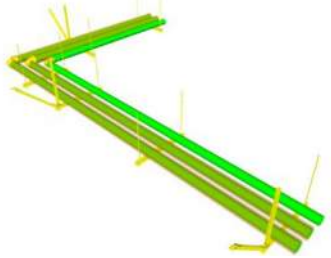
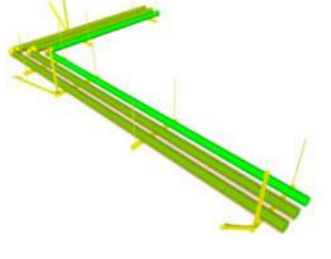
100	See D20	 <p><i>96 D2010.20-LOD-100 Domestic Water Equipment</i></p>
200	<p>Schematic layout with approximate size, shape, and location of equipment; approximate access/code clearance requirements modeled;</p> <p>design performance parameters as defined in the BIMXP to be associated with model elements as non-graphic information.</p>	 <p><i>97 D2010.20-LOD-200 Domestic Water Equipment</i></p>
300	<p>Modeled as design-specified size, shape, spacing, and location of equipment;</p> <p>approximate allowances for spacing and clearances required for all specified anchors, supports, vibration and seismic control that are utilized in the layout of equipment;</p> <p>actual access/code clearance requirements modeled.</p>	 <p><i>98 D2010.20-LOD-300 Domestic Water Equipment</i></p>
350	<p>Modeled as actual construction elements size, shape, spacing, and location/connections of equipment;</p> <p>actual size, shape, spacing, and clearances required for all specified anchors, supports, vibration and seismic control that are utilized in the layout of equipment.</p>	 <p><i>99 D2010.20-LOD-350 Domestic Water Equipment</i></p>
400	See D2010.10	 <p><i>100 D2010.20-LOD-400 Domestic Water Equipment</i></p>

D2010.40 – Domestic Water Piping

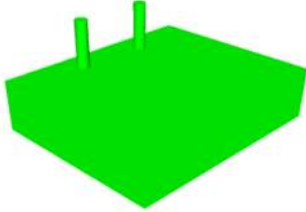
100	<p>Diagrammatic or schematic model elements; conceptual and/or schematic flow diagrams; design performance parameters as defined in the BIMXP to be associated with model elements as non-graphic information.</p>	
200	<p>Schematic layout with approximate size, shape, and location of mains and risers; shaft requirements modeled; design performance parameters as defined in the BIMXP to be associated with model elements as non-graphic information.</p>	 <p><i>101 D2010.40-LOD-200 Domestic Water Piping</i></p>
300	<p>Modeled as design-specified size, shape, spacing, and location of pipe, valves, fittings, and insulation for risers, mains, and branches; approximate allowances for spacing and clearances required for all specified hangers, supports, vibration and seismic control that are to be utilized in the layout of all risers, mains, and branches; actual access/code clearance requirements modeled.</p>	 <p><i>102 D2010.40-LOD-300 Domestic Water Piping</i></p>
350	<p>Modeled as actual construction elements; actual size, shape, spacing, and location/connections of pipe, valves, fittings, and insulation for risers, mains, and branches; actual size, shape, spacing, and clearances required for all hangers, supports, vibration and seismic control that are utilized in the layout of all risers, mains, and branches; actual floor and wall penetrations modeled.</p>	 <p><i>103 D2010.40-LOD-350 Domestic Water Piping</i></p>
400	<p>See D2010.10</p>	 <p><i>104 D2010.40-LOD-400 Domestic Water Piping</i></p>

D2010.60 – Plumbing Fixtures

100	See D20	
200	<p>Schematic layout with approximate size, shape, and location of fixtures;</p> <p>carrier and wall width requirements modeled;</p> <p>design performance parameters as defined in the BIMXP to be associated with model elements as non-graphic information.</p>	 <p><i>105 D2010.60-LOD-200 Plumbing Fixtures</i></p>
300	<p>Modeled as design-specified size, shape, spacing, and location of fixtures;</p> <p>approximate allowances for spacing and clearances required for all specified supports that are to be utilized in the layout of all fixtures;</p> <p>actual access/code clearance requirements modeled.</p>	 <p><i>106 D2010.60-LOD-300 Plumbing Fixtures</i></p>
350	<p>Modeled as actual construction elements size, shape, spacing, and location/connections of fixtures/carriers;</p> <p>actual size, shape, spacing, and clearances required for all supports that are utilized in the layout of all fixtures.</p>	 <p><i>107 D2010.60-LOD-350 Plumbing Fixtures</i></p>
400	See D2010.10	 <p><i>108 D2010.60-LOD-400 Plumbing Fixtures</i></p>

D2010.90 – Domestic Water Distribution Supplementary Components





Includes expansion fittings, meters, gages, valves, hangers, supports, heat tracing, vibration and seismic controls.

These components are typically modeled as part of other assemblies listed in the tables above. Do not assign this Unifomat classification unless a supplementary component is modeled independently of another assembly.

D2020 – Sanitary Drainage

100	See D20	
200	See D2010	

D2020.10 – Sanitary Sewerage Equipment

100	See D20	
200	<p>Schematic layout with approximate size, shape, and location of equipment;</p> <p>design performance parameters as defined in the BIMXP to be associated with model elements as non-graphic information.</p>	 <p><i>109 D2020.10-LOD-200 Sanitary Sewerage Equipment</i></p>
300	<p>Modeled as design specified size, shape, spacing, and location of equipment;</p> <p>approximate allowances for spacing and clearances required for all specified anchors, supports, vibration and seismic control that are utilized in the layout of equipment; actual access/code clearance requirements modeled.</p>	 <p><i>110 D2020.10-LOD-300 Sanitary Sewerage Equipment</i></p>
350	<p>Actual size, shape, spacing, and clearances required for all specified anchors, supports, vibration and seismic control that are utilized in the layout of equipment;</p> <p>actual access/code clearance requirements modeled.</p>	 <p><i>111 D2020.10-LOD-350 Sanitary Sewerage Equipment</i></p>
400	<p>Supplementary components added to the model required for fabrication and field installation</p>	 <p><i>112 D2020.10-LOD-400 Sanitary Sewerage Equipment</i></p>

D2020.30 – Sanitary Sewerage Piping

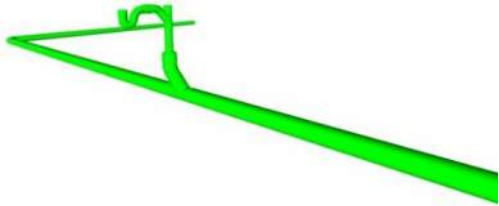
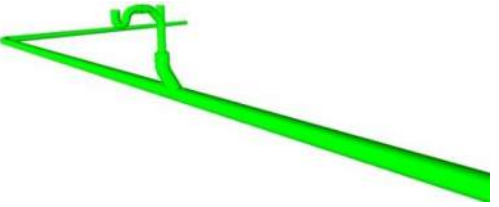
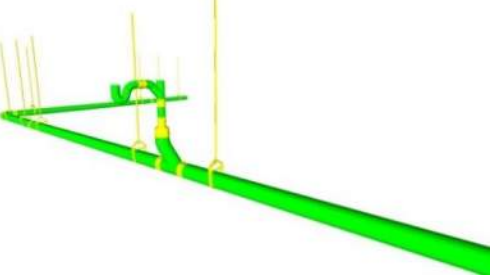
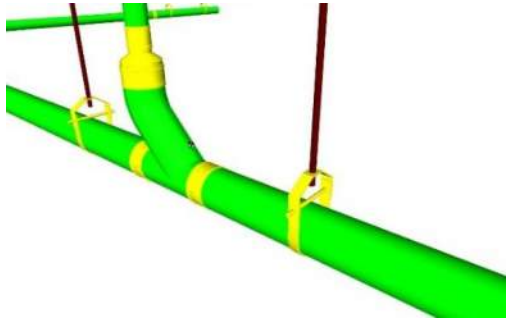
100	See D20	
200	Schematic layout with approximate size, shape, and location of mains and risers; shaft requirements modeled; design performance parameters as defined in the BIMXP to be associated with model elements as non-graphic information.	 <p data-bbox="966 594 1502 625"><i>113D2020.30-LOD-200 Sanitary Sewerage Piping</i></p>
300	Modeled as design-specified size, shape, spacing, location, and slope of pipe, valves, fittings, and insulation for risers, mains, and branches; approximate allowances for spacing and clearances required for all specified hangers, supports, vibration and seismic control that are to be utilized in the layout of all risers, mains, and branches; actual access/code clearance requirements modeled	 <p data-bbox="966 934 1502 966"><i>114D2020.30-LOD-300 Sanitary Sewerage Piping</i></p>
350	Modeled as actual construction elements; actual size, shape, spacing, location, connections, and slope of pipe, valves, fittings, and insulation for risers, mains, and branches; actual size, shape, spacing, and clearances required for all hangers, supports, vibration and seismic control that are utilized in the layout of all risers, mains, and branches; actual floor and wall penetrations modeled.	 <p data-bbox="966 1333 1502 1365"><i>115D2020.30-LOD-350 Sanitary Sewerage Piping</i></p>
400	See D2020.10	 <p data-bbox="990 1816 1526 1848"><i>116D2020.30-LOD-400 Sanitary Sewerage Piping</i></p>

D2020.90 – Sanitary Drainage Supplementary Components



Includes expansion fittings, meters, gages, valves, hangers, supports, heat tracing, vibration and seismic controls.

These components are typically modeled as part of other assemblies listed in the tables above. Do not assign this Unifomat classification unless a supplementary component is modeled independently of another assembly.

D2030 – Building Support Plumbing Systems

100	See D20	
200	See D2010	

D2030.10 – Stormwater Drainage Equipment

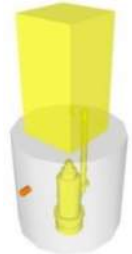

<p>100</p>	<p>Diagrammatic or schematic model elements; conceptual and/or schematic layout; design performance parameters as defined in the BIMXP to be associated with model elements as non-graphic information.</p>	
<p>200</p>	<p>Schematic layout with approximate size, shape, and location of equipment; approximate access/code clearance requirements modeled; design performance parameters as defined in the BIMXP to be associated with model elements as non-graphic information.</p>	 <p><i>117 D2030.10-LOD-200 Stormwater Drainage Equipment</i></p>
<p>300</p>	<p>Modeled as design-specified size, shape, spacing, and location of equipment; approximate allowances for spacing and clearances required for all specified anchors, supports, vibration and seismic control that are utilized in the layout of equipment; actual access/code clearance requirements modeled.</p>	 <p><i>118 D2030.10-LOD-300 Stormwater Drainage Equipment</i></p>
<p>350</p>	<p>Modeled as actual construction elements size, shape, spacing, and location/connections of equipment, actual size, shape, spacing, and clearances required for all specified anchors, supports, vibration and seismic control that are utilized in the layout of equipment; actual access/code clearance requirements modeled.</p>	 <p><i>119 D2030.10-LOD-350 Stormwater Drainage Equipment</i></p>
<p>400</p>	<p>Supplementary components added to the model required for fabrication and field installation.</p>	 <p><i>120 D2030.10-LOD-400 Stormwater Drainage Equipment</i></p>

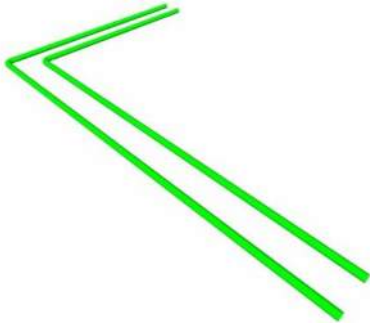
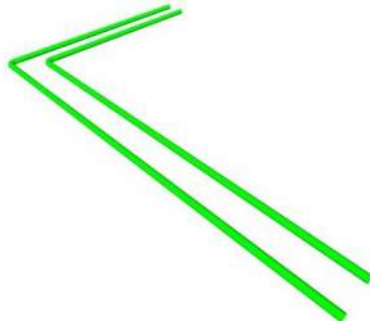
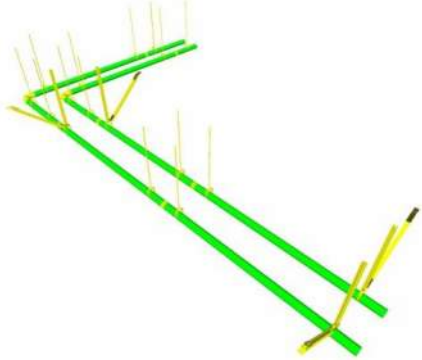
D2030.20 – Stormwater Drainage Piping

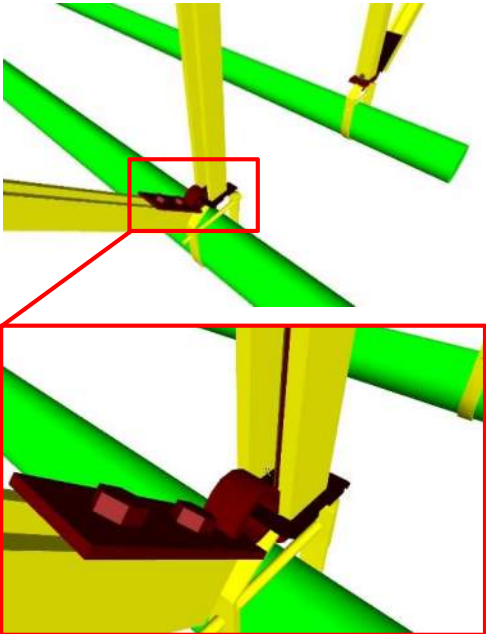
100	See D20	
200	<p>Schematic layout with approximate size, shape, and location of mains and risers;</p> <p>shaft requirements modeled;</p> <p>design performance parameters as defined in the BIMXP to be associated with model elements as non-graphic information.</p>	 <p><i>121 D2030.20-LOD-200 Stormwater Drainage Piping</i></p>
300	<p>Modeled as design-specified size, shape, spacing, location, and slope of pipe, valves, fittings, and insulation for risers, mains, and branches;</p> <p>approximate allowances for spacing and clearances required for all specified hangers, supports, vibration and seismic control that are to be utilized in the layout of all risers, mains, and branches;</p> <p>actual access/code clearance requirements modeled.</p>	 <p><i>122 D2030.20-LOD-300 Stormwater Drainage Piping</i></p>
350	<p>Modeled as actual size, shape, spacing, location, connections, and slope of pipe, valves, fittings, and insulation for risers, mains, and branches;</p> <p>actual size and shape, spacing, and clearances required for all hangers, supports, vibration and seismic control that are utilized in the layout of all risers, mains, and branches;</p> <p>actual floor and wall penetrations modeled.</p>	 <p><i>123 D2030.20-LOD-350 Stormwater Drainage Piping</i></p>

400	See D2030.10	 <p>124 D2030.20-LOD-400 Stormwater Drainage Piping</p>
-----	------------------------------	---

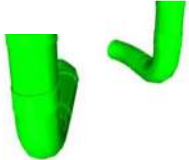
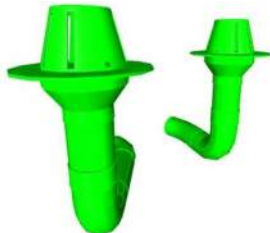
D2030.30 – Facility Stormwater Drains

100	See D20	
200	<p>Schematic layout with approximate size, shape, and location of components;</p> <p>design performance parameters as defined in the BIMXP to be associated with model elements as non-graphic information.</p>	 <p><i>125 D2030.30-LOD-200 Facility Stormwater Drains</i></p>
300	<p>Modeled as design-specified size, shape, spacing, and location of components;</p> <p>approximate allowances for spacing and clearances required for all specified hangers, supports, vibration and seismic control that are to be utilized in the layout of all components;</p> <p>actual access/code clearance requirements modeled.</p>	 <p><i>126 D2030.30-LOD-300 Facility Stormwater Drains</i></p>
350	<p>Modeled as actual construction elements size, shape, spacing, and location/connections of components;</p> <p>actual size, shape, spacing, and clearances required for all hangers, supports, vibration and seismic control that are utilized in the layout of all components.</p>	 <p><i>127 D2030.30-LOD-350 Facility Stormwater Drains</i></p>
400	See D2030.10	 <p><i>128 D2030.30-LOD-400 Facility Stormwater Drains</i></p>

D2030.60 – Gray Water Systems

[See [D2030.20](#)]

D2030.90 – Building Support Plumbing System Supplementary Components

Includes expansion fittings, meters, gages, valves, hangers, supports, heat tracing, vibration and seismic controls.

These components are typically modeled as part of other assemblies listed in the tables above. Do not assign this Uniformat classification unless a supplementary component is modeled independently of another assembly.

D2050 – General Service Compressed-Air

[See [D2060.10](#) – Compressed-Air Systems]

D2060 – Process Support Plumbing Systems

100	See D20	
200	Schematic layout with approximate size, shape, and location of mains and risers; shaft requirements modeled; design performance parameters as defined in the BIMXP to be associated with model elements as non-graphic information.	

D2060.10 – Compressed-Air Systems

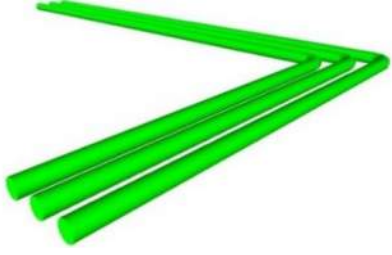
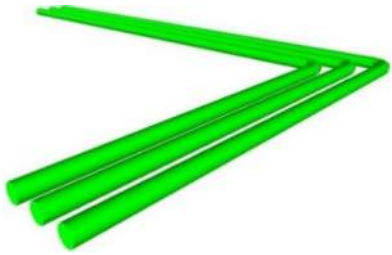
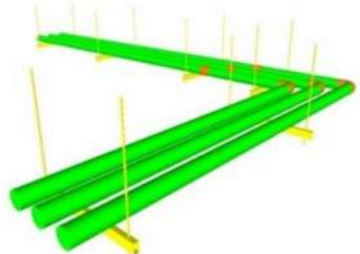
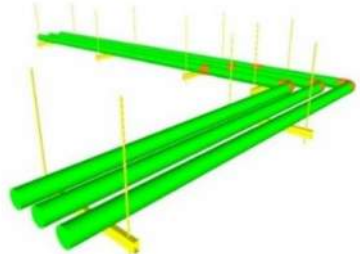
100	See D20	
200	See D2060	 <p data-bbox="959 590 1495 617"><i>129 D2060.10-LOD-200 Compressed-Air Systems</i></p>
300	<p data-bbox="250 646 933 724">Modeled as design-specified size, shape, spacing, location, and slope of equipment/pipe, valves, fittings, and insulation for risers, mains, and branches;</p> <p data-bbox="250 743 933 850">approximate allowances for spacing and clearances required for all specified hangers, supports, vibration and seismic control that are to be utilized in the layout of all risers, mains, and branches;</p> <p data-bbox="250 869 820 896">actual access/code clearance requirements modeled.</p>	 <p data-bbox="959 968 1495 995"><i>130 D2060.10-LOD-300 Compressed-Air Systems</i></p>
350	<p data-bbox="250 1029 933 1106">Modeled as actual size, shape, spacing, location, connections, and slope of equipment/pipe, valves, fittings, and insulation for risers, mains, and branches;</p> <p data-bbox="250 1125 933 1203">actual size, shape, spacing, and clearances required for all hangers, supports, vibration and seismic control that are utilized in the layout of all risers, mains, and branches;</p> <p data-bbox="250 1222 711 1249">actual floor and wall penetrations modeled.</p>	 <p data-bbox="959 1367 1495 1394"><i>131 D2060.10-LOD-350 Compressed-Air Systems</i></p>
400	Supplementary components added to the model required for fabrication and field installation.	 <p data-bbox="959 1766 1495 1793"><i>132 D2060.10-LOD-400 Compressed-Air Systems</i></p>

D2060.20 – Vacuum Systems

[See [D2060.10](#)]

D2060.30 – Gas Systems

[See [D2060.10](#)]

D2060.40 – Chemical-Waste Systems

[See [D2060.10](#)]

D2060.50 – Processed Water Systems

[See [D2060.10](#)]

D2060.90 – Process Support Plumbing System Supplementary Components

Includes expansion fittings, meters, gages, valves, hangers, supports, heat tracing, vibration and seismic controls.

These components are typically modeled as part of other assemblies listed in the tables above. Do not assign this Uniformat classification unless a supplementary component is modeled independently of another assembly.

D30 HVAC

100	Diagrammatic or schematic model elements; conceptual and/or schematic layout/flow diagram; design performance parameters as defined in the BIMXP to be associated with model elements as non-graphic information.	
-----	---	--

D3010 – Facility Fuel Systems

100	See D30	
200	Schematic layout with approximate size, shape, and location of element(s); approximate access/code clearance requirements modeled; shaft requirements modeled; design performance parameters as defined in the BIMXP to be associated with model elements as non-graphic information.	

D3010.10 – Fuel Piping

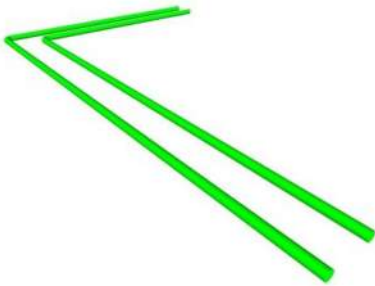
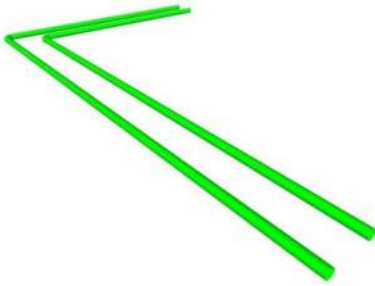
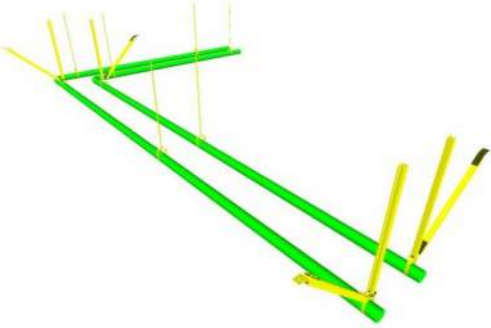
100	See D30	
200	See D3010	 <p data-bbox="938 646 1266 678"><i>133 D3010.10-200 Fuel Piping</i></p>
300	<p data-bbox="248 705 846 783">Modeled as design-specified size, shape, spacing, and location of pipe, valves, fittings, and insulation for risers, mains, and branches;</p> <p data-bbox="248 804 898 909">approximate allowances for spacing and clearances required for all specified hangers, supports, vibration and seismic control that are to be utilized in the layout of all risers, mains, and branches;</p> <p data-bbox="248 930 816 951">actual access/code clearance requirements modeled.</p>	 <p data-bbox="938 1056 1266 1087"><i>134 D3010.10-300 Fuel Piping</i></p>
350	<p data-bbox="248 1110 906 1188">Modeled as actual size, shape, spacing, and location/connections of pipe, valves, fittings, and insulation for risers, mains, and branches;</p> <p data-bbox="248 1209 873 1287">actual size, shape, spacing, and clearances required for all hangers, supports, vibration and seismic control that are utilized in the layout of all risers, mains, and branches;</p> <p data-bbox="248 1308 711 1329">actual floor and wall penetrations modeled.</p>	 <p data-bbox="938 1507 1266 1539"><i>135 D3010.10-350 Fuel Piping</i></p>

<p>400</p>	<p>Supplementary components added to the model required for fabrication and field installation</p>	 <p>136 D3010.10-400 Fuel Piping</p>
------------	--	--

D3010.30 – Fuel Pumps

100	See D30	
200	See D3010	
300	Modeled as design-specified size, shape, spacing, and location of equipment; approximate allowances for spacing and clearances required for all specified anchors, supports, vibration and seismic control that are utilized in the layout of equipment; actual access/code clearance requirements modeled.	
350	Modeled as actual size, shape, spacing, and location/connections of equipment; actual size, shape, spacing, and clearances required for all specified anchors, supports, vibration and seismic control that are utilized in the layout of equipment.	
400	See D3010.10	

D3010.50 – Fuel Storage Tanks

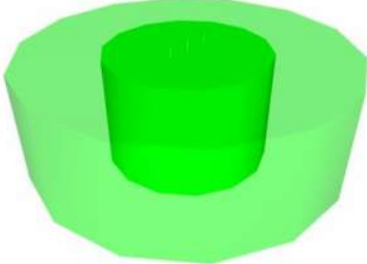
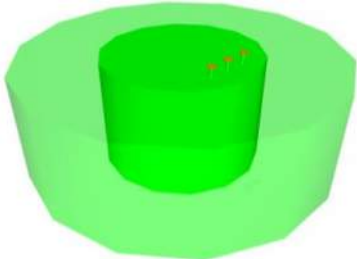
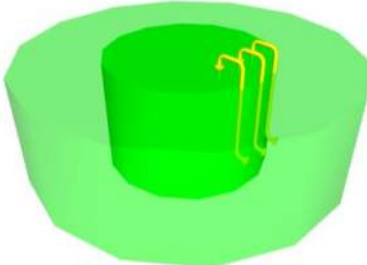
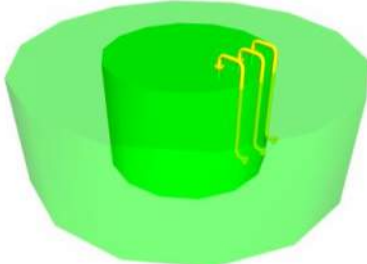
100	See D30	
200	See D3010	 <p data-bbox="959 583 1430 611"><i>137 D3010.50-LOD-200 Fuel Storage Tanks</i></p>
300	<p data-bbox="253 642 927 695">Modeled as design-specified size, shape, spacing, and location of tank(s);</p> <p data-bbox="253 716 927 789">approximate allowances for spacing and clearances required for all specified anchors, supports, vibration and seismic control that are utilized in the layout of tanks(s);</p> <p data-bbox="253 810 821 842">actual access/code clearance requirements modeled.</p>	 <p data-bbox="959 982 1430 1010"><i>138 D3010.50-LOD-300 Fuel Storage Tanks</i></p>
350	<p data-bbox="253 1041 727 1094">Modeled as actual size, shape, spacing, and location/connections of tank(s);</p> <p data-bbox="253 1115 911 1188">actual size, shape, spacing, and clearances required for all specified anchors, supports, vibration and seismic control that are utilized in the layout of tanks(s).</p>	 <p data-bbox="959 1388 1430 1415"><i>139 D3010.50-LOD-350 Fuel Storage Tanks</i></p>
400	See D3010.10	 <p data-bbox="959 1776 1430 1803"><i>140 D3010.50-LOD-400 Fuel Storage Tanks</i></p>

D3020 – Heating Systems

100	See D30	
200	Schematic layout with approximate size, shape, and location of element(s); approximate access/code clearance requirements modeled; shaft requirements modeled; design performance parameters as defined in the BIMXP to be associated with model elements as non-graphic information.	

D3020.10 – Heat Generation

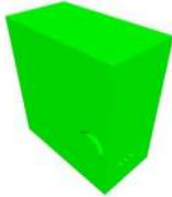
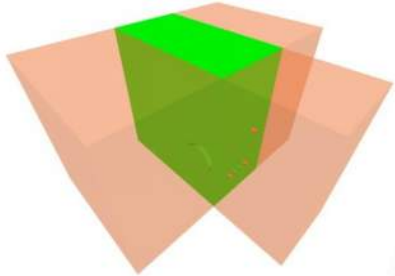
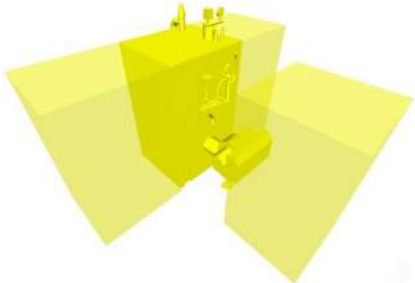
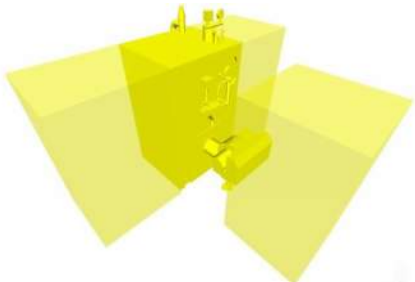
100	See D30	
200	See D3020	 <p><i>141 D3020.10-LOD-200 Heat Generation</i></p>
300	<p>Modeled as design-specified size, shape, spacing, and location of equipment;</p> <p>approximate allowances for spacing and clearances required for all specified anchors, supports, vibration and seismic control that are utilized in the layout of equipment;</p> <p>actual access/code clearance requirements modeled.</p>	 <p><i>142 D3020.10-LOD-300 Heat Generation</i></p>
350	<p>Modeled as actual size, shape, spacing, and location/connections of equipment,</p> <p>actual size, shape, spacing, and clearances required for all specified anchors, supports, vibration and seismic control that are utilized in the layout of equipment.</p>	 <p><i>143 D3020.10-LOD-350 Heat Generation</i></p>
400	<p>Supplementary components added to the model required for fabrication and field installation.</p>	 <p><i>144 D3020.10-LOD-400 Heat Generation</i></p>

D3020.30 – Thermal Heat Storage

[See [D3020.10](#)]

D3020.70 – Decentralized Heating Equipment

[See [D3020.10](#)]

D3020.90 – Heating System Supplementary Components

Includes expansion fittings, meters, gages, valves, hangers, supports, heat tracing, vibration and seismic controls.

These components are typically modeled as part of other assemblies listed in the tables above. Do not assign this Unifomat classification unless a supplementary component is modeled independently of another assembly.

D3030 – Cooling Systems

100	See D30	
200	Schematic layout with approximate size, shape, and location of element(s); approximate access/code clearance requirements modeled; shaft requirements modeled; design performance parameters as defined in the BIMXP to be associated with model elements as non-graphic information.	

D3030.10 – Central Cooling

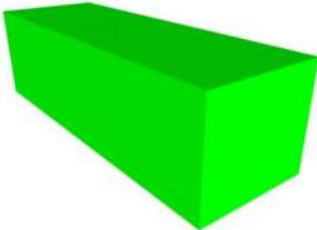
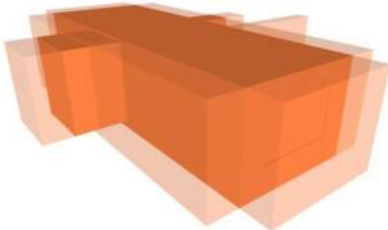
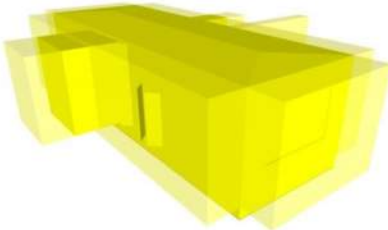
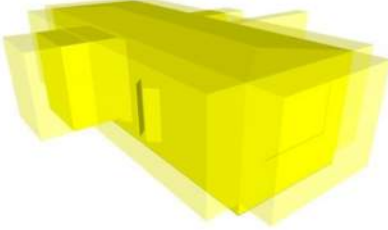
100	See D30	
200	See D3030	 <p data-bbox="959 596 1386 625"><i>145 D3030.10-LOD-200 Central Cooling</i></p>
300	<p data-bbox="253 655 924 709">Modeled as design-specified size, shape, spacing, and location of equipment;</p> <p data-bbox="253 724 924 806">approximate allowances for spacing and clearances required for all specified anchors, supports, vibration and seismic control that are utilized in the layout of equipment;</p> <p data-bbox="253 821 818 850">actual access/code clearance requirements modeled.</p>	 <p data-bbox="959 953 1386 982"><i>146 D3030.10-LOD-300 Central Cooling</i></p>
350	<p data-bbox="253 1012 924 1066">Modeled as actual size, shape, spacing, and location/connections of equipment;</p> <p data-bbox="253 1081 924 1163">actual size, shape, spacing, and clearances required for all specified anchors, supports, vibration and seismic control that are utilized in the layout of equipment.</p>	 <p data-bbox="959 1310 1386 1339"><i>147 D3030.10-LOD-350 Central Cooling</i></p>
400	<p data-bbox="253 1369 924 1423">Supplementary components added to the model required for fabrication and field installation.</p>	 <p data-bbox="959 1667 1386 1696"><i>148 D3030.10-LOD-400 Central Cooling</i></p>

D3030.30 – Evaporative Air-Cooling

100	See D3030.10	
200	See D3030.10	 <i>149 D3030.30-LOD-200 Evaporative Air-Cooling</i>
300	See D3030.10	 <i>150 D3030.30-LOD-300 Evaporative Air-Cooling</i>
350	See D3030.10	 <i>151 D3030.30-LOD-350 Evaporative Air-Cooling</i>
400	See D3030.10	 <i>152 D3030.30-LOD-400 Evaporative Air-Cooling</i>

D3030.50 – Thermal Cooling Storage

[See [D3030.10](#)]

D3030.70 – Decentralized Cooling

[See [D3030.10](#)]

D3030.90 – Cooling System Supplementary Components



Includes expansion fittings, meters, gages, valves, hangers, supports, heat tracing, vibration and seismic controls.

These components are typically modeled as part of other assemblies listed in the tables above. Do not assign this Uniformat classification unless a supplementary component is modeled independently of another assembly.

D3050 – Facility HVAC Distribution Systems

100	See D30	
200	Schematic layout with approximate size, shape, and location of element(s); approximate access/code clearance requirements modeled; shaft requirements modeled; design performance parameters as defined in the BIMXP to be associated with model elements as non-graphic information.	

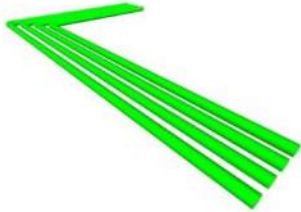
D3050.10 – Facility Hydronic Distribution

100	See D30	
200	See D3050	 <p><i>153D3050.10-LOD-200 Facility Hydronic Distribution</i></p>
300	<p>Modeled as design-specified size, shape, spacing, location, and slope of pipe, valves, fittings, and insulation for risers, mains, and branches;</p> <p>approximate allowances for spacing and clearances required for all specified hangers, supports, vibration and seismic control that are to be utilized in the layout of all risers, mains, and branches;</p> <p>actual access/code clearance requirements modeled.</p>	 <p><i>154D3050.10-LOD-300 Facility Hydronic Distribution</i></p>
350	<p>Modeled as actual size, shape, spacing, location, connections, and slope of pipe, valves, fittings, and insulation for risers, mains, and branches;</p> <p>actual size, shape, spacing, and clearances required for all hangers, supports, vibration and seismic control that are utilized in the layout of all risers, mains, and branches;</p> <p>actual floor and wall penetrations modeled.</p>	 <p><i>155D3050.10-LOD-350 Facility Hydronic Distribution</i></p>

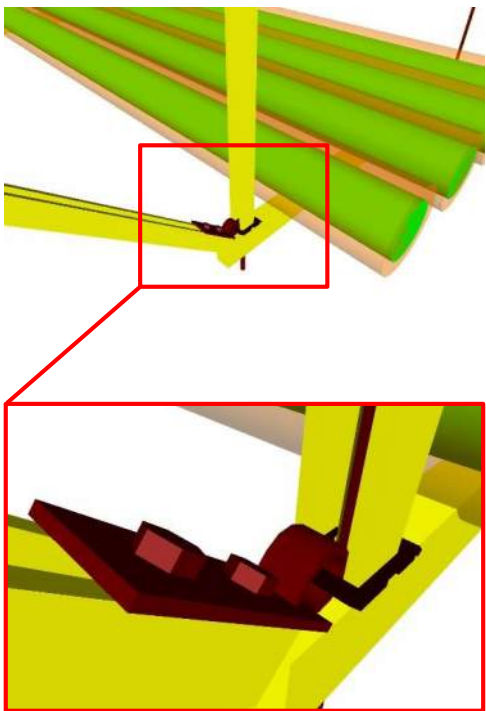
400	Supplementary components added to the model required for fabrication and field installation.	 <p data-bbox="971 951 1409 1003"><i>156 D3050.10-LOD-400 Facility Hydronic Distribution</i></p>
-----	--	---

D3050.30 – Facility Steam Distribution

[See [D3050.10](#)]

D3050.50 – HVAC Air Distribution

100	See D30	
200	See D3050	
300	Modeled as design-specified size, shape, spacing, and location of duct, dampers, fittings, and insulation for risers, mains, and branches; approximate allowances for spacing and clearances required for all specified hangers, supports, vibration and seismic control that are to be utilized in the layout of all risers, mains, and branches; actual access/code clearance requirements modeled.	
350	Modeled as actual size, shape, spacing, and location/connections of duct, dampers, fittings, and insulation for risers, mains, and branches; actual size, shape, spacing, and clearances required for all hangers, supports, vibration and seismic control that are utilized in the layout of all risers, mains, and branches; actual floor and wall penetrations modeled.	
400	See D3050.10	

D3050.90 – Facility Distribution Systems Supplementary Components

Includes expansion fittings, meters, gages, valves, hangers, supports, heat tracing, vibration and seismic controls.

These components are typically modeled as part of other assemblies listed in the tables above. Do not assign this Uniformat classification unless a supplementary component is modeled independently of another assembly.

D3060 – Ventilation

100	See D30	
200	Schematic layout with approximate size, shape, and location of mains and risers; shaft requirements modeled; design performance parameters as defined in the BIMXP to be associated with model elements as non-graphic information.	

D3060.10 – Supply Air

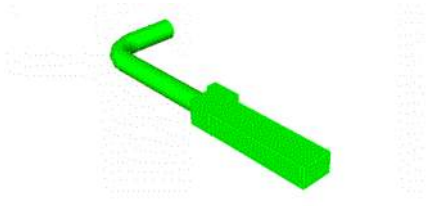
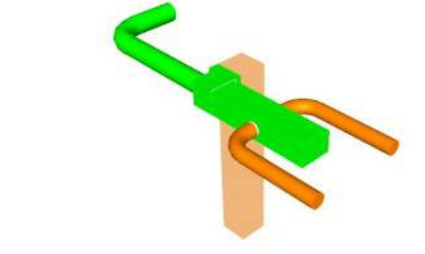
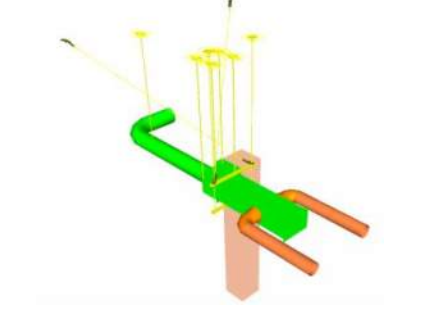
100	See D30	
200	See D3060	 <p data-bbox="972 600 1341 632"><i>157 D3060.10-LOD-200 Supply Air</i></p>
300	<p data-bbox="253 659 927 737">Modeled as design-specified size, shape, spacing, and location of duct, dampers, fittings, and insulation for risers, mains, and branches;</p> <p data-bbox="253 758 922 863">approximate specified allowances for spacing and clearances required for all hangers, supports, vibration and seismic control that are to be utilized in the layout of all risers, mains, and branches;</p> <p data-bbox="253 884 821 905">actual access/code clearance requirements modeled.</p>	 <p data-bbox="972 982 1341 1014"><i>158 D3060.10-LOD-300 Supply Air</i></p>
350	<p data-bbox="253 1037 935 1115">Modeled as actual size, shape, spacing, and location/connections of duct, dampers, fittings, and insulation for risers, mains, and branches;</p> <p data-bbox="253 1136 930 1220">actual size, shape, spacing, and clearances required for all hangers, supports, vibration and seismic control that are utilized in the layout of all risers, mains, and branches;</p> <p data-bbox="253 1241 711 1262">actual floor and wall penetrations modeled.</p>	 <p data-bbox="972 1423 1341 1455"><i>159 D3060.10-LOD-350 Supply Air</i></p>

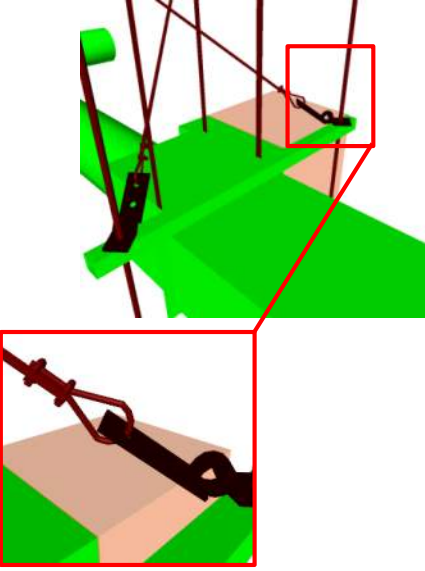
400	Supplementary components added to the model required for fabrication and field installation.	 <p><i>160D3060.10-LOD-400 Supply Air</i></p>
-----	--	---

D3060.20 – Return Air

[See [D3060.10](#)]

D3060.30 – Exhaust Air

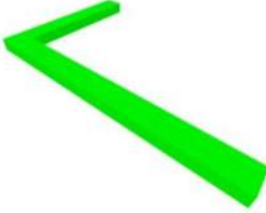
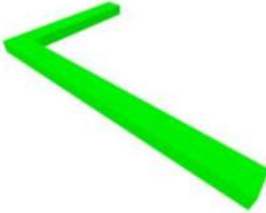
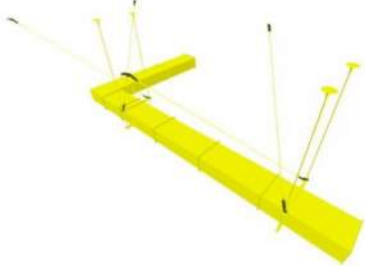
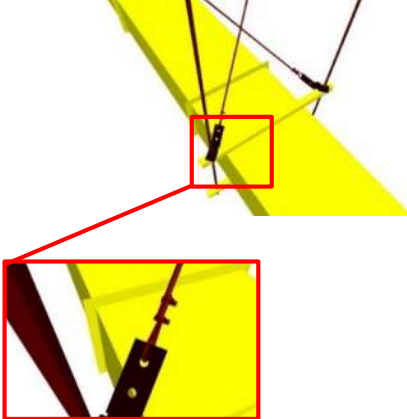
100	See D30	
200	See D3060	 <p data-bbox="1049 594 1430 621"><i>161 D3060.30-LOD-200 Exhaust Air</i></p>
300	<p>Modeled as design-specified size, shape, spacing, location, duct slope (if required), dampers, fittings, insulation for risers, mains, and branches;</p> <p>approximate specified allowances for spacing and clearances required for all hangers, supports, vibration and seismic control that are to be utilized in the layout of all risers, mains, and branches;</p> <p>actual access/code clearance requirements modeled.</p>	 <p data-bbox="1049 938 1430 966"><i>162 D3060.30-LOD-300 Exhaust Air</i></p>
350	<p>Modeled as actual size, shape, spacing, location, and slope(if required)/connections of duct, dampers, fittings, and insulation for risers, mains, and branches;</p> <p>actual size, shape, spacing, and clearances required for all hangers, supports, vibration and seismic control that are utilized in the layout of all risers, mains, and branches;</p> <p>actual floor and wall penetrations modeled.</p>	 <p data-bbox="1049 1333 1430 1360"><i>163 D3060.30-LOD-350 Exhaust Air</i></p>
400	See D3060.10	 <p data-bbox="1049 1818 1430 1845"><i>164 D3060.30-LOD-400 Exhaust Air</i></p>

D3060.40 – Outside Air

[See [D3060.10](#)]

D3060.60 – Air-to-Air Energy Recovery

[See [D3060.10](#)]

D3060.70 – HVAC Air Cleaning

[See [D3060.10](#)]

D3060.90 – Ventilation Supplementary Components

Includes expansion fittings, meters, gages, valves, hangers, supports, heat tracing, vibration and seismic controls.

These components are typically modeled as part of other assemblies listed in the tables above. Do not assign this Uniformat classification unless a supplementary component is modeled independently of another assembly.

D3070 – Special Purpose HVAC Systems

100	See D30	
200	Schematic layout with approximate size, shape, and location of components; design performance parameters as defined in the BIMXP to be associated with model elements as non-graphic information.	

D3070.10 – Snow Melting

100	See D30	
200	See D3070	
300	Modeled as design-specified size, shape, spacing, and location of supplementary components; approximate allowances for spacing and clearances required for all specified hangers, supports, vibration and seismic control that are to be utilized in the layout of all supplementary components; actual access/code clearance requirements modeled.	
350	Modeled as actual size, shape, spacing, and location/connections of supplementary components; actual size, shape, spacing, and clearances required for all hangers, supports, vibration and seismic control that are utilized in the layout of all supplementary components.	
400	Supplementary components added to the model required for fabrication and field installation.	

D40 Fire Protection



100	Diagrammatic or schematic model elements; conceptual and/or schematic layout/flow diagram; design performance parameters as defined in the BIMXP to be associated with model elements as non-graphic information.	
-----	---	--

D4010 – Fire Suppression

100	See D40	
200	Schematic layout with approximate size, shape, and location of mains and risers; approximate access/code clearance requirements modeled;	

	shaft requirements modeled; design performance parameters as defined in the BIMXP to be associated with model elements as non-graphic information.	
--	---	--

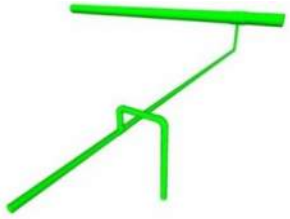
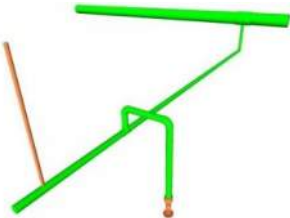
D4010.10 – Water-Based Fire-Suppression

100	See D40	
200	See D4010	 <p data-bbox="992 533 1446 590"><i>165D4010.10-LOD-200 Water-Based Fire-Suppression</i></p>
300	<p data-bbox="240 617 964 695">Modeled as design-specified size, shape, spacing, and location of pipe/slope(if required)/valves/fittings/insulation for risers, mains, and branches/standpipes;</p> <p data-bbox="240 716 954 821">approximate allowances for spacing and clearances required for all specified hangers, supports, vibration and seismic control that are to be utilized in the layout of all risers, mains, and branches/standpipes;</p> <p data-bbox="240 842 808 863">actual access/code clearance requirements modeled.</p>	 <p data-bbox="992 884 1446 940"><i>166D4010.10-LOD-300 Water-Based Fire-Suppression</i></p>
350	<p data-bbox="240 968 911 1045">Modeled as actual size, shape, spacing, and location/ slope(if required)/connections of pipe, valves, fittings, and insulation for risers, mains, and branches/standpipes;</p> <p data-bbox="240 1066 943 1144">actual size, shape, spacing, and clearances required for all hangers, supports, vibration and seismic control that are utilized in the layout of all risers, mains, and branches/standpipes;</p> <p data-bbox="240 1165 699 1186">actual floor and wall penetrations modeled.</p>	 <p data-bbox="992 1297 1446 1354"><i>167D4010.10-LOD-350 Water-Based Fire-Suppression</i></p>
400	Supplementary components added to the model required for fabrication and field installation.	 <p data-bbox="992 1711 1446 1768"><i>168 D4010.10-LOD-400 Water-Based Fire-Suppression</i></p>

D4010.50 – Fire-Extinguishing

[See [D4010.10](#)]

D4010.90 – Fire Suppression Supplementary Components

Includes expansion fittings, meters, gages, valves, hangers, supports, heat tracing, vibration and seismic controls.

These components are typically modeled as part of other assemblies listed in the tables above. Do not assign this Unifomat classification unless a supplementary component is modeled independently of another assembly.

D4030 – Fire Protection Specialties

100	See D40	
200	Schematic layout with approximate size, shape, and location of components; design performance parameters as defined in the BIMXP to be associated with model elements as non-graphic information.	

D4030.10 – Fire Protection Cabinets

100	See D40	
200	See D4030	
300	Modeled as design-specified size, shape, spacing, and location of components; approximate allowances for spacing and clearances required for all specified hangers, supports, vibration and seismic control that are to be utilized in the layout of all components; actual access/code clearance requirements modeled.	
350	Modeled as actual size, shape, spacing, and location/connections of components; actual size, shape, spacing, and clearances required for all hangers, supports, vibration and seismic control that are utilized in the layout of all components.	
400	Supplementary components added to the model required for fabrication and field installation.	

D4030.30 – Fire Extinguishers

[See [D4030.10](#)]

D4030.50 – Breathing Air Replenishment Systems

[See [D4030.10](#)]

D4030.70 – Fire Extinguisher Accessories

[See [D4030.10](#)]

D50 Electrical

100	Diagrammatic or schematic model elements: conceptual and/or schematic layout; design performance parameters as defined in the BIMXP to be associated with model elements as non-graphic information.	
-----	--	--

D5010 – Facility Power Generation

100	See D50	
200	Schematic layout with approximate size, shape, and location of equipment; approximate access/code clearance requirements modeled; design performance parameters as defined in the BIMXP to be associated with model elements as non-graphic information.	

D5010.10 – Packaged Generator Assemblies

Description: Generator, frequency changers, and rotary converters and uninterruptible power units.

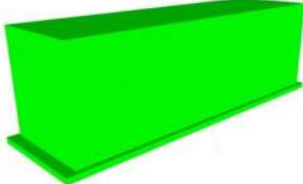
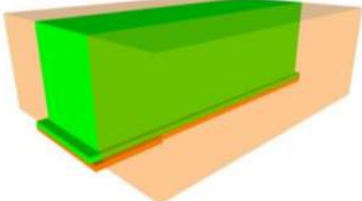
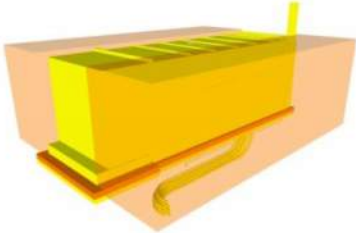
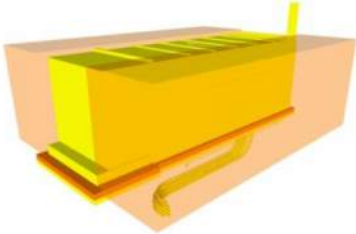
100	See D50	
200	See D5010	 <p><i>169 D5010.10-LOD-200 Packaged Generator Assemblies</i></p>
300	<p>Modeled as design-specified size, shape, spacing, and location of equipment and associated components;</p> <p>approximate allowances for spacing and clearances required for all specified supports and seismic control;</p> <p>actual access/code clearance requirements modeled.</p>	 <p><i>170 D5010.10-LOD-300 Packaged Generator Assemblies</i></p>
350	<p>Modeled as actual size, shape, spacing, and location of equipment and associated components;</p> <p>actual size, shape, spacing, and location for supports and seismic control;</p> <p>actual size, shape, and location/connections of equipment and support structure/pads.</p>	 <p><i>171 D5010.10-LOD-350 Packaged Generator Assemblies</i></p>
400	<p>Supplementary components added to the model required for fabrication and field installation.</p>	 <p><i>172 D5010.10-LOD-400 Packaged Generator Assemblies</i></p>

D5010.20 – Battery Equipment

Description: Batteries, battery racks, battery chargers, static power converters, uninterruptible power supplies, and accessories.

[See [D5010.10](#)]

D5010.30 – Photovoltaic Collectors

Description: Solar cells to convert sunlight to electricity.

[See [D5010.10](#)]

D5010.40 – Fuel Cells

Description: Fuel cell electricity generating equipment.

[See [D5010.10](#)]

D5010.70 – Transfer Switches

Description: Switches that transfer from one source of electricity to another.

[See [D5010.10](#)]

D5020 – Electrical Service and Distribution

100	See D50	
200	Schematic layout with approximate size, shape, and location of equipment; approximate access/code clearance requirements modeled; design performance parameters as defined in the BIMXP to be associated with model elements as non-graphic information.	

D5020.10 – Electrical Service Entrance

Description: Meters, substations, transformers, switchgear, switchboards, and protective devices where electrical power enters structure.

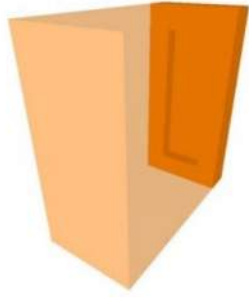
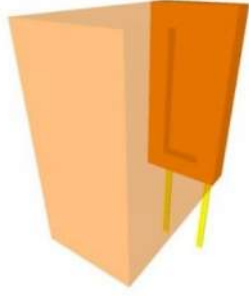
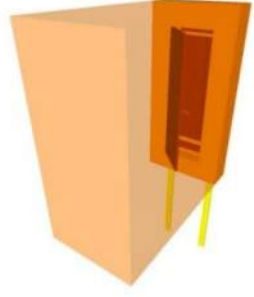
100	See D50	
200	See D5020	
300	<p>Modeled as design-specified size, shape, spacing, and location of equipment and associated components;</p> <p>approximate allowances for spacing and clearances required for all specified supports and seismic control;</p> <p>actual access/code clearance requirements modeled.</p>	 <p><i>173 D5020.10-LOD-300 Electrical Service Entrance</i></p>
350	<p>Modeled as actual size, shape, spacing, and location of equipment and associated components;</p> <p>actual size, shape, spacing, and location for supports and seismic control;</p> <p>actual size, shape, and location/connections of equipment and support structure/pads.</p>	 <p><i>174 D5020.10-LOD-350 Electrical Service Entrance</i></p>
400	<p>Supplementary components added to the model required for fabrication and field installation.</p>	 <p><i>175 D5020.10-LOD-400 Electrical Service Entrance</i></p>

D5020.30 – Power Distribution

Description: Bus assemblies, distribution equipment, and electrical wiring system to distribute electrical power to switchboards, panelboards, and motor control centers.

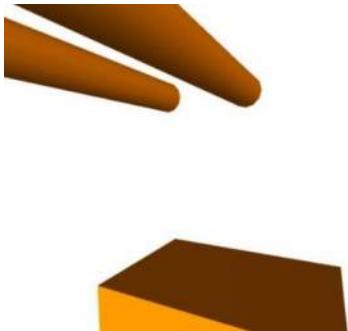
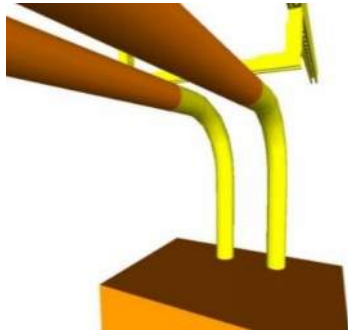
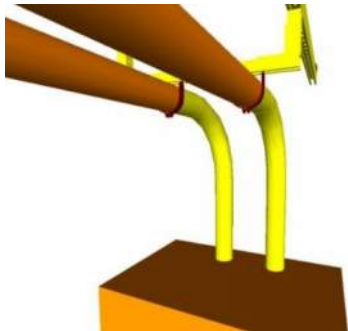
100	See D50	
200	See D5020	
300	<p>Modeled as design-specified size, shape, spacing, and location of raceways, boxes, enclosures, and equipment; approximate allowances for spacing and clearances required for all specified hangers, supports and seismic control; actual access/code clearance requirements modeled.</p>	 <p>176 D5020.30-LOD-300 Power Distribution</p>
350	<p>Modeled as actual size, shape, spacing, and location of raceways, boxes, and enclosures; actual size, shape, spacing, and location for supports and seismic control; actual size, shape, and location/connections of equipment and support structure/pads; actual floor and wall penetrations are modeled.</p>	 <p>177 D5020.30-LOD-350 Power Distribution</p>
400	<p>Supplementary components added to the model required for fabrication and field installation.</p>	 <p>178 D5020.30-LOD-400 Power Distribution</p>

D5020.70 – Facility Grounding

Description: Raceways, wiring and devices for grounding and bonding an electrical distribution system.

100	See D50	
200	See D5020	
300	Modeled as design-specified size, shape, spacing, and location of raceways, boxes, enclosures, and the electrical equipment and end-devices served; approximate allowances for spacing and clearances required for all specified hangers, supports, and seismic control; actual access/code clearance requirements modeled.	
350	Modeled as actual size, shape, spacing, and location of raceways, boxes, enclosures, and the electrical equipment and end-devices served; actual size, shape, spacing, and location for supports and seismic control; actual floor and wall penetrations are modeled.	
400	Supplementary components added to the model required for fabrication and field installation.	

D5030 – General Purpose Electrical Power

100	See D50	
200	Schematic layout with approximate size, shape, and location of equipment; approximate access/code clearance requirements modeled; design performance parameters as defined in the BIMXP to be associated with model elements as non-graphic information.	

D5030.10 – Branch Wiring System

Description: Raceways, ducts, cable trays, and wiring to deliver power from branch panelboards to the point of use.

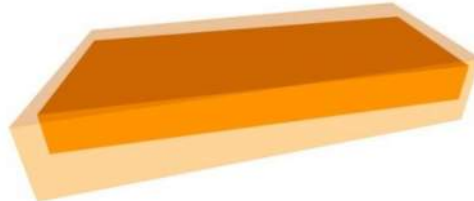
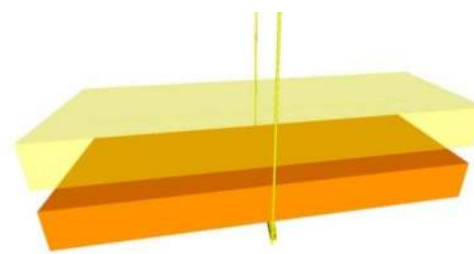
100	See D50	
200	See D5030	
300	Modeled as design-specified size, shape, spacing, and location of raceways, boxes, and enclosures; approximate allowances for spacing and clearances required for all specified hangers, supports and seismic control; actual access/code clearance requirements modeled.	 <p><i>179 D5030.10-LOD-300 Branch Wiring System</i></p>
350	Modeled as actual size, shape, spacing, and location of raceways, boxes, enclosures; actual size, shape, spacing, and location for supports and seismic control; actual floor and wall penetrations are modeled.	 <p><i>180 D5030.10-LOD-350 Branch Wiring System</i></p>
400	Supplementary components added to the model required for fabrication and field installation.	

D5030.50 – Wiring Devices

Description: Electrical devices at point of use including electrical outlets and switches.

100	See D50	
200	See D5030	
300	Modeled as design-specified size, shape, spacing, and location of outlet boxes and devices; actual access/code clearance requirements modeled.	
350	Modeled as actual size, shape, spacing, and location of outlet boxes and devices.	
400	Supplementary components added to the model required for fabrication and field installation.	

D5040 – Lighting

100	See D50	
200	Schematic layout with approximate size, shape, and location of equipment; approximate access/code clearance requirements modeled;	

	design performance parameters as defined in the BIMXP to be associated with model elements as non-graphic information.	
--	--	--

D5040.10 – Lighting Control

Description: Clock and calendar, photoelectric switches, occupancy sensors, and light-leveling control devices.

100	See D50	
200	See D5040	
300	Modeled as design-specified size, shape, spacing, and location of enclosures, equipment, and devices; actual access/code clearance requirements modeled.	
350	Modeled as actual size, shape, spacing, and location of enclosures, equipment, and control devices; actual size, shape, and location/connections of equipment and control devices.	
400	Supplementary components added to the model required for fabrication and field installation.	

D5040.20 – Branch Wiring for Lighting

Description: Raceways, ducts, trays, and wiring beyond branch circuit panelboards to lighting fixtures.

100	See D50	
200	See D5040	
300	Modeled as design-specified size, shape, spacing, and location of raceways, boxes, and enclosures to fixture locations; approximate allowances for spacing and clearances required for all specified hangers, supports, and seismic control.	
350	Modeled as actual size, shape, spacing, and location of raceways, boxes, and enclosures to fixture locations; actual size, shape, spacing, and location for supports and seismic control; actual floor and wall penetrations are modeled.	
400	Supplementary components added to the model required for fabrication and field installation.	

D5040.50 – Lighting Fixtures

Description: Luminaires, lighting equipment, ballasts, and accessories. Includes fluorescent, high intensity discharge, incandescent, mercury vapor, neon, and sodium vapor lighting.

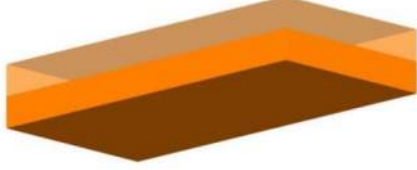
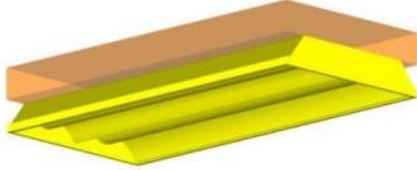
100	See D50	
200	See D5040	
300	Modeled as design-specified size, shape, spacing, and location of lighting fixtures; approximate allowances for spacing and clearances required for all specified hangers, supports and seismic control; actual access/code clearance requirements modeled.	 <p>181 D5040.50-LOD-300 Lighting Fixtures</p>
350	Modeled as actual size, shape, spacing, and location of lighting fixtures. actual size, shape, spacing, and location for supports and seismic control.	 <p>182 D5040.50-LOD-350 Lighting Fixtures</p>
400	Supplementary components added to the model required for fabrication and field installation.	

D5080 – Miscellaneous Electrical Systems

100	See D50	
200	Schematic layout with approximate size, shape, and location of equipment; approximate access/code clearance requirements modeled; design performance parameters as defined in the BIMXP to be associated with model elements as non-graphic information.	

D5080.10 – Lightning Protection

Description: Wiring and equipment for lightning protection.

100	See D50	
200	See D5080	
300	<p>Modeled as design-specified size, shape, spacing, and location of raceways, boxes, enclosures including the electrical equipment and end-devices served;</p> <p>approximate allowances for spacing and clearances required for all specified hangers, supports and seismic control;</p> <p>actual access/code clearance requirements modeled.</p>	
350	<p>Modeled as actual size, shape, spacing, and location of raceways, boxes, enclosures including the electrical equipment, fixtures, and end-devices served</p> <p>actual size, shape, spacing, and location for supports and seismic control;</p> <p>actual size, shape, and location/connections of equipment and support structure/pads;</p> <p>actual floor and wall penetrations are modeled.</p>	
400	Supplementary components added to the model required for fabrication and field installation.	

D5080.70 – Transient Voltage Suppression

Description: Devices to protect against voltage surges on electrical distribution systems.

100	See D50	
200	See D5080	
300	Modeled as design-specified size, shape, spacing, and location of equipment; approximate allowances for spacing and clearances required for all specified hangers, supports and seismic control; actual access/code clearance requirements modeled.	
350	Modeled as actual size, shape, spacing, and location of the equipment; actual size, shape, spacing, and location for supports and seismic control.	
400	Supplementary components added to the model required for fabrication and field installation.	

D60 Communications

[See [Fundamental LOD Definitions](#)]

D6010 – Data Communications

[See [Fundamental LOD Definitions](#)]

D6020 – Voice Communications

[See [Fundamental LOD Definitions](#)]

D6030 – Audio-Video Communication

[See [Fundamental LOD Definitions](#)]

D6060 – Distributed Communications and Monitoring

[See [Fundamental LOD Definitions](#)]

D6090 – Communications Supplementary Components

[See [Fundamental LOD Definitions](#)]

D70 Electronic Safety and Security

[See [Fundamental LOD Definitions](#)]

D7010 – Access Control and Intrusion Detection

[See [Fundamental LOD Definitions](#)]

D7030 – Electronic Surveillance

[See [Fundamental LOD Definitions](#)]

D7050 – Detection and Alarm

[See [Fundamental LOD Definitions](#)]

D7070 – Electronic Monitoring and Control

[See [Fundamental LOD Definitions](#)]

D7090 – Electronic Safety and Security Supplementary Components

These components are typically modeled as part of other assemblies listed in the tables above. Do not assign this Unifomat classification unless a supplementary component is modeled independently of another assembly.

D80 Integrated Automation

[See [Fundamental LOD Definitions](#)]

D8010 – Integrated Automation Facility Controls

[See [Fundamental LOD Definitions](#)]

E: EQUIPMENT & FURNISHINGS

E10 Equipment

100	Diagrammatic or schematic model elements: conceptual and/or schematic layout; design performance parameters as defined in the BIMXP to be associated with model elements as non-graphic information.	
-----	--	--

E1010 – Vehicle and Pedestrian Equipment

100	See E10	
200	Schematic layout with approximate size, shape, and location of equipment; approximate access/code clearance requirements modeled; design performance parameters as defined in the BIMXP to be associated with model elements as non-graphic information.	

E1010.10 – Vehicle Servicing Equipment

100	See E10	
200	See E1010	
300	Modeled as design-specified size, shape, spacing, and location of equipment and associated components; approximate allowances for spacing and clearances required for all specified supports and seismic control; actual access/code clearance requirements modeled.	
350	Modeled as actual size, shape, spacing, and location of equipment and associated components; actual size, shape, spacing, and location for supports and seismic control; actual size, shape, and location/connections of equipment and support structure/pads.	
400	Supplementary components added to the model required for fabrication and field installation.	

E1010.30 – Interior Parking Control Equipment

[See [E1010.10](#)]

E1010.50 – Loading Dock Equipment

[See [E1010.10](#)]

E1010.70 – Interior Pedestrian Control Equipment

[See [E1010.10](#)]

E1030 – Commercial Equipment

[See [E1010](#)]

E1030.10 – Mercantile and Service Equipment

[See [E1010.10](#)]

E1030.20 – Vault Equipment

[See [E1010.10](#)]

E1030.25 – Teller and Service Equipment

[See [E1010.10](#)]

E1030.30 – Refrigerated Display Equipment

[See [E1010.10](#)]

E1030.35 – Commercial Laundry and Dry Cleaning Equipment

[See [E1010.10](#)]

E1030.40 – Maintenance Equipment

[See [E1010.10](#)]

E1030.50 – Hospitality Equipment

[See [E1010.10](#)]

E1030.55 – Unit Kitchens

[See [E1010.10](#)]

E1030.60 – Photographic Processing Equipment

[See [E1010.10](#)]

E1030.70 – Postal, Packaging and Shipping Equipment

[See [E1010.10](#)]

E1030.75 – Office Equipment

[See [E1010.10](#)]

E1030.80 – Foodservice Equipment

[See [E1010.10](#)]

E1040 – Institutional Equipment

[See [E1010](#)]

E1040.10 – Educational and Scientific Equipment

[See [E1010.10](#)]

E1040.20 – Healthcare Equipment

[See [E1010.10](#)]

E1040.40 – Religious Equipment

[See [E1010.10](#)]

E1040.60 – Security Equipment

[See [E1010.10](#)]

E1040.70 – Detention Equipment

[See [E1010.10](#)]

E1060 – Residential Equipment

[See [E1010](#)]

E1060.10 – Residential Appliances

[See [E1010.10](#)]

E1060.50 – Residential Stairs

[See [B1080](#)]

E1060.70 – Residential Ceiling Fans

[See [E1010.10](#)]

E1070 – Entertainment and Recreational Equipment

[See [E1010](#)]

E1070.10 – Theater and Stage Equipment

[See [E1010.10](#)]

E1070.20 – Musical Equipment

[See [E1010.10](#)]

E1070.50 – Athletic Equipment

[See [E1010.10](#)]

E1070.60 – Recreational Equipment

[See [E1010.10](#)]

E1090 – Other Equipment

[See [E1010](#)]

E1090.10 – Solid Waste Handling Equipment

[See [E1010.10](#)]

E1090.30 – Agricultural Equipment

[See [E1010.10](#)]

E1090.40 – Horticultural Equipment

[See [E1010.10](#)]

E1090.60 – Decontamination Equipment

[See [E1010.10](#)]

E20 Furnishings

100	<p>A schematic model element or symbol that is not distinguishable by type or material.</p> <p>Types, layouts, and locations are still flexible.</p>	
-----	--	--

E2010 – Fixed Furnishings

100	See E20	
200	<p>Generic model elements with approximate nominal size.</p> <p>Placement and quantity remains flexible.</p> <p>Required non-graphic information associated with model elements includes included with element:</p> <ul style="list-style-type: none"> • Type of object 	

E2010.10 – Fixed Art

100	See E20	
200	See E2010	
300	Modeled types with specific dimensions, locations, and quantities.	
350	<p>Include any applicable service or installation clearances.</p> <p>Include any applicable support or connection points.</p>	
400	Supplementary components added to the model required for fabrication and field installation.	

E2010.20 – Window Treatments

[See [E2010.10](#)]

E2010.30 – Casework

[See [E2010.10](#)]

E2010.70 – Fixed Multiple Seating

[See [E2010.10](#)]

E2010.90 – Other Fixed Furnishings

[See [E2010.10](#)]

E2050 – Movable Furnishings

[See [E2010](#)]

E2050.10 – Movable Art

[See [E2010.10](#)]

E2050.30 – Furniture

[See [E2010.10](#)]

E2050.40 – Accessories

[See [E2010.10](#)]

E2050.60 – Movable Multiple Seating

[See [E2010.10](#)]

E2050.90 – Other Movable Furnishings

[See [E2010.10](#)]

F: SPECIAL CONSTRUCTION & DEMOLITION

F10 Special Construction

F1010 – Integrated Construction

[See [Fundamental LOD Definitions](#)]

F1020 – Special Structures

[See [Fundamental LOD Definitions](#)]

F1030 – Special Function Construction

[See [Fundamental LOD Definitions](#)]

F1050 – Special Facility Components

[See [Fundamental LOD Definitions](#)]

F1060 – Athletic and Recreational Special Construction

[See [Fundamental LOD Definitions](#)]

F1080 – Special Instrumentation

[See [Fundamental LOD Definitions](#)]

F20 Facility Remediation

F2010 – Hazardous Materials Remediation

[See [Fundamental LOD Definitions](#)]

F30 Demolition

F3010 – Structure Demolition

[See [Fundamental LOD Definitions](#)]

F3030 – Selective Demolition

[See [Fundamental LOD Definitions](#)]

F3050 – Structure Moving

[See [Fundamental LOD Definitions](#)]

G: BUILDING SITEWORK

G10 Site Preparation

100	A simple topographic surface is provided.	 <p><i>183 G10-LOD-100 Site Preparation</i></p>
200	Element modeling to include: <ul style="list-style-type: none">• Approximate size and shape of foundation element• Approximate size/location of utilities and structures• Approximate code and clearance requirements• Approximate pipe material• Rough modeling of site grading	

G1010 – Site Clearing

G1020 – Site Elements Demolition

G1030 – Site Element Relocations

G1050 – Site Remediation

G1070 – Site Earthwork

G1070.10 – Grading

100	<p>Existing Surface: 3D surface generated from site topography, with grade breaks and lines as needed to define accurate surface. 3D site features included if provided by surveyor (i.e. walls, signage, stairs, etc., as defined in Survey LOC-Grade)</p> <p>Proposed Surface: Generic Surface Interpolation between the following elements: Building Envelope at Finish Floor, Finish Grade at Retaining Walls, Grading Limits</p> <p>Local Coordinate Control. Shared Coordinate from Building Grid base point to real-world project control</p>	
200	<p>Existing Surface: Added definition from supplemental survey, revised limits of work</p> <p>Proposed Surface: Added definition including curbs, hardscape, finish surface at building envelopes (to correspond to stem walls/deepened footings).</p>	
300	<p>Existing Surface: Added definition from supplemental survey, revised limits of work</p> <p>Proposed Surface: Complete and accurate surface definition based on defined fine grading, grade breaks, curbs, hardscape, buildings, swales, etc.</p>	

G20 Site Improvements

100	Diagrammatic or schematic model elements.	
200	<p>Element modeling to include:</p> <ul style="list-style-type: none"> • Approximate size and shape of foundation element • Approximate size/location of utilities and structures • Approximate code and clearance requirements • Approximate pipe material • Rough modeling of site grading • Local structural building grids defined in model and coordinated with global state plane coordinate system for site model. 	

G2010 – Roadways

[See [Fundamental LOD Definitions](#)]

G2020 – Parking Lots

[See [Fundamental LOD Definitions](#)]

G2020.10 – Parking Lot Pavement

100	See G20	
200	See G20	
300	Specific thickness of pavement and substrate modeled. All drainage slopes modeled.	
350	Openings for drains and other services modeled.	

G2020.20 – Parking Lot Curbs and Gutters

100	See G20	
200	See G20	
300	Full extents of curbs and gutters (above and below grade) are modeled.	
350	Element modeling to include: <ul style="list-style-type: none">• Reinforcing• Pour stops• Expansion joints	

G2020.40 – Parking Lot Appurtenances

Includes traffic signals, signage, striping.

[See [Fundamental LOD Definitions](#)]

G2030 – Pedestrian Plazas and Walkways

G2040 – Airfields

G2050 – Athletic, Recreational, and Playfield Areas

G2060 – Site Development

[See [Fundamental LOD Definitions](#)]

G2080 – Landscaping

[See [Fundamental LOD Definitions](#)]

G30 Liquid and Gas Site Utilities

100	Horizontal Pipe Alignment, assumed elevation and sizing	
-----	---	--

G3010 – Water Utilities

100	See G30	
-----	-------------------------	--

G3010.10 – Site Domestic Water Distribution

100	See G30	
200	Added materials, sizes, vertical control and appurtenances (valves, hydrants, BFP, FDC, PIV, BOV, ARV)	

G3010.30 – Site Fire Protection Water Distribution

100	See G30	
200	Added materials, sizes, vertical control and appurtenances (valves, hydrants, BFP, FDC, PIV, BOV, ARV)	

G3020 – Sanitary Sewerage Utilities

100	See G30	
-----	-------------------------	--

G3020.20 – Sanitary Sewerage Piping

100	See G30	
200	Horizontal alignment, elevations and sizing, generic materials	
300	Specific elevations, sizes, materials	

G3020.50 – Sanitary Sewerage Structures

100	See G30	
200	Added specific structure types, sizes and materials approximate, all locations	
300	Added specific structure elements at all locations, specific sizes and materials	

G3030 – Storm Drainage Utilities

100	See G30	
-----	-------------------------	--

G3050 – Site Energy Distribution

100	See G30	
-----	-------------------------	--

G3060 – Site Fuel Distribution

100	See G30	
-----	-------------------------	--

G3090 – Liquid and Gas Site Utilities Supplementary Components

These components are typically modeled as part of other assemblies listed in the tables above. Do not assign this Unifomat classification unless a supplementary component is modeled independently of another assembly.

G40 Electrical Site Improvements

100	Diagrammatic or schematic model elements: conceptual and/or schematic layout; design performance parameters as defined in the BIMXP to be associated with model elements as non-graphic information.	
-----	--	--

G4010 – Site Electric Distribution Systems

Description: Electrical wiring systems to distribute electrical power to on the Site. Includes Duct Banks, Pullboxes, vaults and transformers from the utility point of connection, to the building's main electric room.

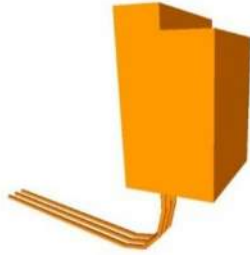
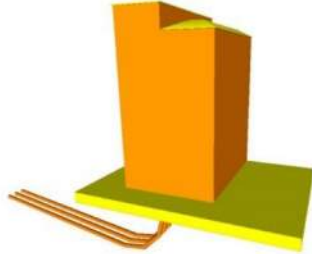
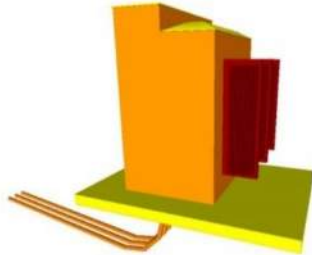
100	See G40	
200	Generic model elements in schematic layout with: approximate size, shape, and location of equipment; approximate access/code clearance requirements modeled; design performance parameters as defined in the BIMXP to be associated with model elements as non-graphic information.	
300	Modeled as design-specified size, shape, spacing, and location of raceways/ boxes/enclosures/duct banks in the power distribution system specified size, shape, spacing, and location of equipment and associated components; approximate allowances for spacing and clearances required for all specified hangers, supports and seismic control access/code clearance requirements modeled	 <p><i>184 G4010-LOD-300 Site Electric Distribution Systems</i></p>
350	Modeled as actual size, shape, spacing, and location of raceways/ boxes/enclosures/duct banks in the power distribution system; actual size, shape, spacing, and location for supports and seismic control; actual size, shape, and location/connections of equipment and support structure/pads.	 <p><i>185 G4010-LOD-350 Site Electric Distribution Systems</i></p>
400	Supplementary components added to the model required for fabrication and field installation.	 <p><i>186 G4010-LOD-400 Site Electric Distribution Systems</i></p>

G4050 – Site Lighting

Description: Luminaires, lighting equipment, ballasts, and accessories. Includes fluorescent, high intensity discharge, incandescent, mercury vapor, neon, and sodium vapor lighting. Includes Pole Mount, Building Mount and on-grade fixtures for exterior lighting.

100	See G40	
200	Generic elements in schematic layout with: approximate size, shape, and location of equipment; approximate access/code clearance requirements modeled; design performance parameters as defined in the BIMXP to be associated with model elements as non-graphic information.	
300	Modeled as design-specified size, shape, spacing, and location of lighting fixtures; approximate allowances for spacing and clearances required for all specified hangers, supports and seismic control; required pole bases and footing elements; access/code clearance requirements modeled.	
350	Modeled as actual size, shape, spacing, and location of lighting fixtures; actual size, shape, spacing, and location for supports and seismic control; actual size, shape, and location/connections of equipment and support structure/pads.	
400	Supplementary components added to the model required for fabrication and field installation.	

G50 Site Communications

100	<p>Diagrammatic or schematic model elements: conceptual and/or schematic layout; design performance parameters as defined in the BIMXP to be associated with model elements as non-graphic information.</p>	
-----	---	--

G5010 – Site Communications Systems

Description: Conduit Systems for routing of Communication trunk systems.

100	See G50	
200	<p>Generic elements in a schematic layout with: approximate size, shape, and location of equipment; approximate access/code clearance requirements modeled; design performance parameters as defined in the BIMXP to be associated with model elements as non-graphic information.</p>	
300	<p>Modeled as design-specified size, shape, spacing, and location of raceways, boxes, and enclosures in the power distribution system; size, shape, spacing, and location of equipment and associated components; approximate allowances for spacing and clearances required for all specified hangers, supports and seismic control; access/code clearance requirements modeled.</p>	
350	<p>Modeled as actual size, shape, spacing, and location of raceways, boxes, and enclosures in the power distribution system; size, shape, spacing, and location for supports and seismic control; size, shape, location, and connections of equipment and support structure or pads; floor and wall penetrations are modeled.</p>	
400	Supplementary components added to the model required for fabrication and field installation.	

G90 Miscellaneous Site Construction

G9010 – Tunnels

[See [Fundamental LOD Definitions](#)]

Graphics Index

Figure 1	15
Figure 2	16
Figure 3	16
Figure 4	17
5 A1010.10-LOD-200 Wall Foundation	19
6 A1010.10-LOD-300 Wall Foundation	19
7 A1010.10-LOD-350 Wall Foundations (Shallow Foundations)	20
8 A1010.30-LOD-300 Column Foundations (Deep Foundations)	21
9 A1010.30-LOD-350 Column Foundations	21
10 A1010.30-LOD-400 Column Foundations	22
11 A1020.80-LOD-200 Grade Beams	24
12 A1020.80-LOD-300 Grade Beams	24
13 A1020.80-LOD-350 Grade Beams	25
14 A40-LOD-200 Slabs-on-Grade	27
15 A4010-LOD-300 Standard Slabs-on-Grade.....	27
16 A4010-LOD-350 Standard Slabs-on-Grade.....	27
17 A4020-LOD-300 Structural Slabs-on-Grade.....	29
18 A4020-LOD-350 Structural Slabs-on-Grade.....	29
19 B1010.10-LOD-100 Floor Structural Frame (Steel Framing Columns)	33
20 B1010.10-LOD-200 Floor Structural Frame (Steel Framing Columns)	33
21 B1010.10-LOD-300 Floor Structural Frame (Steel Framing Columns)	33
22 B1010.10-LOD-350 Floor Structural Frame (Steel Framing Columns)	33
23 B1010.10-LOD-400 Floor Structural Frame (Steel Framing Columns)	34
24 B1010.10-LOD-300 Floor Structural Frame (Steel Framing Beams)	35
25 B1010.10-LOD-350 Floor Structural Frame (Steel Framing Beams)	35
26 B1010.10-LOD-400 Floor Structural Frame (Steel Framing Beams)	35
27 B1010.100-LOD-300 Floor Structural Frame (Steel Framing Bracing Rods).....	37
28 B1010.100-LOD-350 Floor Structural Frame (Steel Framing Bracing Rods).....	37
29 B1010.100-LOD-400 Floor Structural Frame (Steel Framing Bracing Rods).....	37
30 B1010.10-LOD-200 Floor Structural Frame (Steel Joists)	38
31 B1010.10-LOD-300 Floor Structural Frame (Steel Joists)	38
32 B1010.10-LOD-350 Floor Structural Frame (Steel Joists)	38
33 B1010.10-LOD-400 Floor Structural Frame (Steel Joists)	39
34 B1010.10-LOD-200 Floor Structural Frame (Masonry Framing)	41
35 B1010.10-LOD-300 Floor Structural Frame (Masonry Framing)	41
36 B1010.10-LOD-350 Floor Structural Frame (Masonry Framing)	41
37 B1010.10-LOD-400 Floor Structural Frame (Masonry Framing)	42
38 B1010.10-LOD-200 Floor Structural Frame (Wood Floor Trusses)	43
39 B1010.10-LOD-300 Floor Structural Frame (Wood Floor Trusses)	43
40 B1010.10-LOD-350 Floor Structural Frame (Wood Floor Trusses)	43
41 B1010.10-LOD-400 Floor Structural Frame (Wood Floor Trusses)	44
42 B1080.10-LOD-200 Stair Construction	50
43 B1080.10-LOD-300 Stair Construction	50
44 B1080.10-LOD-350 Stair Construction	51
45 B1080.10-LOD-400 Stair Construction	51
46 B1080.50-LOD-200 Stair Railings	52
47 B1080.50-LOD-300 Stair Railings	52
48 B1080.50-LOD-400 Stair Railings	52
49 B2010-LOD-200 Exterior Walls	54
50 B2010-LOD-300 Exterior Walls	54
51 B2010-LOD-350 Exterior Walls	54
52 B2010.04-LOD-200 Exterior Wall (Masonry)	55
53 B2010.04-LOD-300 Exterior Wall (Masonry)	55
54 B2010.04-LOD-350 Exterior Wall (Masonry)	55
55 B2010.04-LOD-400 Exterior Wall (Masonry)	56
56 B2010.05-LOD-200 Exterior Wall (Cold-Form Metal Framing)	57
57 B2010.05-LOD-300 Exterior Wall (Cold-Form Metal Framing)	57
58 B2010.05-LOD-350 Exterior Wall (Cold-Form Metal Framing)	58
59 B2010.05-LOD-400 Exterior Wall (Cold-Form Metal Framing)	58

60 B2010.06-LOD-200 Exterior Wall (Wood)	59
61 B2010.06-LOD-300 Exterior Wall (Wood)	59
62 B2010.06-LOD-350 Exterior Wall (Wood)	60
63 B2010.06-LOD-400 Exterior Wall (Wood)	60
64 B2010.10-LOD-100 Exterior Wall Veneer	61
65 B2010.10-LOD-200 Exterior Wall Veneer	61
66 B2010.10-LOD-300 Exterior Wall Veneer	61
67 B2010.10-LOD-350 Exterior Wall Veneer	61
68 B2010.10-LOD-400 Exterior Wall Veneer	62
69 B2010.20-LOD-350 Exterior Wall Construction	63
70 B2010.30-LOD-350 Exterior Wall Interior Skin	63
71 B2020.30-LOD-200 Exterior Window Wall	66
72 B2020.30-LOD-300 Exterior Window Wall	66
73 B2020.30-LOD-350 Exterior Window Wall	67
74 B2020.30-LOD-400 Exterior Window Wall	68
75 C1010.04-LOD-200 Interior Wall (Masonry)	77
76 C1010.04-LOD-300 Interior Wall (Masonry)	77
77 C1010.04-LOD-350 Interior Wall (Masonry)	77
78 C1010.04-LOD-400 Interior Wall (Masonry)	78
79 C1010.05-LOD-200 Interior Wall (Cold-Form Metal Framing)	79
80 C1010.05-LOD-300 Interior Wall (Cold-Form Metal Framing)	79
81 C1010.05-LOD-350 Interior Wall (Cold-Form Metal Framing)	80
82 C1010.05-LOD-400 Interior Wall (Cold-Form Metal Framing)	81
83 C1010.06-LOD-200 Interior Wall (Wood)	82
84 C1010.06-LOD-300 Interior Wall (Wood)	82
85 C1010.06-LOD-350 Interior Wall (Wood)	83
86 C1010.06-LOD-400 Interior Wall (Wood)	83
87 D1050.70-LOD-100 Pneumatic Tube Systems	99
88 D1050.70-LOD-200 Pneumatic Tube Systems	99
89 D1050.70-LOD-300 Pneumatic Tube Systems	99
90 D1050.70-LOD-350 Pneumatic Tube Systems	99
91 D1050.70-LOD-400 Pneumatic Tube Systems	100
92 D2010.10-LOD-200 Facility Potable-Water Storage Tanks	102
93 D2010.10-LOD-300 Facility Potable-Water Storage Tanks	102
94 D2010.10-LOD-350 Facility Potable-Water Storage Tanks	102
95 D2010.10-LOD-400 Facility Potable-Water Storage Tanks	102
96 D2010.20-LOD-100 Domestic Water Equipment	103
97 D2010.20-LOD-200 Domestic Water Equipment	103
98 D2010.20-LOD-300 Domestic Water Equipment	103
99 D2010.20-LOD-350 Domestic Water Equipment	103
100 D2010.20-LOD-400 Domestic Water Equipment	103
101 D2010.40-LOD-200 Domestic Water Piping	104
102 D2010.40-LOD-300 Domestic Water Piping	104
103 D2010.40-LOD-350 Domestic Water Piping	104
104 D2010.40-LOD-400 Domestic Water Piping	104
105 D2010.60-LOD-200 Plumbing Fixtures	105
106 D2010.60-LOD-200 Plumbing Fixtures	105
107 D2010.60-LOD-350 Plumbing Fixtures	105
108 D2010.60-LOD-400 Plumbing Fixtures	105
109 D2020.10-LOD-200 Sanitary Sewerage Equipment	107
110 D2020.10-LOD-300 Sanitary Sewerage Equipment	107
111 D2020.10-LOD-350 Sanitary Sewerage Equipment	107
112 D2020.10-LOD-400 Sanitary Sewerage Equipment	107
113 D2020.30-LOD-200 Sanitary Sewerage Piping	108
114 D2020.30-LOD-300 Sanitary Sewerage Piping	108
115 D2020.30-LOD-350 Sanitary Sewerage Piping	108
116 D2020.30-LOD-400 Sanitary Sewerage Piping	108
117 D2030.10-LOD-200 Stormwater Drainage Equipment	110
118 D2030.10-LOD-300 Stormwater Drainage Equipment	110
119 D2030.10-LOD-350 Stormwater Drainage Equipment	110
120 D2030.10-LOD-400 Stormwater Drainage Equipment	110
121 D2030.20-LOD-200 Stormwater Drainage Piping	111
122 D2030.20-LOD-300 Stormwater Drainage Piping	111
123 D2030.20-LOD-350 Stormwater Drainage Piping	111

124	D2030.20-LOD-400 Stormwater Drainage Piping	112
125	D2030.30-LOD-200 Facility Stormwater Drains	113
126	D2030.30-LOD-300 Facility Stormwater Drains	113
127	D2030.30-LOD-350 Facility Stormwater Drains	113
128	D2030.30-LOD-400 Facility Stormwater Drains	113
129	D2060.10-LOD-200 Compressed-Air Systems.....	115
130	D2060.10-LOD-300 Compressed-Air Systems.....	115
131	D2060.10-LOD-350 Compressed-Air Systems.....	115
132	D2060.10-LOD-400 Compressed-Air Systems.....	115
133	D3010.10-200 Fuel Piping.....	118
134	D3010.10-300 Fuel Piping.....	118
135	D3010.10-350 Fuel Piping.....	118
136	D3010.10-400 Fuel Piping.....	119
137	D3010.50-LOD-200 Fuel Storage Tanks	121
138	D3010.50-LOD-300 Fuel Storage Tanks	121
139	D3010.50-LOD-350 Fuel Storage Tanks	121
140	D3010.50-LOD-400 Fuel Storage Tanks	121
141	D3020.10-LOD-200 Heat Generation.....	123
142	D3020.10-LOD-300 Heat Generation.....	123
143	D3020.10-LOD-350 Heat Generation.....	123
144	D3020.10-LOD-400 Heat Generation.....	123
145	D3030.10-LOD-200 Central Cooling	126
146	D3030.10-LOD-300 Central Cooling	126
147	D3030.10-LOD-350 Central Cooling	126
148	D3030.10-LOD-400 Central Cooling	126
149	D3030.30-LOD-200 Evaporative Air-Cooling.....	127
150	D3030.30-LOD-300 Evaporative Air-Cooling.....	127
151	D3030.30-LOD-350 Evaporative Air-Cooling.....	127
152	D3030.30-LOD-400 Evaporative Air-Cooling.....	127
153	D3050.10-LOD-200 Facility Hydronic Distribution	129
154	D3050.10-LOD-300 Facility Hydronic Distribution	129
155	D3050.10-LOD-350 Facility Hydronic Distribution	129
156	D3050.10-LOD-400 Facility Hydronic Distribution	130
157	D3060.10-LOD-200 Supply Air.....	132
158	D3060.10-LOD-300 Supply Air.....	132
159	D3060.10-LOD-350 Supply Air.....	132
160	D3060.10-LOD-400 Supply Air.....	133
161	D3060.30-LOD-200 Exhaust Air.....	134
162	D3060.30-LOD-300 Exhaust Air.....	134
163	D3060.30-LOD-350 Exhaust Air.....	134
164	D3060.30-LOD-400 Exhaust Air.....	134
165	D4010.10-LOD-200 Water-Based Fire-Suppression	137
166	D4010.10-LOD-300 Water-Based Fire-Suppression	137
167	D4010.10-LOD-350 Water-Based Fire-Suppression	137
168	D4010.10-LOD-400 Water-Based Fire-Suppression	137
169	D5010.10-LOD-200 Packaged Generator Assemblies.....	140
170	D5010.10-LOD-300 Packaged Generator Assemblies.....	140
171	D5010.10-LOD-350 Packaged Generator Assemblies.....	140
172	D5010.10-LOD-400 Packaged Generator Assemblies.....	140
173	D5020.10-LOD-300 Electrical Service Entrance	142
174	D5020.10-LOD-350 Electrical Service Entrance	142
175	D5020.10-LOD-400 Electrical Service Entrance	142
176	D5020.30-LOD-300 Power Distribution	143
177	D5020.30-LOD-350 Power Distribution	143
178	D5020.30-LOD-400 Power Distribution	143
179	D5030.10-LOD-300 Branch Wiring System.....	145
180	D5030.10-LOD-350 Branch Wiring System.....	145
181	D5040.50-LOD-300 Lighting Fixtures.....	147
182	D5040.50-LOD-350 Lighting Fixtures.....	147
183	G10-LOD-100 Site Preparation	157
184	G4010-LOD-300 Site Electric Distribution Systems.....	162

185 G4010-LOD-350 Site Electric Distribution Systems..... 162
186 G4010-LOD-400 Site Electric Distribution Systems..... 162

Appendix

The appendix section contains content that is developed in collaboration with industry organizations, leading expert practitioners, and feedback from committees following the issue of the April 2015 Draft. They are being released in the Appendix of this edition of the LOD Specification for public comment and use. They are proposed for the main body of the next submission of the LOD Specification. The following elements shall be modeled in accordance with these additional pages when the LOD Specification is used.

B1010.10 – Precast Structural Inverted T Beam (Concrete)

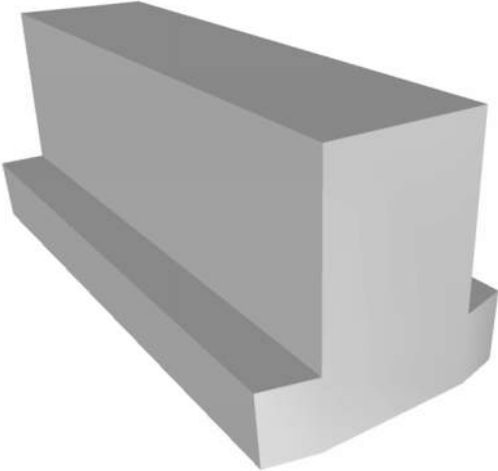
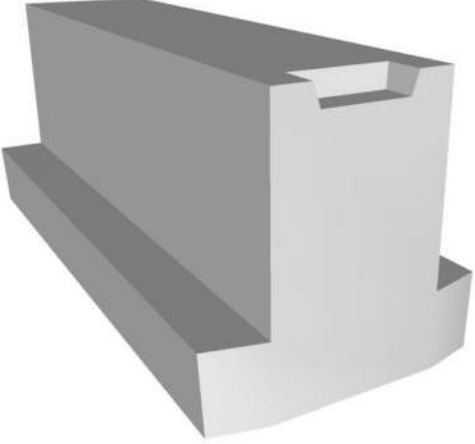
100	See B10	
200	<p>Element modeling to include:</p> <ul style="list-style-type: none"> • Type of structural concrete system • Approximate geometry (e.g. depth) of structural elements 	 <p><i>B1010.10-LOD 200 Precast Structural Inverted T Beam (Concrete)</i></p>
300	<p>Element modeling to include:</p> <ul style="list-style-type: none"> • Specific sizes and locations of main concrete structural members modeled per defined structural grid with correct orientation • Concrete defined per spec (strength, air entrainment, aggregate size, etc.) • All sloping surfaces included in model element with exception of elements affected by manufacturer selection <p>Required non-graphic information associated with model elements includes:</p> <ul style="list-style-type: none"> • Penetrations for items such as MEP • Finishes, camber, chamfers, etc. • Typical details • Embeds and anchor rods • Aggregate, clear cover • Reinforcing spacing • Reinforcing • Live loads 	 <p><i>B1010.10-LOD 300 Precast Structural Inverted T Beam (Concrete)</i></p>

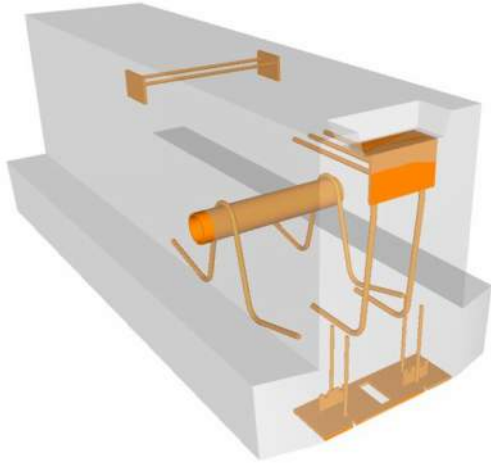
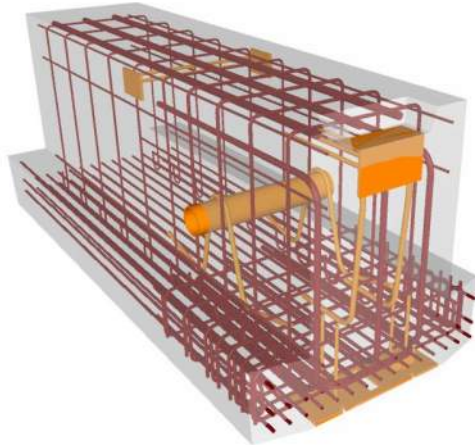
350	<p>Element modeling to include:</p> <ul style="list-style-type: none">• Reinforcing Post-tension profiles and strand locations• Reinforcement called out, modeled if required by the BIMXP, typically only in congested areas• Pour joints and sequences to help identify reinforcing lap splice locations, scheduling, etc.• Lifting devices• Expansion Joints• Embeds and anchor rods• Post-tension profile and strands modeled if required by the BIMXP• Penetrations for items such as MEP• Any permanent forming or shoring components	 <p><i>B1010.10-LOD 350 Precast Structural Inverted T Beam (Concrete)</i></p>
400	<p>Element modeling to include:</p> <ul style="list-style-type: none">• All reinforcement including post tension elements detailed and modeled• Finishes, camber, chamfer, etc.	 <p><i>B1010.10-LOD 400 Precast Structural Inverted T Beam (Concrete)</i></p>

B1010.10 – Precast Structural Column (Concrete)

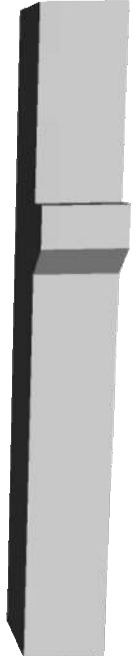
100	See B10	
200	<p>Element modeling to include:</p> <ul style="list-style-type: none"> • Type of structural concrete system • Approximate geometry (e.g. depth) of structural elements 	 <p><i>B1010.10 - LOD 200 Precast Structural Column (Concrete)</i></p>
300	<p>Element modeling to include:</p> <ul style="list-style-type: none"> • Specific sizes and locations of main concrete structural members modeled per defined structural grid with correct orientation • Concrete defined per spec (strength, air entrainment, aggregate size, etc.) • All sloping surfaces included in model element with exception of elements affected by manufacturer selection <p>Required non-graphic information associated with model elements includes:</p> <ul style="list-style-type: none"> • Penetrations for items such as MEP • Finishes, camber, chamfers, etc. • Typical details • Embeds and anchor rods • Aggregate, clear cover • Reinforcing spacing • Reinforcing • Live loads 	 <p><i>B1010.10 - LOD 300 Precast Structural Column (Concrete)</i></p>

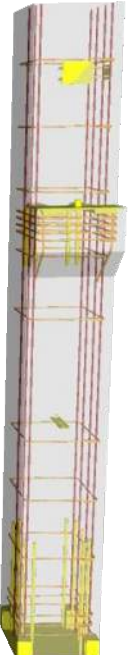
350	<p>Element modeling to include:</p> <ul style="list-style-type: none">• Reinforcing Post-tension profiles and strand locations• Reinforcement called out, modeled if required by the BIMXP, typically only in congested areas• Pour joints and sequences to help identify reinforcing lap splice locations, scheduling, etc.• Expansion Joints• Lifting devices• Embeds and anchor rods• Post-tension profile and strands modeled if required by the BIMXP• Penetrations for items such as MEP• Any permanent forming or shoring components	 <p><i>B1010.10 - LOD 350 Precast Structural Column (Concrete)</i></p>
400	<p>Element modeling to include:</p> <ul style="list-style-type: none">• All reinforcement including post tension elements detailed and modeled• Finishes, camber, chamfer, etc.	 <p><i>B1010.10 - LOD 400 Precast Structural Column (Concrete)</i></p>

B1010.10 – Precast Structural Double Tee (Concrete)

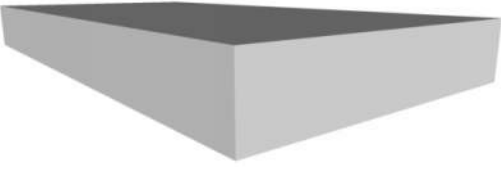
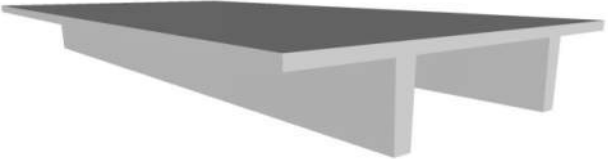
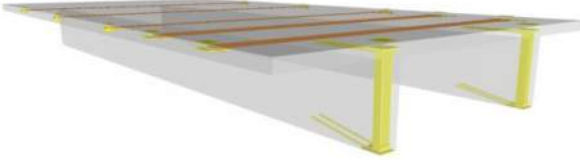
100	See B10	
200	<p>Element modeling to include:</p> <ul style="list-style-type: none"> Type of structural concrete system Approximate geometry (e.g. depth) of structural elements 	 <p><i>B1010.1 – LOD 200 Precast Structural Double Tee (Concrete)</i></p>
300	<p>Element modeling to include:</p> <ul style="list-style-type: none"> Specific sizes and locations of main concrete structural members modeled per defined structural grid with correct orientation Concrete defined per spec (strength, air entrainment, aggregate size, etc.) All sloping surfaces included in model element with exception of elements affected by manufacturer selection <p>Required non-graphic information associated with model elements includes:</p> <ul style="list-style-type: none"> Penetrations for items such as MEP Finishes, camber, chamfers, etc. Typical details Embeds and anchor rods Aggregate, clear cover Reinforcing spacing Reinforcing Live loads 	 <p><i>B1010.1 – LOD 300 Precast Structural Double Tee (Concrete)</i></p>
350	<p>Element modeling to include:</p> <ul style="list-style-type: none"> Reinforcing Post-tension profiles and strand locations Reinforcement called out, modeled if required by the BIMXP, typically only in congested areas Pour joints and sequences to help identify reinforcing lap splice locations, scheduling, etc. Expansion Joints Lifting devices Embeds and anchor rods Post-tension profile and strands modeled if required by the BIMXP Penetrations for items such as MEP Any permanent forming or shoring components 	 <p><i>B1010.1 – LOD 350 Precast Structural Double Tee (Concrete)</i></p>

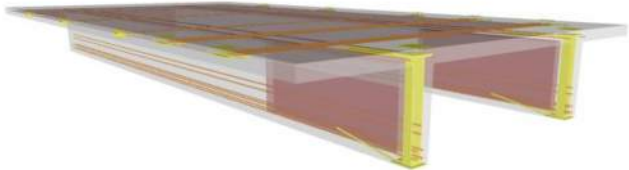
400	<p>Element modeling to include:</p> <ul style="list-style-type: none">• All reinforcement including post tension elements detailed and modeled• Finishes, camber, chamfer, etc.	 <p><i>B1010.1 – LOD 400 Precast Structural Double Tee (Concrete)</i></p>
-----	--	---

B1010.10 – Precast Wall (Concrete)

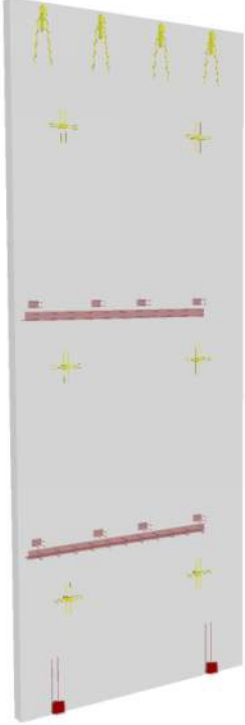
100	See B10	
200	<p>Element modeling to include:</p> <ul style="list-style-type: none"> Type of structural concrete system Approximate geometry (e.g. depth) of structural elements 	
300	<p>Element modeling to include:</p> <ul style="list-style-type: none"> Specific sizes and locations of main concrete structural members modeled per defined structural grid with correct orientation Concrete defined per spec (strength, air entrainment, aggregate size, etc.) All sloping surfaces included in model element with exception of elements affected by manufacturer selection <p>Required non-graphic information associated with model elements includes:</p> <ul style="list-style-type: none"> Penetrations for items such as MEP Finishes, camber, chamfers, etc. Typical details Embeds and anchor rods Aggregate, clear cover Reinforcing spacing Reinforcing Live loads 	
350	<p>Element modeling to include:</p> <ul style="list-style-type: none"> Reinforcing Post-tension profiles and strand locations Reinforcement called out, modeled if required by the BIMXP, typically only in congested areas Pour joints and sequences to help identify reinforcing lap splice locations, scheduling, etc. Expansion Joints Lifting devices Embeds and anchor rods Post-tension profile and strands modeled if required by the BIMXP Penetrations for items such as MEP Any permanent forming or shoring components 	 <p><i>B1010.10 – LOD 350 Precast Wall (Concrete)</i></p>

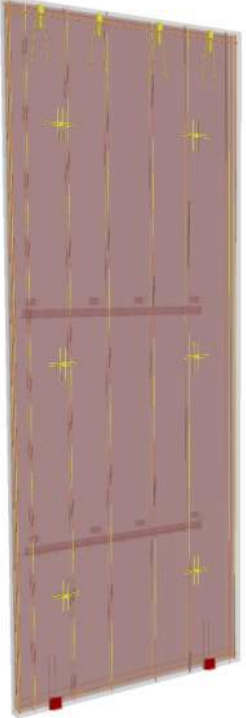
400	<p>Element modeling to include:</p> <ul style="list-style-type: none">• All reinforcement including post tension elements detailed and modeled• Finishes, camber, chamfer, etc.	 <p>B1010.10 – LOD 400 Precast Wall (Concrete)</p>
-----	--	---

B1010 – Highway Bridges Precast Structural I Girder (Concrete)

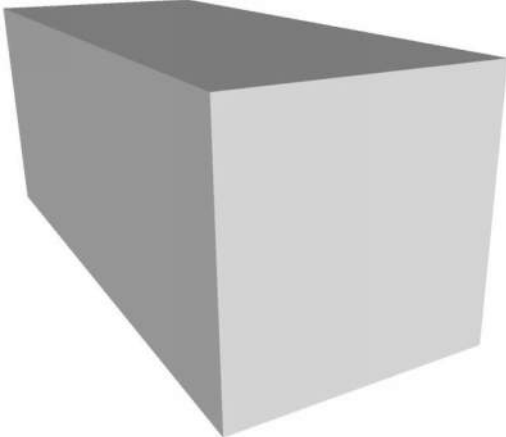
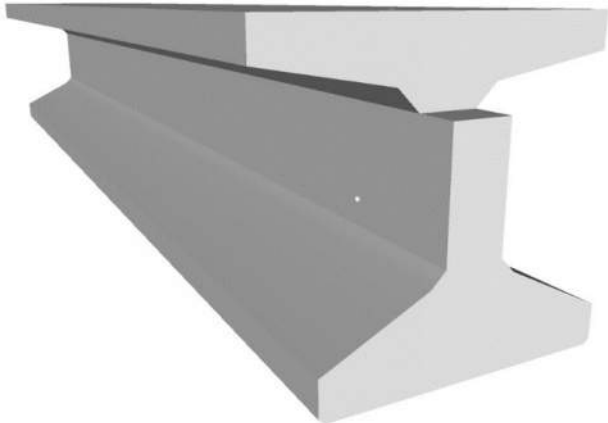
100	See B10	
200	<p>Element modeling to include:</p> <ul style="list-style-type: none"> Type of structural concrete system Approximate geometry (e.g. depth) of structural elements 	 <p><i>B1010 – LOD 200 Highway Bridges Precast Structural I Girder (Concrete)</i></p>
300	<p>Element modeling to include:</p> <ul style="list-style-type: none"> Specific sizes and locations of main concrete structural members modeled per defined structural grid with correct orientation Concrete defined per spec (strength, air entrainment, aggregate size, etc.) All sloping surfaces included in model element with exception of elements affected by manufacturer selection <p>Required non-graphic information associated with model elements includes:</p> <ul style="list-style-type: none"> Penetrations for items such as MEP Finishes, camber, chamfers, etc. Typical details Embeds and anchor rods Aggregate, clear cover Reinforcing spacing Reinforcing Live loads 	 <p><i>B1010 – LOD 300 Highway Bridges Precast Structural I Girder (Concrete)</i></p>

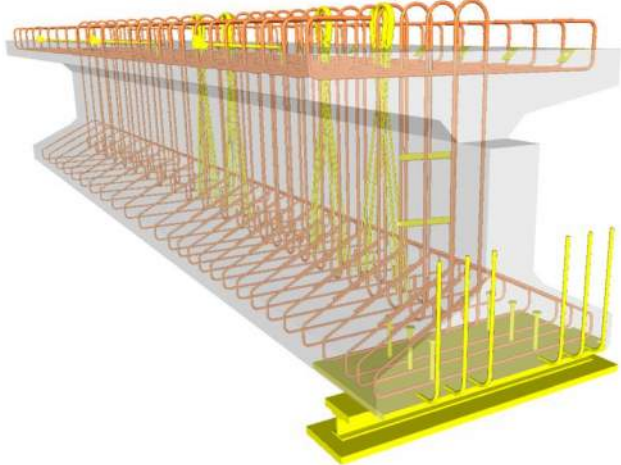
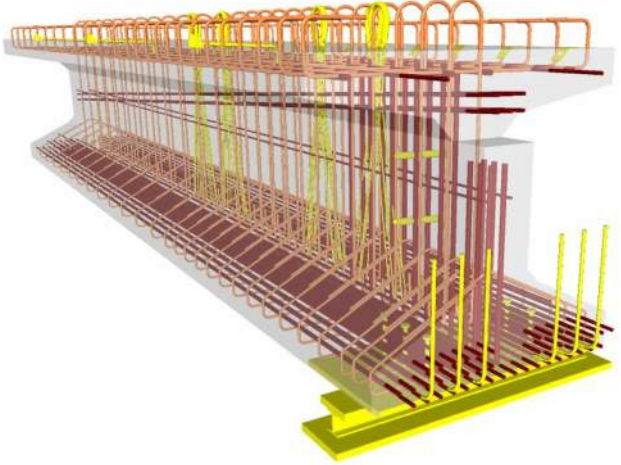
350	<p>Element modeling to include:</p> <ul style="list-style-type: none">• Reinforcing Post-tension profiles and strand locations• Reinforcement called out, modeled if required by the BIMXP, typically only in congested areas• Pour joints and sequences to help identify reinforcing lap splice locations, scheduling, etc.• Expansion Joints• Lifting devices• Embeds and anchor rods• Post-tension profile and strands modeled if required by the BIMXP• Penetrations for items such as MEP• Any permanent forming or shoring components	 <p><i>B1010 – LOD 350 Highway Bridges Precast Structural I Girder (Concrete)</i></p>
400	<p>Element modeling to include:</p> <ul style="list-style-type: none">• All reinforcement including post tension elements detailed and modeled• Finishes, camber, chamfer, etc.	 <p><i>B1010 – LOD 400 Highway Bridges Precast Structural I Girder (Concrete)</i></p>

B1010 - Highway Bridge Girder Steel

Classification is based off of NIST Proposed Uniformat II for Classification of Bridge Elements. A copy of this document can be found at <http://www.nist.gov>

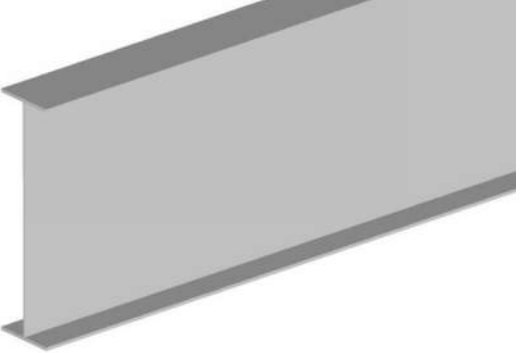
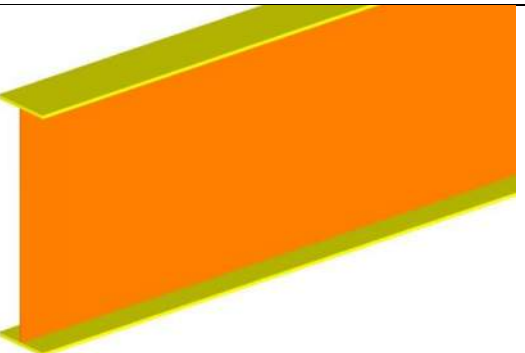
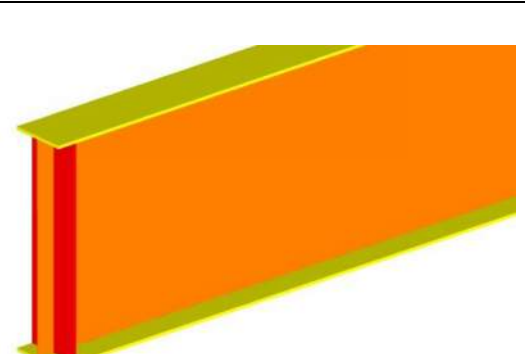
<p>200</p>	<p>Generic mass of Girder</p> <p>Other non-graphic information may be included such as:</p> <ul style="list-style-type: none"> • Girder Depth • Web Plate Length • Flange Plate Width 	 <p><i>B1010 – LOD 200 Highway Bridge Girder Steel</i></p>
<p>300</p>	<p>Required non-graphic information associated with model elements may include:</p> <ul style="list-style-type: none"> • Thickness of the Flange and Web Plate • Finishes, i.e. painted, galvanized, et 	 <p><i>B1010 – LOD 300 Highway Bridge Girder Steel</i></p>
<p>350</p>	<p>Element modeling to include:</p> <ul style="list-style-type: none"> • Stiffeners • Exact sloping of members • Splits between Plate Girders 	 <p><i>B1010 – LOD 350 Highway Bridge Girder Steel</i></p>

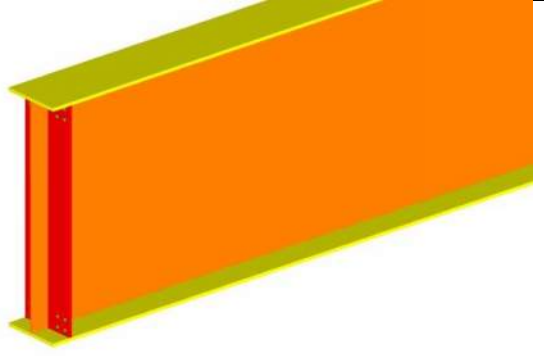
400	<p>Element modeling to include fabrication level information:</p> <ul style="list-style-type: none">• Welds• Coping of members• Washers, nuts, etc.• Grating, holes in grating• All assembly elements	 <p><i>B1010 – LOD 400 Highway Bridge Girder Steel</i></p>
-----	---	--

B1010 – Railroad Bridges Precast Structural I Girder (Concrete)

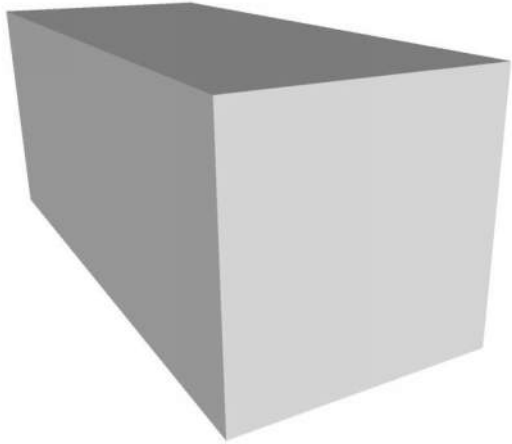
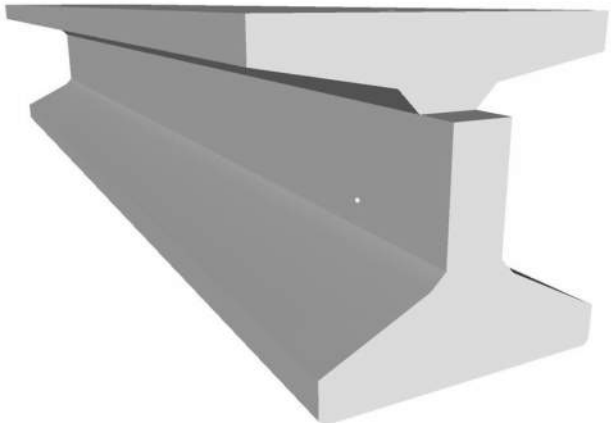
100	See B10	
200	<p>Element modeling to include:</p> <ul style="list-style-type: none"> • Type of structural concrete system • Approximate geometry (e.g. depth) of structural elements 	 <p><i>B1010 – LOD 200 Railroad Bridges Precast Structural I Girder (Concrete)</i></p>
300	<p>Element modeling to include:</p> <ul style="list-style-type: none"> • Specific sizes and locations of main concrete structural members modeled per defined structural grid with correct orientation • Concrete defined per spec (strength, air entrainment, aggregate size, etc.) • All sloping surfaces included in model element with exception of elements affected by manufacturer selection <p>Required non-graphic information associated with model elements includes:</p> <ul style="list-style-type: none"> • Penetrations for items such as MEP • Finishes, camber, chamfers, etc. • Typical details • Embeds and anchor rods • Aggregate, clear cover • Reinforcing spacing • Reinforcing • Live loads 	 <p><i>B1010 – LOD 300 Railroad Bridges Precast Structural I Girder (Concrete)</i></p>

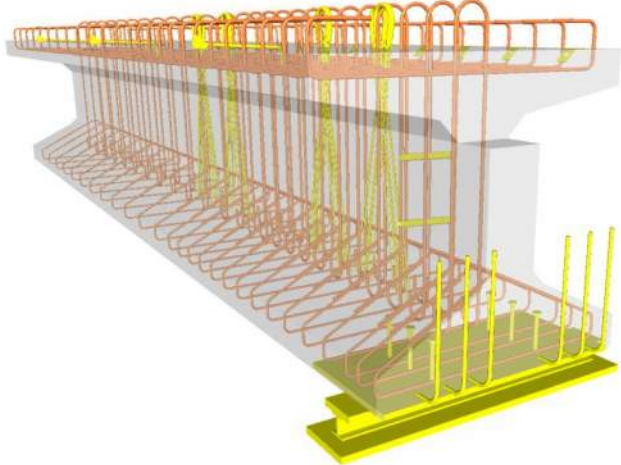
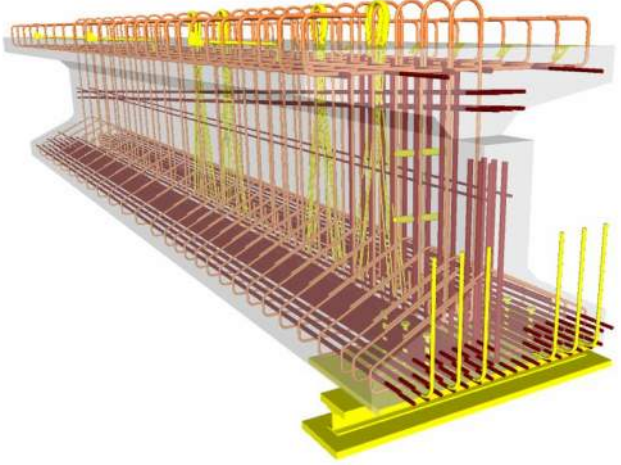
350	<p>Element modeling to include:</p> <ul style="list-style-type: none">• Reinforcing Post-tension profiles and strand locations• Reinforcement called out, modeled if required by the BIMXP, typically only in congested areas• Pour joints and sequences to help identify reinforcing lap splice locations, scheduling, etc.• Expansion Joints• Lifting devices• Embeds and anchor rods• Post-tension profile and strands modeled if required by the BIMXP• Penetrations for items such as MEP• Any permanent forming or shoring components	 <p><i>B1010 – LOD 350 Railroad Bridges Precast Structural I Girder (Concrete)</i></p>
400	<p>Element modeling to include:</p> <ul style="list-style-type: none">• All reinforcement including post tension elements detailed and modeled• Finishes, camber, chamfer, etc.	 <p><i>B1010 – LOD 400 Railroad Bridges Precast Structural I Girder (Concrete)</i></p>

B1010 - Railroad Bridge Girder Steel

Classification is based off of NIST Proposed Uniformat II for Classification of Bridge Elements. A copy of this document can be found at <http://www.nist.gov>

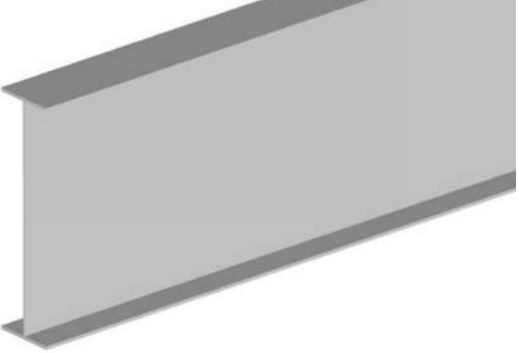
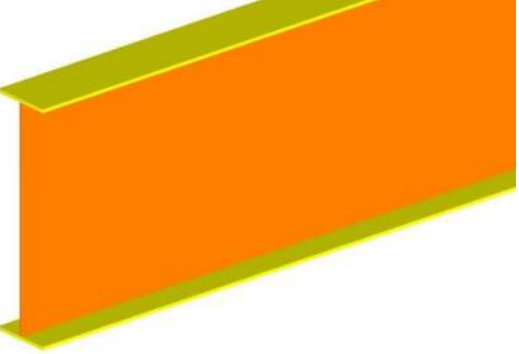
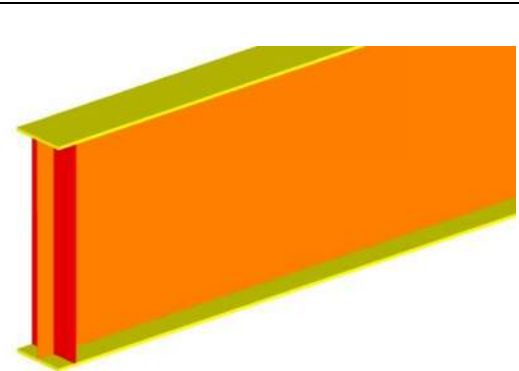
<p>200</p>	<p>Generic mass of Girder</p> <p>Other non-graphic information may be included such as:</p> <ul style="list-style-type: none"> • Girder Depth • Web Plate Length • Flange Plate Width 	 <p><i>B1010 – LOD 200 Railroad Bridge Girder Steel</i></p>
<p>300</p>	<p>Required non-graphic information associated with model elements may include:</p> <ul style="list-style-type: none"> • Thickness of the Flange and Web Plate • Finishes, i.e. painted, galvanized, etc. 	 <p><i>B1010 – LOD 300 Railroad Bridge Girder Steel</i></p>
<p>350</p>	<p>Element modeling to include:</p> <ul style="list-style-type: none"> • Stiffeners • Exact sloping of members • Splits between Plate Girders 	 <p><i>B1010 – LOD 350 Railroad Bridge Girder Steel</i></p>

400	<p>Element modeling to include fabrication level information:</p> <ul style="list-style-type: none">• Welds• Coping of members• Washers, nuts, etc.• Grating, holes in grating• All assembly elements	 <p><i>B1010 – LOD 400 Railroad Bridge Girder Steel</i></p>
-----	---	---

C2010.20 – Precast Structural Stairs (Concrete)

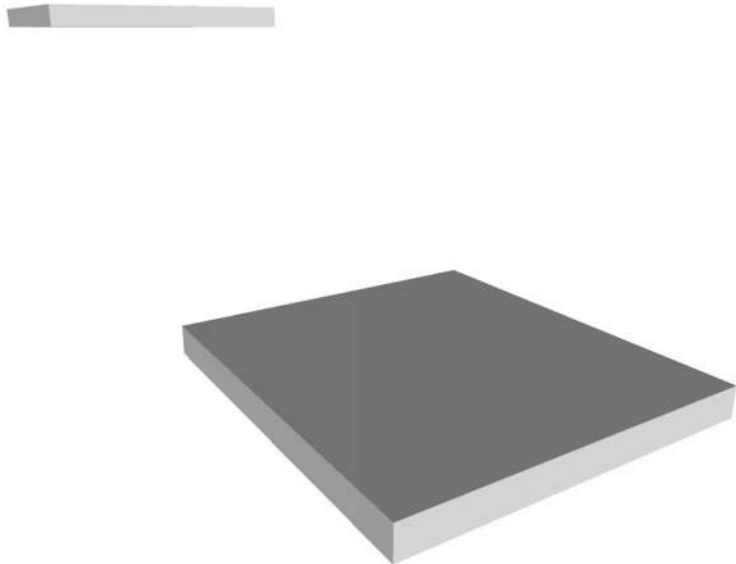
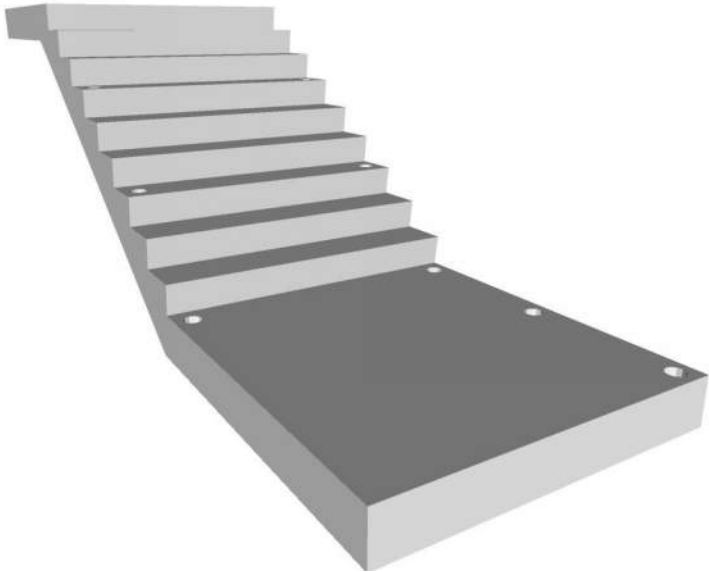
100	See C10	
200	<p>Element modeling to include:</p> <ul style="list-style-type: none"> Type of structural concrete system Approximate geometry (e.g. depth) of structural elements 	 <p><i>C2010.20-LOD 200 Precast Structural Stairs (Concrete)</i></p>
300	<p>Element modeling to include:</p> <ul style="list-style-type: none"> Specific sizes and locations of main concrete structural members modeled per defined structural grid with correct orientation Concrete defined per spec (strength, air entrainment, aggregate size, etc.) All sloping surfaces included in model element with exception of elements affected by manufacturer selection <p>Required non-graphic information associated with model elements includes:</p> <ul style="list-style-type: none"> Penetrations for items such as MEP Finishes, camber, chamfers, etc. Typical details Embeds and anchor rods Aggregate, clear clover Reinforcing spacing Reinforcing Live loads 	 <p><i>C2010.20-LOD 300 Precast Structural Stairs (Concrete)</i></p>

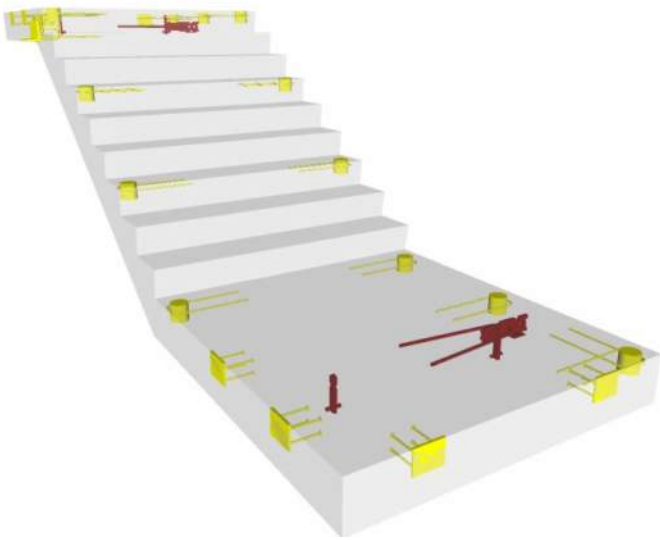
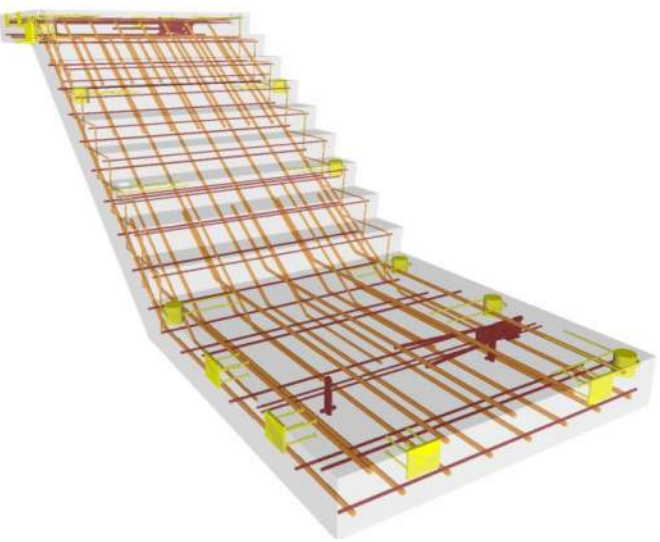
350	<p>Element modeling to include:</p> <ul style="list-style-type: none">• Reinforcing Post-tension profiles and strand locations• Reinforcement called out, modeled if required by the BIMXP, typically only in congested areas• Pour joints and sequences to help identify reinforcing lap splice locations, scheduling, etc.• Expansion Joints• Lifting devices• Embeds and anchor rods• Post-tension profile and strands modeled if required by the BIMXP• Penetrations for items such as MEP• Any permanent forming or shoring components	 <p><i>C2010.20-LOD 350 Precast Structural Stairs (Concrete)</i></p>
400	<p>Element modeling to include:</p> <ul style="list-style-type: none">• All reinforcement including post tension elements detailed and modeled• Finishes, camber, chamfer, etc.	 <p><i>C2010.20-LOD 400 Precast Structural Stairs (Concrete)</i></p>

F1110 - Special Structures: Pre-engineered Metal Building Structures

100	<p>Generic mass of special structure with system typically noted with a design narrative for conceptual pricing.</p> <p>Other non-graphic information may be included such as:</p> <ul style="list-style-type: none">• Building Width• Building Length• Eave Height	 <p><i>F1110-LOD 200 Metal Building Framing</i></p>
-----	---	---

F1110 - Special Structures: Pre-engineered Metal Building – Rafter, Frames, and Columns

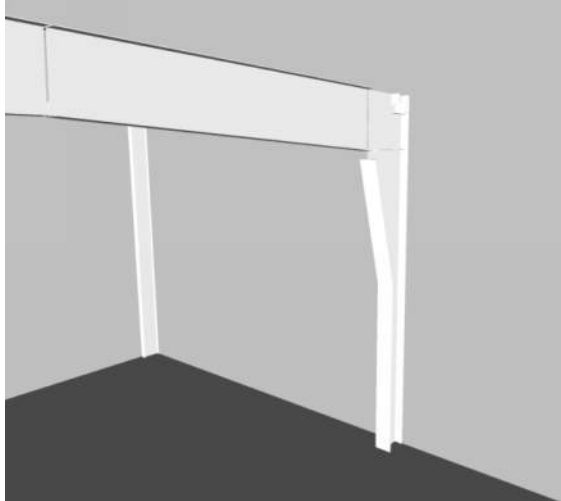
200	<p>Generic mass of rafter frame with a design narrative for conceptual pricing.</p>	 <p><i>F1110-LOD 200 Metal Building Framing - Rafter Frames and Columns</i></p>
-----	---	---

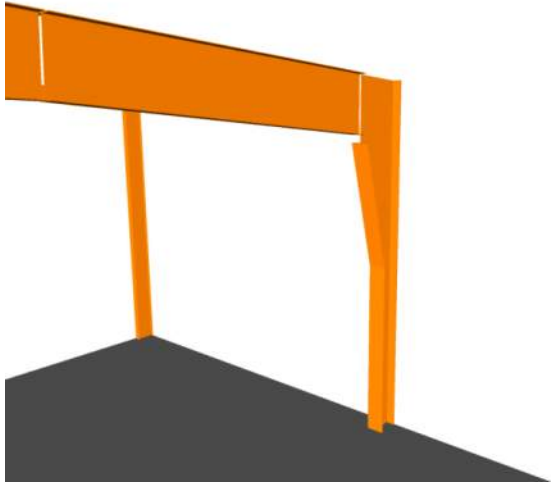
<p>300</p>	<p>Element modeling to include:</p> <ul style="list-style-type: none">• Column base grid line intersections.• Specific sizes of rafter frame structural members, all with correct orientation• Structural steel materials defined. <p>Required non-graphic information associated with model elements may include:</p> <ul style="list-style-type: none">• Connection details• Finishes, i.e. painted, galvanized, et	 <p><i>F1110-LOD 300 Metal Building Framing - Rafter Frames and Columns</i></p>
------------	--	---

350

Element modeling to include:

- Base plate locations with anchor rods and required design forces.
- All member bracing for rafter frame
- Large elements of typical connections applied to all structural steel connections such as base plates, gusset plates, anchor rods, etc.
- Any miscellaneous steel members with correct orientation required for the rafter frame structure or Columns.
- Any steel structure reinforcement such as web stiffeners, sleeve penetrations, etc. required for coordination.

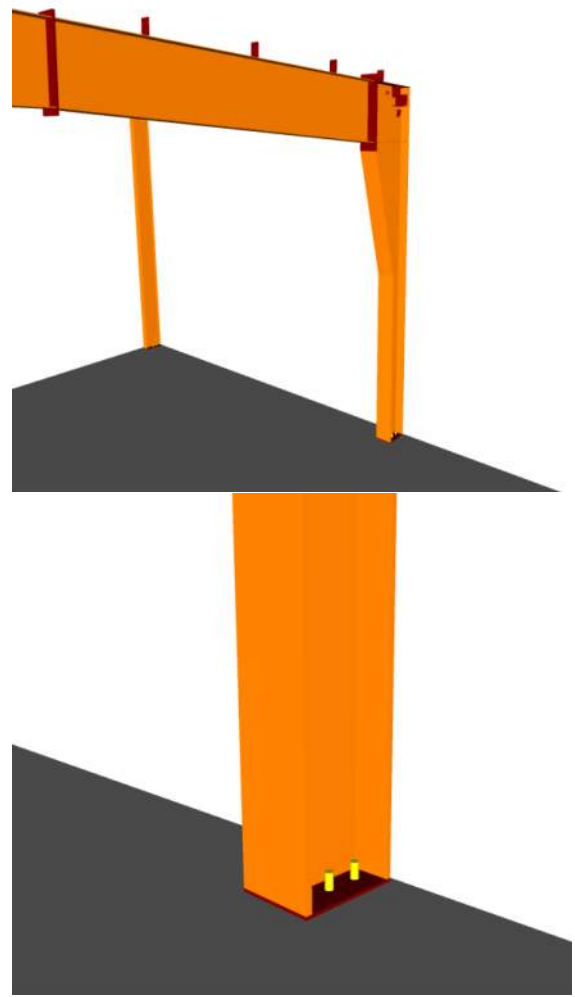

*F1110-LOD 350 Metal Building Framing - Rafter
Frames and Columns*

400

Element modeling to include fabrication level information:

- Welds
- Coping of members
- Washers, nuts, etc.
- All assembly elements

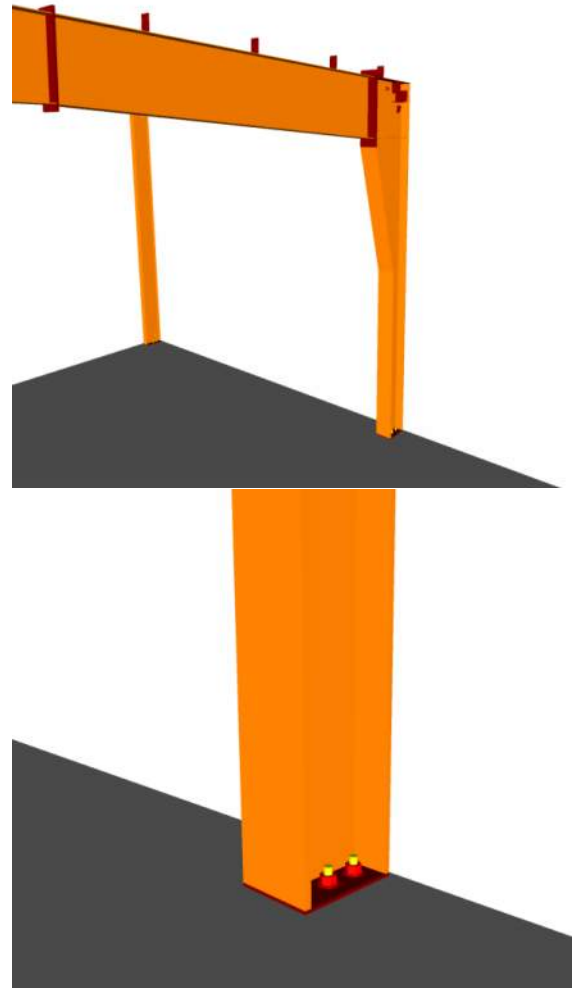

F1110-LOD 400 Metal Building Framing - Rafter Frames and Columns

F1110 - Special Structures: Pre Engineered Metal Buildings –
Components and Cladding

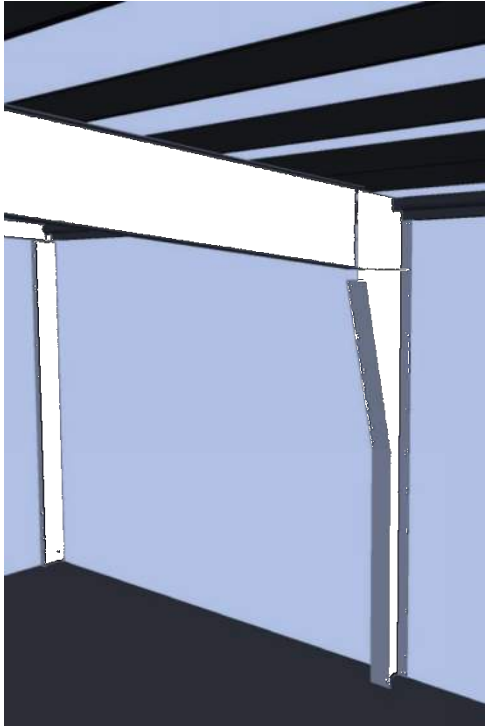
200	<p>Generic mass of special structure with system typically noted with a design narrative for conceptual pricing.</p> <p>Other non-graphic information may be included such as:</p> <ul style="list-style-type: none">• Building Width• Building Length• Eave Height	 <p><i>F1110-LOD 200 Metal Building Framing - Components and Cladding</i></p>
-----	---	--

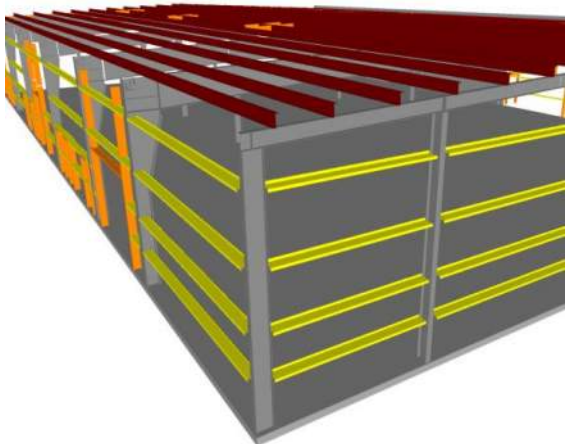
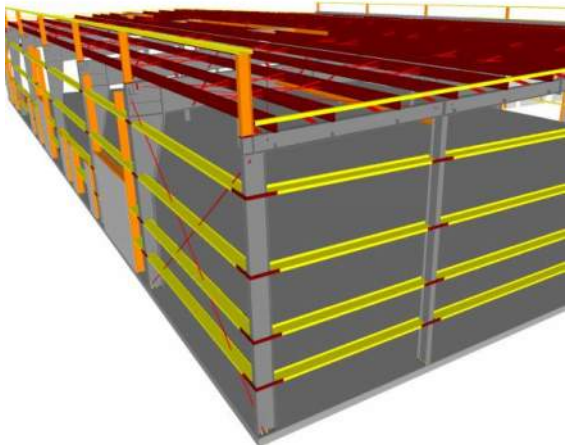
<p>300</p>	<p>Rafter and Column element modeling to include:</p> <ul style="list-style-type: none"> • Specific sizes of main structural members, mass for open web, all with correct orientation • Structural steel materials defined. • The following Pre-Engineering Metal Building components are shown related to main members. <ul style="list-style-type: none"> ○ Endwall or Wind Column ○ End Frame main members ○ Module or Interior Columns ○ Frames & Main Members ○ Columns ○ Rafters ○ Gable members ○ Ridge ○ Purlins ○ Framed Opening (Jambs, Headers, etc) ○ Window Sub-frames ○ Eave Strut ○ Sidewall Girts ○ Walk Door Sub-Frames ○ Endwall Girts <p>Required non-graphic information associated with model elements may include:</p> <ul style="list-style-type: none"> • Connection details • Finishes, i.e. painted, galvanized, et 	 <p><i>F1110-LOD 300 Metal Building Framing - Components and Cladding</i></p>
<p>350</p>	<p>Element modeling to include:</p> <ul style="list-style-type: none"> • All member bracing • Endwall Rod Bracing • Roof Rod Bracing • Sidewall Rod Bracing • Large elements of typical connections applied to all structural steel connections such as base plates, gusset plates, anchor rods, etc. • Any miscellaneous steel members with correct orientation • Any steel structure reinforcement such as web stiffeners, sleeve penetrations, etc. • For bar joist, see Steel Open Web Joists LOD. 	 <p><i>F1110-LOD 350 Metal Building Framing - Components and Cladding</i></p>

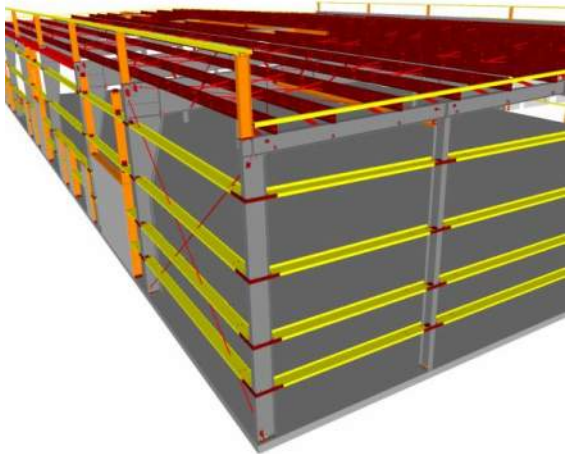
400	<p>Element modeling to include fabrication level information:</p> <ul style="list-style-type: none">• Welds• Coping of members• Washers, nuts, etc.• SSR Clips• Thermal Spacers• Closers• Cinch Straps• Eave plate/backup plates• Cladding texture and color• All assembly elements	 <p><i>F1110-LOD 400 Metal Building Framing - Components and Cladding</i></p>
-----	--	---